

HE
18.5
.A37
no.
DOT-
TSC-
UMTA-
84-35



U.S. Department
of Transportation

Urban Mass
Transportation
Administration

ACCESS: Brokering Paratransit Services to the Elderly and Handicapped in Allegheny County, PA

UMTA/TSC Evaluation Series

Final Report
December 1984



UMTA Technical Assistance Program

NOTICE

This document is disseminated under the sponsorship of the Department of Transportation in the interest of information exchange. The United States Government assumes no liability for its contents or use thereof.

NOTICE

The United States Government does not endorse products or manufacturers. Trade or manufacturers' names appear herein solely because they are considered essential to the object of this report.

HE
18.5
.A37
no.
DOT-
TSC-
UMTA-
64-35

1. Report No. UMTA-MA-06-0049-84-10		2. Government Accession No.		3. Recipient's Catalog No.	
4. Title and Subtitle ACCESS, BROKERING PARATRANSIT SERVICES TO THE ELDERLY AND HANDICAPPED IN ALLEGHENY COUNTY, PA				5. Report Date December 1984	
				6. Performing Organization Code DTS-64	
7. Author(s) Lovely, Mary E.				8. Performing Organization Report No. DOT-TSC-UMTA-84-35	
9. Performing Organization Name and Address Charles River Associates, Inc.* 200 Clarendon Street Boston, MA 02116				10. Work Unit No. (TRAIS) UM527/R5631	
				11. Contract or Grant No. DOT-TSC-1757	
12. Sponsoring Agency Name and Address U.S. Department of Transportation Urban Mass Transportation Administration Office of Management Research and Transit Services Service and Methods Demonstration Division Washington, DC 20590				13. Type of Report and Period Covered Final Report February 1979 - July 1982	
				14. Sponsoring Agency Code URT-31	
15. Supplementary Notes *Under contract to:		U.S. Department of Transportation Research and Special Programs Administration Transportation Systems Center Cambridge, MA 02142			
16. Abstract <p>This report describes and evaluates the elderly and handicapped brokerage project sponsored by UMTA's Service and Methods Demonstration Program. The demonstration, sponsored locally by the Port Authority of Allegheny County, tests the concept of transportation brokerage on a large scale. During the demonstration, the broker, ACCESS, coordinated service delivery by for-profit and not-for-profit carriers and arranged service provision to human service agencies and unaffiliated individuals. The broker also administered and organized service delivery for a user-side subsidy program funded by the Port Authority. This program is available to Allegheny County residents who are unable to board fixed-route buses, and it represents the Authority's special efforts to meet Section 504 requirements for service to the handicapped.</p> <p>The report describes the planning efforts that led to the demonstration and the objectives of the sponsors in funding the project. It describes in detail how the broker has organized service delivery as well as administrative functions. It includes an evaluation of the impact of the broker on paratransit supply and an examination of participation by human service agencies. Using the results of extensive surveys of ACCESS users, the report contains information on the number and characteristics of the elderly and handicapped and the extent to which they use project services. Finally, the report provides an assessment of the brokerage concept and its transferability to other localities.</p>					
17. Key Words Transportation, Brokerage, Para-transit, Elderly and Handicapped, Travel Diary, User-Side Subsidy, Social Service Agency Coordination, Service and Methods Demonstration			18. Distribution Statement DOCUMENT IS AVAILABLE TO THE PUBLIC THROUGH THE NATIONAL TECHNICAL INFORMATION SERVICE, SPRINGFIELD, VIRGINIA 22161		
19. Security Classif. (of this report) Unclassified		20. Security Classif. (of this page) Unclassified		21. No. of Pages 262	22. Price

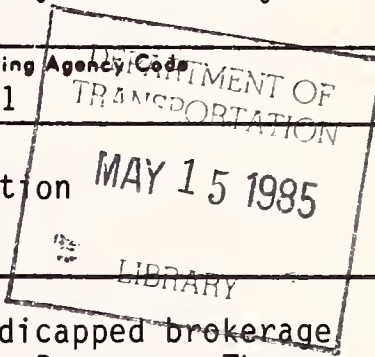

PREFACE

This evaluation was prepared by Charles River Associates Incorporated (CRA) for the Transportation Systems Center (TSC) of the U.S. Department of Transportation. It is part of the Service and Methods Demonstration (SMD) Program, sponsored by the Urban Mass Transportation Administration (UMTA). Bruce D. Spear of TSC served as technical monitor and Mary Martha Churchman was the UMTA project manager.

Within CRA, Mary E. Lovely prepared the report, with the assistance of Sarah Slaughter, Thomas Parody, and Paul Mason. Daniel Brand also assisted in and supervised the preparation of this report, as CRA's Officer-in-Charge of work conducted for the SMD program. CRA acknowledges the valuable contributions of TSC and UMTA technical staffs to the demonstration evaluation.

Although CRA accepts full responsibility for the information and conclusions contained in this case study, many other people contributed to it. Ervin Roszner, of ACCESS Transportation Systems, and William Millar and Thomas Letky, of the Port Authority of Allegheny County, participated in the evaluation process and supplied information essential to describing the history and design of the program. We are also indebted to the numerous carrier and human service representatives who responded to our requests for interviews or the completion of surveys.

METRIC CONVERSION FACTORS

Approximate Conversions to Metric Measures

Symbol	When You Know	Multiply by	To Find	Symbol
LENGTH				
in	inches	2.5	centimeters	cm
ft	feet	30	centimeters	cm
yd	yards	0.9	meters	m
mi	miles	1.6	kilometers	km
AREA				
m ²	square inches	6.5	square centimeters	cm ²
ft ²	square feet	0.09	square meters	m ²
yd ²	square yards	0.8	square meters	m ²
mi ²	square miles	2.5	square kilometers	km ²
ac	acres	0.4	hectares	ha
MASS (weight)				
oz	ounces	28	grams	g
lb	pounds	0.45	kilograms	kg
	short tons (2000 lb)	0.9	tonnes	t
VOLUME				
teaspoon	teaspoons	5	milliliters	ml
Tablespoon	tablespoons	15	milliliters	ml
fl oz	fluid ounces	30	milliliters	ml
c	cups	0.24	liters	l
pt	pints	0.47	liters	l
qt	quarts	0.95	liters	l
gal	gallons	3.8	liters	l
ft ³	cubic feet	0.03	cubic meters	m ³
yd ³	cubic yards	0.76	cubic meters	m ³
TEMPERATURE (exact)				
°F	Fahrenheit temperature	5/9 (after subtracting 32)	Celsius temperature	°C

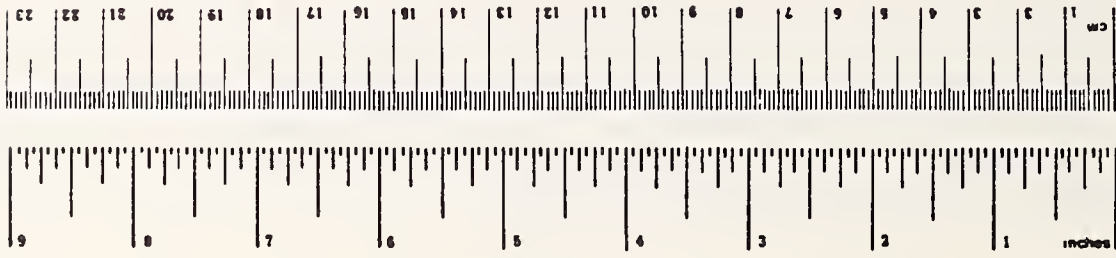

Approximate Conversions from Metric Measures

Symbol	When You Know	Multiply by	To Find	Symbol
LENGTH				
mm	millimeters	0.04	inches	in
cm	centimeters	0.4	inches	in
m	meters	3.3	feet	ft
m	meters	1.1	yards	yd
km	kilometers	0.6	miles	mi
AREA				
cm ²	square centimeters	0.16	square inches	in ²
m ²	square meters	1.2	square yards	yd ²
km ²	square kilometers	0.4	square miles	mi ²
ha	hectares (10,000 m ²)	2.5	acres	ac
MASS (weight)				
g	grams	0.035	ounces	oz
kg	kilograms	2.2	pounds	lb
t	tonnes (1000 kg)	1.1	short tons	lb
VOLUME				
ml	milliliters	0.03	fluid ounces	fl oz
l	liters	2.1	pints	pt
l	liters	1.06	quarts	qt
l	liters	0.26	gallons	gal
m ³	cubic meters	36	cubic feet	ft ³
m ³	cubic meters	1.3	cubic yards	yd ³
TEMPERATURE (exact)				
°C	Celsius temperature	9/5 (then add 32)	Fahrenheit temperature	°F

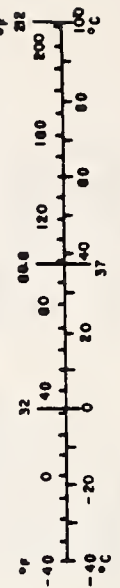

TABLE OF CONTENTS

<u>Section</u>	<u>Page</u>
EXECUTIVE SUMMARY	xiii
1. DEMONSTRATION OVERVIEW	1
1.1 Description of the Project.	1
1.2 Demonstration Planning.	3
1.2.1 Pre-Implementation Planning	3
1.2.2 Regulatory Issues	6
1.3 Demonstration Objectives.	8
1.3.1 Objectives of the Port Authority for the Demonstration	8
1.3.2 Objectives of the Service and Methods Demonstration Program for the Demonstration .	9
2. DEMONSTRATION SETTING.	12
2.1 Allegheny County's Elderly and Handicapped Population.	12
2.2 Physical Characteristics of Allegheny County.	14
2.3 Providers and Purchasers of Transportation for the Elderly and Handicapped	17
2.4 Summary	19
3. SERVICE DELIVERY AND ADMINISTRATIVE STRUCTURE.	20
3.1 Service Delivery.	20
3.1.1 Contracting for Providers	21
3.1.2 Service Sectors	22
3.1.3 Terms of Compensation	24
3.1.4 Insurance	24
3.1.5 Vehicle Standards	25
3.1.6 Driver Requirements and Training.	25
3.1.7 ACCESS Fare System.	26
3.1.8 Scheduling and Dispatching.	29
3.2 Administrative Structure.	33
3.2.1 Carrier Solicitation, Negotiation, and Liaison	33

TABLE OF CONTENTS (Continued)

<u>Section</u>	<u>Page</u>
3.2.2 Agency Marketing and Liaison	34
3.2.3 Trip Scheduling	34
3.2.4 Telephone Inquiries and Referrals	35
3.2.5 Scrip Sales and Accounting.	35
3.2.6 Accounts Payable and Receivable	35
3.2.7 Complaint Management.	40
3.2.8 Port Authority User-Side Subsidy Management .	41
3.3 Administrative Organization and Costs	43
3.3.1 ACCESS Staff.	43
3.3.2 Broker Administrative Costs	44
3.4 Cost of the Broker and User-Side Subsidy Program to the Port Authority	45
3.5 Demonstration Grant Expenditures.	48
4. IMPACT OF THE DEMONSTRATION ON PARATRANSIT SUPPLY.	50
4.1 Pre-Implementation Transportation System Characteristics	50
4.1.1 Port Authority of Allegheny County.	50
4.1.2 PUC-Authorized, For-Profit Carriers	51
4.1.3 Not-For-Profit Human Service Agency Carriers.	53
4.1.4 PUC-Authorized, Not-For-Profit Carrier.	57
4.1.5 Availability of Paratransit Before Broker Implementation	59
4.2 Desired Impacts of the Broker on Paratransit Supply .	60
4.3 Influence of the Broker on the Paratransit Industry .	64
4.3.1 The Reduction of Regulatory Barriers and the Promotion of Competition.	64
4.3.2 Coordination of For-Profit and Not-For-Profit Carriers	71
4.3.3 Improvements in Service Quality and Quantity.	74
4.4 Influence of the Broker on Vehicle Productivity, Service Quality, and Transportation Costs	78

TABLE OF CONTENTS (Continued)

<u>Section</u>	<u>Page</u>
4.4.1	Vehicle Productivity 79
4.4.2	Service Quality 81
4.4.3	ACCESS Transportation Costs 84
5.	IMPACT OF THE DEMONSTRATION ON HUMAN SERVICE AGENCIES. 87
5.1	Desired Impacts of Coordination 87
5.2	Marketing ACCESS Service to Agencies. 88
5.3	Cost of ACCESS Service to the AAA 90
5.4	Agencies' Use of and Attitudes Toward ACCESS Service 96
5.4.1	Human Service Agencies and Their Transportation Programs 97
5.4.2	Characteristics of ACCESS-Affiliated Agencies and Their Use of the ACCESS System. 102
5.5	Summary 110
6.	THE ELDERLY AND HANDICAPPED POPULATION AND ITS USE OF ACCESS SERVICES. 113
6.1	Incidence of the Elderly and the Transportation- Handicapped in the General Population 114
6.2	Comparison of ACCESS Registrants and Nonregistrants . 118
6.3	Use of ACCESS by Registrants and Its Effect on Their Travel Behavior 128
6.3.1	Reasons for Using ACCESS and the Convenience of Registering. 128
6.3.2	Frequency and Purpose of ACCESS Usage 131
6.3.3	Opinions About ACCESS Service Quality 137
6.3.4	Changes in Travel Behavior. 141
6.4	The Ability of ACCESS Registrants and Nonregistrants to Use Lift-Equipped Buses. 149
6.5	Summary 151
7.	CONCEPT FEASIBILITY AND TRANSFERABILITY. 153
7.1	Results in Meeting the Objectives of the Port Authority 153
7.2	Results in Meeting the Objectives of the Service and Methods Demonstration Program 155

TABLE OF CONTENTS (Continued)

<u>Section</u>	<u>Page</u>
7.2.1 Overcoming Regulatory and Institutional Barriers	155
7.2.2 Administrative Procedures and Costs	156
7.2.3 Effectiveness in Improving Service Quality.	157
7.2.4 Effect of the Broker on Transportation Costs.	157
7.2.5 Response of Human Service Agencies.	158
7.2.6 Effect of the Broker on the Transportation-Handicapped	160
APPENDIX A - ACCESS CARRIER VEHICLE INSPECTION PROGRAM.	A-1
APPENDIX B - MATERIALS FOR ACCESS DRIVER SENSITIVITY TRAINING PROGRAM.	B-1
APPENDIX C - PROMOTIONAL MATERIALS SENT BY ACCESS TO AGENCIES	C-1
APPENDIX D - HUMAN SERVICE AGENCY SURVEYS	D-1
Survey of Agencies Affiliated with ACCESS.	D-2
Survey of Agencies Not Affiliated with ACCESS.	D-16
Survey of Agencies Formerly Affiliated with ACCESS	D-28

LIST OF ILLUSTRATIONS

<u>Figure</u>		<u>Page</u>
2-1	DENSITY OF ELDERLY PERSONS IN ALLEGHENY COUNTY, 1970	15
2-2	DENSITY OF NON-AMBULATORY PERSONS, 1970.	16
3-1	SECTOR DIVISIONS USED FOR ACCESS CARRIER BIDDING IN 1979 . .	23
3-2	ACCESS DRIVER RESPONSIBILITIES	27
3-3	ACCESS FARE ZONES.	28
3-4	ACCESS FULL-FARE AND DISCOUNTED SCRIP TICKETS.	30
3-5	BACK AND FRONT OF ACCESS CARD FOR SUBSIDIZED USERS	31
3-6	ACCESS CARRIER INVOICE	36
3-7	ACCESS DRIVER MANIFEST FOR DEDICATED VEHICLES.	38
3-8	ACCESS CHARGE SLIP FOR NON-DEDICATED VEHICLES.	39
3-9	ACCESS PROMOTIONAL MATERIAL EXPLAINING SUBSIDY ELIGIBILITY .	42
4-1	SERVICE AREAS OF TAXI COMPANIES PROVIDING PARATRANSIT SERVICE, 1977.	54
4-2	ALLEGHENY COUNTY ADULT SERVICES/AREA AGENCY ON AGING TRANSPORTATION SERVICE NETWORK, 1977	55
4-3	ALLEGHENY COUNTY MENTAL HEALTH/MENTAL RETARDATION PROGRAM TRANSPORTATION SERVICE NETWORK, 1977	56
4-4	GEOGRAPHIC SERVICE AREAS OF ACCESS CARRIERS, 1979.	68
4-5	GEOGRAPHIC SERVICE AREAS OF ACCESS CARRIERS, 1983.	69
4-6	NUMBER OF TRIPS PROVIDED BY FOR-PROFIT CARRIERS AND NOT-FOR-PROFIT CARRIERS.	73
4-7	ACCESS PASSENGER TRIPS PER VEHICLE HOUR, BY MONTH.	82
5-1	TOTAL AGENCY-SPONSORED PASSENGER TRIPS BY TIME PERIOD AND DAY OF WEEK.	100

LIST OF ILLUSTRATIONS (Continued)

<u>Figure</u>		<u>Page</u>
6-1	PERCENTAGE OF ACCESS REGISTRANTS AND NONREGISTRANTS, BY FUNCTIONAL DIFFICULTY	122
6-2	PERCENTAGE OF ACCESS REGISTRANTS AND NONREGISTRANTS, BY TYPE OF MOBILITY AID USED	123
6-3	NUMBER OF TRIPS BY TYPE OF SUBSIDY	144

LIST OF TABLES

<u>Table</u>		<u>Page</u>
2-1	CHARACTERISTICS OF ALLEGHENY COUNTY, PENNSYLVANIA	13
3-1	MONTHLY ACCESS COSTS FOR FISCAL PERIODS, 1980-1982.	46
3-2	BROKER EXPENSES, REVENUES, AND USER-SIDE SUBSIDY REIMBURSEMENTS	47
3-3	BREAKDOWN OF ACCESS DEMONSTRATION PROJECT FUNDS	49
4-1	CHARACTERISTICS OF FOR-PROFIT CARRIERS INVOLVED IN PARATRANSIT FOR THE ELDERLY AND HANDICAPPED, 1977	52
4-2	CHARACTERISTICS OF TRANSPORTATION SERVICES PROVIDED BY TWENTY-FIVE AGENCIES IN ALLEGHENY COUNTY (1977)	58
4-3	CHARACTERISTICS OF ACCESS CARRIER FLEETS, JUNE 1982	75
4-4	SERVICE HOURS OF ACCESS CARRIERS.	77
4-5	COMPARISON OF PARATRANSIT SERVICE QUALITY FOR THREE TIME PERIODS.	83
4-6	AVERAGE ACCESS MONTHLY TRIPS, TRANSPORTATION COSTS, ADMINISTRATIVE COSTS, AND TOTAL COSTS, BY FISCAL PERIOD	85
5-1	ACCESS RATES FOR SERVICE TO THE AAA	93

LIST OF TABLES (Continued)

<u>Table</u>		<u>Page</u>
5-2	ORGANIZATIONAL STRUCTURE OF ALLEGHENY COUNTY HUMAN SERVICE AGENCIES.	98
5-3	PERCENTAGE OF AGENCIES, BY USE OF VEHICLE FUNDING SOURCE. .	101
5-4	PERCENTAGE OF AGENCIES SERVING VARIOUS CLIENT GROUPS, BY AFFILIATION WITH ACCESS.	103
5-5	TRANSPORTATION ARRANGEMENTS OF AGENCIES SURVEYED, BY AFFILIATION WITH ACCESS.	105
5-6	PURPOSES FOR WHICH ACCESS-AFFILIATED AGENCIES PROVIDE TRANSPORTATION, BY VARIOUS TYPES OF SERVICE	106
5-7	COMPARISON BY ACCESS-AFFILIATED AGENCY MANAGERS OF VARIOUS ACCESS SERVICE CHARACTERISTICS TO PREVIOUS SERVICE.	108
5-8	OPINIONS OF ACCESS-AFFILIATED AGENCY MANAGERS ABOUT THE BENEFITS OF ACCESS SERVICE	109
5-9	OPINIONS OF NON-AFFILIATED AGENCY MANAGERS REGARDING COORDINATION OF THEIR AGENCY TRANSPORTATION PROGRAMS . . .	111
6-1	ESTIMATED NUMBER OF PERSONS AND INCIDENCE IN THE GENERAL POPULATION, BY AGE GROUP AND ABILITY TO USE PUBLIC TRANSPORTATION	115
6-2	SOCIOECONOMIC CHARACTERISTICS OF THE TRANSPORTATION- HANDICAPPED POPULATION	117
6-3	ACCESS PARTICIPATION, BY GROUP	120
6-4	SOCIOECONOMIC CHARACTERISTICS OF ACCESS REGISTRANTS AND NONREGISTRANTS	124
6-5	VARIOUS HOUSEHOLD CHARACTERISTICS BY GROUP: GENERAL POPULATION, ABLE-BODIED ELDERLY, TRANSPORTATION-HANDICAPPED NONREGISTRANTS, AND ACCESS REGISTRANTS	127
6-6	REASONS CITED BY NONREGISTRANTS FOR NOT PARTICIPATING IN THE ACCESS PROGRAM.	129

LIST OF TABLES (Continued)

<u>Table</u>		<u>Page</u>
6-7	STATED REASON FOR USING ACCESS	130
6-8	HOW ACCESS REGISTRANTS HEARD ABOUT ACCESS AND THEIR OPINIONS ABOUT THE CONVENIENCE OF REGISTERING.	132
6-9	TIME PERIOD SINCE LAST ACCESS TRIP	133
6-10	PERCENTAGE OF ACCESS REGISTRANTS USING ACCESS DURING PAST YEAR, BY AGE GROUP.	133
6-11	PERCENTAGE OF ACCESS REGISTRANTS, BY FREQUENCY OF ACCESS CARD USE.	134
6-12	ACCESS TRIPS AS A PERCENTAGE OF TOTAL TRIPMAKING BY ACCESS REGISTRANTS.	135
6-13	TRIP PURPOSE DISTRIBUTION OF ACCESS TRIPS DURING DIARY WEEK	138
6-14	STATED REASON FOR NOT USING ACCESS MORE OFTEN	139
6-15	OPINIONS OF ACCESS REGISTRANTS ABOUT VARIOUS ASPECTS OF SERVICE QUALITY.	140
6-16	SUGGESTED ACCESS SERVICE IMPROVEMENTS	142
6-17	MOST FREQUENT METHOD OF TRAVEL BEFORE ACCESS REGISTRATION .	145
6-18	PREVIOUS TRAVEL MODE USED FOR REGULARLY-SCHEDULED TRIPS CURRENTLY MADE USING ACCESS	146
6-19	PERCEIVED CHANGES IN OTHER THAN MODE CHOICE BECAUSE OF ACCESS	148
6-20	ABILITY TO USE STANDARD AND LIFT-EQUIPPED BUSES, BY GROUP .	150

EXECUTIVE SUMMARY

DESCRIPTION OF THE PROJECT

The Pittsburgh Paratransit Brokerage Program was designed to test the feasibility of coordinating paratransit resources to improve the cost-effectiveness and level of service of specialized transportation for the elderly and handicapped. In the demonstration, paratransit services for the elderly and handicapped were coordinated through the establishment of a paratransit broker or agent in a role analogous to that of a private sector travel agent or real estate broker. The broker brings together willing suppliers and consumers of services, overcomes institutional barriers to the matching of supply with demand, and consummates a sale.

The role of the paratransit broker in Allegheny County was performed by ACCESS Transportation Systems, Incorporated, a wholly-owned subsidiary of Multisystems, Inc., under contract to the Port Authority of Allegheny County.*

The demonstration was conducted in Allegheny County, the metropolitan area surrounding and including the city of Pittsburgh, Pennsylvania. The recipient of the UMTA Service and Methods Demonstration grant was the Port Authority of Allegheny County, operator of the county's public transit service. The UMTA grant was awarded in July 1978, service was implemented in late February 1979, and the demonstration concluded in June 1982. The Port Authority decided to continue funding the project after that date.

As of May 1982, 42 human service agencies had purchased transportation services for their clients through ACCESS, accounting for 34 percent of all trips purchased. Some of these agencies used ACCESS exclusively to serve their clients, while others used the broker in conjunction with their own vehicles or other transportation arrangements.

Individuals not sponsored by a human service agency could also avail themselves of ACCESS service. Anyone 60 years of age or older, or any physically- or mentally-handicapped person of any age was eligible to use ACCESS. The Port Authority provided a 75 percent discount on the cost of the broker's service to people physically unable to board a standard Port Authority Transit vehicle. In May 1982, 61 percent of all trips purchased through ACCESS were taken with the Port Authority user-side subsidy. Those handicapped individuals who are able to board a vehicle paid for ACCESS service at full price. Service provided to full-fare patrons accounted for only 5 percent of all ACCESS trips in May 1982.

*As of April 1982, Multisystems, Inc., became the Multisystems Consulting Division of Multiplications, Inc.

DEMONSTRATION OBJECTIVES

The primary sponsors of the Pittsburgh Paratransit Brokerage Demonstration project were the Port Authority of Allegheny County, which provided local funding for the project, and the Service and Methods Demonstration (SMD) Program of the U.S. DOT, which provided Federal funding. As in all projects sponsored by the SMD Program, the primary objective was to test innovative and promising improvements in transportation provision. A key element of these projects is the dissemination of information about the project as an aid to localities considering similar improvements. One way in which this information is provided is through a thorough evaluation of the innovation.

In this case, the following issues were identified and examined:

- The ability of the broker to overcome regulatory and institutional barriers to coordination;
- The effectiveness of the administrative procedures used by the broker and the cost of performing these functions;
- The effectiveness of the broker in improving the quality of paratransit resources in the community;
- The effect of the broker on the cost of transportation service;
- The response of human service agencies to the broker; and
- The effect of the project on the mobility of the transportation-handicapped population.

The Pittsburgh Paratransit Brokerage Demonstration tested the brokerage concept on a scale unprecedented in previous paratransit brokerage projects. Its scale is distinguished by three important features of Allegheny County -- the size of the potential demand pool, the physical dimensions of the service area, and the number of transportation providers and purchasers to be coordinated by the broker.

In addition, ACCESS was charged with the task of coordinating for-profit and not-for-profit providers into a unified delivery network where -- prior to the broker's intervention -- such cooperation between these two types of providers did not exist. In fact, regulatory action authorizing not-for-profit carriers to provide shared-ride service for passengers other than their clients was vigorously opposed by for-profit carriers.

In forming a unified delivery network, ACCESS was also confronted with the problem of expanding the capacity of for-profit carriers to serve nonambulatory passengers. Part of this task involved sensitizing the carriers and their drivers to the importance of service quality issues when

serving the disabled individual. The broker also had to convince human service agencies of the importance of good record-keeping, efficient scheduling, and productivity in general.

Besides assembling disparate groups of providers, ACCESS was called upon to market its transportation services to a number of different human service agencies that did not represent a cohesive group. Some agencies served the physically handicapped, others served primarily ambulatory elderly persons, and still others served the mentally-handicapped. Many of these agencies were concerned about the comfort of their clients sharing rides with persons from different groups, but such mixing constituted a basic premise of the project -- to coordinate and improve transportation for all elderly and handicapped persons.

ACCESS was also planned as a service for handicapped individuals not affiliated with human service agencies who would use the system for all purposes, with many of their trips being unique. Given these dissimilarities, the broker would be challenged to develop operational systems that could capture any potential cost savings from the coordination of demand by agencies and individuals.

ADMINISTRATIVE PROCEDURES AND COSTS

ACCESS solicits provider services by issuing a request for qualifications (RFQ) annually. Both for-profit and not-for-profit carriers may respond. The RFQ outlines the carrier qualifications necessary for becoming an ACCESS provider. Any carrier that meets these qualifications is eligible to become part of the ACCESS system by submitting a bid to provide service.

Soon after carriers submit qualification statements to ACCESS, the broker requests cost bids for providing service. The for-profit carriers submit bids on a vehicle-hour basis and the not-for-profit carriers submit bids according to the actual hourly cost of providing service. Negotiations with the not-for-profit carriers focus on service quality and improved productivity. Negotiations with for-profit carriers focus on these issues as well as on the level of the bids each carrier makes.

During the first round of carrier contracting in late 1978, ten contracts were initially negotiated and signed between carrier representatives and ACCESS management. After a period of adjustment, the ACCESS network had, by July 1979, stabilized with six carriers providing service, two for-profit and four not-for-profit.

The terms of compensation for for-profit carriers differ from those for not-for-profit carriers. The former, when providing dedicated service (a vehicle used exclusively for ACCESS service) are reimbursed on the basis of a fixed cost per hour out of the garage. Non-dedicated service, mainly taxi

service used by the carrier to provide trips that cannot be made on dedicated vehicles, is purchased by ACCESS at the meter rate regulated by the Public Utility Commission (PUC). Not-for-profit carriers are reimbursed on an actual-cost basis; ACCESS audits of these carriers provide the basis for setting a per-vehicle service-hour rate. Under some circumstances, ACCESS permits the pro-rating of costs of a carrier's vehicle that is used for both ACCESS and non-ACCESS trips.

In addition to negotiating compensation rates, ACCESS sets insurance requirements and manages accounting and invoicing, communications, general administration, and sale of the scrip that may be used by riders. The scheduling of trips requested by human service agencies is performed by the broker. Most other scheduling procedures are performed by the carriers.

IMPACT OF THE DEMONSTRATION ON PARATRANSIT SUPPLY

Pre-Implementation System Characteristics

Prior to the demonstration program, several agencies provided for the transportation needs of Allegheny County's elderly and handicapped.

The Port Authority of Allegheny County, through the Port Authority Transit (PAT), serves all Allegheny County and parts of four neighboring counties, covering an area of nearly 800 square miles and containing a service population of 1.29 million people. As part of its special efforts program for the elderly and handicapped, PAT has:

- Replaced its reduced-fare program with a free-fare program for the elderly, financed by the Commonwealth of Pennsylvania's state lottery proceeds;
- Assigned specially-equipped (non-lift) buses to routes around which high concentrations of elderly and handicapped persons reside;
- Established a training program to sensitize bus drivers to the specific difficulties of disabled riders; and
- Sponsored a program to educate the elderly in the proper use of the transit system and those vehicles designed for their needs.

Despite its efforts, much of PAT's service remains inaccessible to the county's elderly and handicapped individuals. Many of PAT's buses do not have handrails or adequate lighting in the stepwells and none are accessible to persons who cannot use steps. Furthermore, given the hilly Allegheny County terrain, many disabled people cannot reach PAT bus stops, even if they are able to use non-lift-equipped vehicles. Thus, PAT service is not a feasible transportation option for many severely transportation-handicapped individuals.

Complementing the PAT service prior to the demonstration were private, for-profit carriers and human service agencies. Seven private, for-profit taxi operators had been authorized to provide paratransit services in Allegheny County. They operated a total of 710 vehicles in 1977, with a total seating capacity of 7,496 and a total wheelchair capacity of 88.

These carriers, however, served overlapping geographic areas while many areas received no service. Overlapping service areas could be found in the city of Pittsburgh and its southwestern environs. This pattern reflects the higher density of demand for taxi services in these areas. It also reflects the PUC's decision to allow multiple carriers in these localities. The northwestern corner of the county, however, received little or no service.

In addition to these private operators, several human service agencies also provided transportation to the elderly and handicapped. The Allegheny County Adult Services/Area Agency on Aging (AAA) provided funding to both publicly and privately operated not-for-profit outreach centers throughout the county. These centers either supplied service in their own vehicles or purchased service from private carriers. In 1977, transportation was provided directly by 12 of the outreach centers, the costs of which were reimbursed by the AAA. Six centers utilized the AAA-subcontracted service with taxi operators only.

A second major funding source for paratransit was the Allegheny County Mental Health/Mental Retardation/Drug and Alcohol Program (MH/MR). MH/MR contracts with private not-for-profit organizations that operate 11 Catchment Area Centers around the county. In 1977, MH/MR operated its transportation services in much the same manner as the AAA. MH/MR-funded trips were provided with county-owned vehicles (vans and station wagons) with back-up and extra service purchased from for-profit taxi operators.

In addition to these two major funding sources, a multitude of smaller agencies provided special transportation services in 1977. Throughout Allegheny County, at least 53 not-for-profit agencies offered some sort of transportation for their clients (not including AAA and MH/MR centers). These agencies provided transportation either with their own vehicles or through for-profit carriers, as a complement to other services such as nutrition, medical, social, and recreational programs. The service areas of these not-for-profit agencies overlapped geographically but at the same time were very restrictive in that each served a narrowly-defined client group and made trips for particular purposes.

One agency, Magic Carpet - Open Doors for the Handicapped, offered transportation as its sole operation and was certified by the PUC to provide paratransit service for the general public. Magic Carpet was, and continues to be, subsidized by Allegheny County and City of Pittsburgh contributions, and has traditionally supplied service primarily to the elderly and handicapped.

In 1977, Magic Carpet drew its patrons mainly from a limited segment of the city of Pittsburgh. With six wheelchair-accessible vans, Magic Carpet served only a minimal number of ambulatory persons, concentrating its service efforts on the nonambulatory. It operated seven days a week and offered service during the evening hours. Despite its limited service area, Magic Carpet constituted an important and unique resource for Pittsburgh's handicapped population. Unlike human service agency services, which were limited to specific trip purposes, Magic Carpet was available for trips with any purpose. Further, Magic Carpet was subsidized and, unlike private providers, its services were economically accessible to the nonambulatory. In several ways, then, Magic Carpet can be seen as a forerunner of the Port Authority's ACCESS and user-side subsidy programs. It provided a visible, relatively unconstrained, and affordable service for the nonambulatory. Unfortunately, it was only available to a small segment of the Allegheny County population.

We can, then, draw some conclusions about the availability of paratransit supply before the demonstration. It is apparent that both for-profit companies and not-for-profit providers were important in offering services to the elderly and handicapped. Yet, not all areas of the county were well served; taxi paratransit services were not available in large sections of the county. Furthermore, for-profit providers owned only a total of 24 accessible vehicles, sufficient capacity for 88 wheelchair passengers at one time. Services provided by agencies were limited geographically, to particular clients, and for specific trip purposes.

Influence of the Broker on the Paratransit Industry

An important issue studied in the evaluation was the promotion of competition among carriers by the broker. Such promotion is important because competition encourages carriers to produce transportation services at the lowest-possible cost. There were a number of factors that inhibited the broker, ACCESS, from immediately taking advantage of competitive forces: the timing of the resolution of regulatory issues; a lag in the response of paratransit providers to regulatory changes; and the decision of the Port Authority to make service quality the highest priority of the broker. Because of these factors, competition among carriers to provide ACCESS service was slow to develop. Eventually, however, the broker was able to engender competition, as evidenced by the number of carriers participating and changes in carriers' service areas.

From 1979 to 1982, ACCESS relied heavily on two for-profit carriers for service provision. These two carriers joined the ACCESS network at its inception and have historically provided about 65 percent of ACCESS trips. Toward the end of the demonstration, three new existing for-profit providers were allowed to serve the ACCESS network, bringing the total number of ACCESS carriers to 11 by June 1982. These new carriers exerted competitive pressure on the more-established carriers, ultimately helping the broker to reduce its per-trip transportation expenses.

No new paratransit carriers, either for-profit or not-for-profit, entered the market as a result of the demonstration. Two factors may have discouraged new carrier entry. First, taxi companies providing paratransit service often rely on exclusive-use service for a major portion of their business. PUC regulation, which restricts entry into the exclusive-use market, may well have dampened entry by carriers wishing to serve both exclusive-use and shared-ride markets. Second, ACCESS' own carrier evaluation criteria and qualification guidelines may have thwarted entry for several years.

Despite the lack of new firm formation, by 1983 the service areas of ACCESS carriers overlapped to a greater extent than previously, reflecting the more competitive character of ACCESS service provision. Where possible ACCESS allows non-agency-affiliated individuals to choose among carriers serving their area.

One other objective of the demonstration was the coordination of human service agency vehicles with other paratransit resources. ACCESS' experience with this type of coordination suggests that it is more difficult to achieve than was perhaps previously believed. The broker has been successful in attracting only a portion of the human service agency vehicles in the county to its service network, and there is little reason to believe that additional coordination would either prove beneficial for the agencies or have a positive impact on the broker's transportation network.

Only a portion of the county's human service agencies have chosen to participate in the ACCESS network as carriers. Importantly, Magic Carpet, a visible symbol of community support for services to the handicapped, participates. Of the ten agencies providing service in the AAA network, two participate in ACCESS; within the MH/MR network, only one agency is affiliated (and this one provides transportation solely to its own clients); and of the many agencies outside the AAA and MH/MR umbrellas, only one participates in the ACCESS network. Other agencies were originally encouraged to participate (and some expressed interest) but no other agencies have served ACCESS as a carrier.

The number of trips provided by not-for-profit carriers has grown over time, but not to the extent the number of trips by for-profit carriers has. Since March 1981, the number of trips provided by not-for-profit carriers has remained close to 4,000 per month. Since that time, the average number of monthly trips by for-profit carriers has gradually increased, with over 14,000 ACCESS trips served by these carriers in June 1982.

The four not-for-profit carriers that participate actively in ACCESS have developed relationships with the broker that have remained basically unchanged throughout the demonstration. Three of the four carriers indicated in interviews that their relationships with ACCESS were beneficial. They believe that affiliation with ACCESS has allowed them to achieve higher vehicle productivities because they can mix other trip requests with those of their own clients, even though broker affiliation has imposed new demands,

particularly with respect to managing transportation programs. One agency, however, believes that serving ACCESS has done nothing to improve its productivity while it has created additional administrative rules and procedures.

Service quality has clearly benefitted from the demonstration, as evidenced by the following results:

- Prior to the demonstration, the overwhelming majority of agency trips were provided between Monday and Friday during agency business hours. Carriers supplied only a small amount of paratransit service after hours and on weekends. In contrast, most ACCESS trips can be taken between 6:00 a.m. and 12:00 midnight, six days per week, and three carriers provide service 24 hours a day.
- Prior to the demonstration, most paratransit services had a one-day-in-advance reservation requirement. ACCESS has continued this procedure from its inception, and in addition has begun to provide same-day service. This feature allows ACCESS patrons to place trip requests for Monday-through-Friday service with advance notice of two hours. Agencies must still schedule trips one day in advance, however.
- Vehicle productivity changes are difficult to measure because driver manifest data, recorded by taxi drivers, are flawed by incomplete or inconsistent records. In addition, trips served by ACCESS differ in important ways from the agency-sponsored trips served by private carriers prior to the broker demonstration. For example, 17 percent of ACCESS trips in January 1981 and 29 percent of ACCESS trips in December 1981 required the use of a lift. Only slightly more than 1 percent of trips in the "before" sample required the use of a lift. Given these changes in the trips served, it appears that the amount of ridesharing in the ACCESS system is slightly less than that obtained by carriers before the demonstration. However, ACCESS has been able to improve its utilization of dedicated vehicles on a fairly steady basis throughout the demonstration. Further, service quality under the ACCESS system, as measured by on-time performance and directness of trip, appears to be an improvement over the quality of service offered prior to the demonstration. (Of course, a number of other factors are also important determinants of service quality, including driver sensitivity, ease of scheduling trips, and the like. These issues are discussed below.)

During the demonstration the broker was able to reduce the cost of transportation service to its clients. In 1980, the average total cost of an ACCESS trip was \$12.58. By 1982, the average total cost per trip had declined to \$10.35. Expressing these figures in constant 1980 dollars using the Consumer Price Index, the average total cost per ACCESS trip in 1980 was \$12.58, while by 1982 it had dropped to \$7.20.

IMPACT OF THE DEMONSTRATION ON HUMAN SERVICE AGENCIES

Of 116 agencies serving the elderly and handicapped in Allegheny County, 42 used ACCESS service as of May 1982. These agencies contract with the broker to provide transportation to their clients, either as a sole provider or as a complement to agency vehicle operations. Nine other agencies had used ACCESS at one time but are no longer affiliated with the broker.

Impact On AAA Service

The Adult Services/Area Agency on Aging (AAA) is Allegheny County's largest single agency purchaser of transportation services for the elderly. Early in the demonstration, ACCESS management targeted the AAA as a key participant in its efforts to coordinate paratransit resources. The AAA refused to purchase service from the broker until mid-1980, and then only after extensive marketing efforts and discussion.

When the AAA began to purchase service from ACCESS in June 1980, the service demands on the broker grew enormously. The total number of trips requested increased and so did the level of management effort required. In the first few years of the relationship, ACCESS had difficulty in pricing its trips to the AAA and in capitalizing on the increased trip requests to improve vehicle productivity. By July 1983, however, three years after the AAA joined the network, ACCESS was able to make significant reductions in the per-trip rate it offered the AAA.

ACCESS appears to have had a positive effect on other dimensions of service to the AAA. Improvements in service quality, particularly the extension of service to all areas of the county and a marked improvement in the availability of lift-or-ramp equipped vehicles, have aided the AAA in meeting its service mandate. Furthermore, purchasing service through ACCESS has allowed the AAA to reduce the management effort it formerly expended on transportation provision. ACCESS has also assisted the AAA in client and staff education on the use of the transportation system.

Attitudes of ACCESS-Affiliated Agencies

A survey of the 116 agencies serving the elderly and handicapped in Allegheny County yielded 88 responses (both ACCESS users and non-users). The survey showed that 48 percent of the agencies use vehicles either owned or operated by the agency to provide transportation to their clients. Seventy-four percent purchase service from paratransit providers, including ACCESS, for-profit carriers, and Magic Carpet. Thirty-three percent of agencies use volunteers to provide transportation for their clients, often using their own vehicles. Fifteen percent of agencies reimburse clients for their travel expenses, including a number of agencies that provide transit fares only.

A total of 293 vehicles are owned or operated by the 88 responding agencies, the majority of which own 2 or fewer vehicles. Only 10 agencies own or operate more than 4 vehicles, with 5 agencies owning or operating more than 20 vehicles. Of the vehicles owned or operated by agencies, only 29 are ramp- or lift-equipped. Almost half of the vehicles owned or operated are ordinary sedans.

Despite the extensive transportation resources available to agencies, 47 percent of those surveyed indicated that they were unable to serve all of their clients' requests for transportation assistance. The agencies attributed this inability to limitations on the resources available to them to provide transportation. Agencies that rely on volunteers to supply transportation are more likely than others to be unable to provide service to all clients that request it. Fifty-seven percent of all agency trips are group trips, involving two or more persons traveling to the same destination.

The survey showed that the majority of agencies affiliated with ACCESS also operate their own vehicles or purchase transportation services. This fact, combined with data on the trip purposes served by ACCESS, suggests that ACCESS-affiliated agencies are using the broker to provide many of their medical trips, thereby freeing their agency vehicles to enhance their productivity by serving group trips.

The survey also revealed the following attitudes on the part of managers of ACCESS-affiliated agencies:

- Agency managers consistently rated ACCESS service as superior to their previous service in terms of driver sensitivity, complaint procedures, availability of service, service hours, and accessible vehicles.
- The managers rated ACCESS service as equal to or better than their previous service in terms of time spent by clients in the vehicle, vehicle safety, and provision of door-to-door service.
- More than 10 percent of the managers surveyed rated time spent waiting for a vehicle to arrive as excessive compared to previous service. (In fact, no significant difference was found between ACCESS' on-time performance and that of agency vehicles prior to the demonstration. There was a great deal of variation in on-time performance, however, and certain agencies apparently find the late arrival of ACCESS vehicles more of a problem than do others.)
- Most agency managers agree that ACCESS has helped to control agency transportation costs, that trip scheduling and the registering of complaints are easier with ACCESS, and that the broker can negotiate more successfully with carriers than an individual agency can.
- Agency managers agree that their agencies can be more flexible regarding both the amount and timing of the transportation services they provide.

- Agencies rely upon ACCESS as a supplement to, rather than a replacement for, agency vehicles, using the broker to serve trips that are difficult to organize into shared rides.

Attitudes of Non-Affiliated Agencies

Agencies' responses to questions about why they do not use ACCESS support the notion that some agencies have transportation demands that are better met by systems other than ACCESS. First, many non-affiliated agencies schedule trips for their clients without an advance reservation requirement. ACCESS, which generally requires a 24-hour advance reservation, does not meet the needs of these agencies. Second, many non-affiliated agencies provide only limited amounts of service, such as taxi service to or from a nursing home, with these services often being billed directly to the clients. Third, non-affiliated agencies that provide transportation on a regular basis are able to supply a large number of agency trips using agency vehicles or volunteers, and they prefer to supplement these arrangements with purchased taxi service. Non-affiliated agencies that do purchase transportation services purchase only small amounts on average. Typical purchased services include ambulance service, hiring a van for a unique group trip, or hiring school bus service on a regular basis.

The survey also provided evidence regarding the attitudes of managers of non-affiliated agencies toward coordinated services. A number of findings are worth noting:

- Half of the managers believe that some type of coordination would result in lower transportation costs.
- The managers believe that service quality and driver sensitivity would decline with coordination.
- The managers believe that agencies would exercise less control over their transportation programs in a coordinated system.

In contrast, many agency managers that do use ACCESS have found that service quality has improved. This suggests that, while many non-affiliated agencies do not use ACCESS because they are able to satisfy their transportation needs using other arrangements, some agencies may still be uninformed about the actual nature of ACCESS service.

THE ELDERLY AND HANDICAPPED POPULATION AND ITS USE OF ACCESS SERVICES

As part of the demonstration evaluation, a major travel-diary survey was undertaken in Allegheny County. Through this data source, we have been able to estimate the size and characteristics of the county's elderly and

handicapped population. There are an estimated 303,401 elderly and transportation-handicapped individuals in Allegheny County. These groups constitute 20.9 percent of the county population. A subgroup of the elderly and handicapped is unable to board standard Port Authority Transit buses. This latter group numbers an estimated 30,343 persons and comprises 2.1 percent of the county population.

Both elderly and transportation-handicapped persons are eligible to use ACCESS. An estimated 90 to 95 percent of ACCESS participants are drawn from those handicapped individuals who are unable to board a standard bus. This suggests that the availability of the Port Authority's user-side subsidy is a major incentive for participation.

ACCESS registrants constitute an estimated 9.2 percent of those unable to board a standard bus. Survey responses indicate that this relatively low market penetration rate results from the availability of private transportation options for many handicapped persons and from the unawareness of many handicapped individuals that ACCESS exists.

A comparison of ACCESS registrants and nonregistrants indicates that, as a group, ACCESS registrants are more likely to require the use of such mobility aids as wheelchairs, walkers, or canes. They are also, as a group, younger, more likely to be employed or seeking work, and less affluent than are nonregistrants. A larger percentage of ACCESS registrants than nonregistrants are affiliated with human service agencies and receive transportation assistance from an agency.

ACCESS registrants appear to have more limited private transportation options than do either elderly or transportation-handicapped nonregistrants. The households they reside in have fewer automobiles and fewer drivers on average. ACCESS registrants are also less likely than nonregistrants to possess a valid driver's license. All three groups, however, reside in households with smaller average numbers of automobiles and drivers than those of the general public.

ACCESS registrants generally express satisfaction with the transportation services they receive from the broker. Two important areas in which improvement is desired are ease of registering for the service and on-time performance of ACCESS vehicles.

Approximately 20 percent of ACCESS registrants have never used the service or had not done so in the year prior to their being surveyed. Among those who used ACCESS at least once in the year prior to the survey, the average number of one-way ACCESS trips taken per week was 1.9. The range of weekly one-way trips observed was from 0 trips to 15 trips. An estimated 14 percent of ACCESS registrants use ACCESS exclusively for transportation services.

ACCESS trips are most frequently used for work-related travel. This suggests that ACCESS plays a role in opening job opportunities to some handicapped individuals. Medical trips account for the next-highest trip frequency, followed by personal business and school trips. ACCESS also provides a high percentage of so-called "non-essential" trips (non-work/school/medical), reflecting the Port Authority's decision to allow relatively unconstrained use of its user-side subsidy program.

ACCESS appears to have induced two types of travel behavior changes: modal shifts and increased tripmaking. Analyses of the mode used most frequently by registrants prior to ACCESS and of regularly-scheduled trips suggest that the broker has attracted trips formerly made in autos or taxis. ACCESS has also led to increased tripmaking by some of its registrants, with the increase tending to be for discretionary (non-work) trip purposes.

An examination of the potential use of lift-equipped buses by ACCESS-eligible transportation-handicapped individuals was also made. Based on individuals' perceptions of their own abilities, it was determined that the market for lift-equipped buses is limited both by a perceived inability to use the equipment itself and by a perceived inability to reach bus stops.

In conclusion, ACCESS provides valuable transportation service to a small segment of the population. This segment, however, is clearly very much in need of transportation assistance. ACCESS registrants are severely handicapped and have limited private transportation options. They nevertheless include many fully-employed individuals who have a wide variety of desired trip purposes. The broker appears to have had a positive effect on their transportation behavior, both through the transferral of trips from less-preferred modes and through increased tripmaking. Despite the considerable success of ACCESS in assisting the handicapped, however, many transportation-handicapped individuals are still unfamiliar with the program.

CONCEPT FEASIBILITY AND TRANSFERABILITY

This subsection examines the success of the paratransit brokerage demonstration in meeting the goals set for it by the Port Authority of Allegheny County and the Service and Methods Demonstration Program. The goals of the Port Authority were to meet a commitment to the local elderly and handicapped population and to test the feasibility of providing paratransit service instead of accessible buses to satisfy Federal Section 504 requirements for service to the handicapped. The goals of the SMD program are defined by the evaluation issues identified earlier under the "Demonstration Objectives" heading of this executive summary.

First, it was found that the broker was successful in overcoming regulatory and institutional barriers to coordination, but that these barriers influenced the project's timing and had a lasting effect on the

response of the paratransit industry to the broker's attempts to stimulate competition. We also found that the broker's organization and administrative design provided useful models for other localities considering a full-scale transportation broker. With sufficiently large-scale operations and careful management, administrative costs can be kept to a reasonable level.

It was found that the broker has significantly improved the quality of paratransit services and has made continued progress in reducing its transportation costs. Regarding a wide variety of service characteristics, data from driver manifest records, agency manager attitude surveys, and user surveys support the conclusion that ACCESS has improved service quality from that formerly available. Continued improvement in on-time vehicle performance is desired, however, by both agency managers and individual users.

Between 1979 and 1983, the broker made steady and significant progress in reducing its real transportation costs without, it appears, a commensurate decline in service quality. We attribute this gradual but steady improvement to the broker's monitoring of carrier records and its ability to finally stimulate competition among carriers bidding to provide service.

The response of human service agencies has been favorable; a little over one-third of the agencies serving the elderly and handicapped use ACCESS. Those agencies that avail themselves of the broker are generally satisfied with the service they receive and perceive a number of benefits that derive from participation. Those agencies that do not use ACCESS believe they have little to gain from participation. They either receive satisfactory service from existing suppliers or are able to meet their own transportation needs with agency vehicles or volunteers.

It was concluded that ACCESS has made a valuable contribution to improving the mobility of the transportation-handicapped. We found that the broker has been very successful in extending the availability of paratransit service throughout the 728 square miles of Allegheny County. This improved availability can be measured in terms of uniform service quality, accessible vehicles, service hours, and days of operation. We also found, however, that the Port Authority's user-side subsidy program has been essential in making paratransit economically accessible to the handicapped. This subsidy, in conjunction with the broker's service improvements, has apparently been instrumental in inducing both switching by some individuals from less-preferred modes to ACCESS and increased tripmaking for specific purposes.

Finally, we can draw some conclusions about the transferability of these results to other localities. The Pittsburgh Paratransit Brokerage Demonstration provides valuable experience concerning the difficulties and complexities of introducing a full-scale paratransit broker into a complicated regulatory environment. ACCESS' achievements have been substantial, and its organizational design and administrative procedures provide useful models for other areas. In considering the formation of a

paratransit broker, however, localities should carefully assess the characteristics of their local paratransit industry and human service agencies to evaluate potential transportation efficiencies and the level of agency participation. The experience in Pittsburgh underscores the strong influence of existing conditions in shaping the ultimate performance of the broker. We also note the essential contribution of the user-side subsidy program to the broker's success in improving the mobility of a segment of the transportation-handicapped population. Economic barriers to increased tripmaking by the handicapped, like physical barriers, must be confronted by those who advocate paratransit rather than accessible buses to remedy deficiencies in public transportation provision.

1. DEMONSTRATION OVERVIEW

This section provides an overview of the Pittsburgh Paratransit Brokerage Demonstration and its federally-sponsored evaluation. First, we present a brief description of the brokerage project. Next, we discuss the planning that occurred prior to the demonstration and the regulatory issues that surrounded the Port Authority of Allegheny County's application for a Service and Methods Demonstration grant. Finally, we present the objectives that were formulated by the sponsors of the project -- the Port Authority of Allegheny County and the Service and Methods Demonstration Program.

1.1 DESCRIPTION OF THE PROJECT

The Pittsburgh Paratransit Brokerage Program was a Service and Methods Demonstration (SMD) Project sponsored by the Urban Mass Transportation Administration (UMTA) of the U.S. Department of Transportation. It was designed to test the feasibility of coordinating paratransit resources as a strategy for improving the cost-effectiveness and level of service of specialized transportation for the elderly and handicapped. The demonstration was conducted in Allegheny County, the metropolitan area surrounding and including the city of Pittsburgh, Pennsylvania. The recipient of the UMTA Service and Methods Demonstration grant was the Port Authority of Allegheny County, operator of the county's public transit service. The UMTA grant was awarded in July 1978, service was implemented in late February 1979, and the demonstration ended in June 1982. The Port Authority has continued to fund the project after that date.

In the demonstration, paratransit services for the elderly and handicapped were coordinated through the establishment of a paratransit broker or agent. The role of a paratransit broker is analogous to that of a private sector travel agent or real estate broker. The broker brings together willing suppliers and consumers of services, overcomes institutional barriers to the matching of supply with demand, and consummates a sale. The Pittsburgh paratransit broker, operating under contract to the Port Authority, performs six major functions:

1. The broker works to overcome institutional barriers to the coordinated provision of specialized transportation services.
2. It solicits proposals for service delivery from both for-profit and not-for-profit paratransit providers and negotiates contracts with selected carriers.

3. It markets the coordinated system to human service agencies and eligible individuals.
4. It sells scrip (tickets for individuals to use in purchasing trips), provides third-party billing services to agencies, and pays carriers.
5. It monitors the performance of providers and the overall system in accommodating the needs of users.
6. It serves as an information clearinghouse on available transportation services for the elderly and handicapped.

The role of the paratransit broker in Allegheny County is performed by ACCESS Transportation Systems, Incorporated, a wholly-owned subsidiary of Multisystems, Inc., under subcontract to the Port Authority of Allegheny County.* ACCESS is an acronym for Allegheny County Coordinated Effort for Shared-Ride Services.

In its role as a broker for the supply of paratransit services, ACCESS solicits requests for qualifications and competitive bids from licensed for-profit paratransit companies; it also solicits expressions of interest from not-for-profit providers. These providers are audited by ACCESS to establish a cost-reimbursement rate for service provision. From the group of interested and qualified providers, the broker selects carriers to serve loosely-defined subregions of the county.

ACCESS markets its services to a variety of user groups. Human service agencies are important purchasers of its service. As of May 1982, 28 agencies purchased transportation services for their clients through ACCESS, accounting for 34 percent of all trips purchased. Some of these agencies use ACCESS exclusively to serve their clients, while others use ACCESS in conjunction with their own vehicles or other transportation arrangements.

Individuals not sponsored by a human service agency can also make use of ACCESS service. Anyone 60 years of age or older and any physically or mentally handicapped person of any age are eligible to use ACCESS. The Port Authority provides a 75 percent discount on the cost of ACCESS service to people who are physically unable to board a standard Port Authority Transit (PAT) vehicle. Applicants for the discount must appear in person for an evaluation of their ability to board a bus. In May 1982, 61 percent of all trips purchased through ACCESS were taken with the Port Authority discount. Those handicapped individuals who are able to board a vehicle must pay for ACCESS service at full price. Only 5 percent of ACCESS trips are taken at full price.

*As of April 1982, Multisystems, Inc. became the Multisystems Consulting Division of Multiplications, Inc.

Since June of 1982, the Commonwealth of Pennsylvania, which sponsors a reduced-fare program for elderly users of demand-responsive services, has been a purchaser of ACCESS service. In Allegheny County, ACCESS is a designated provider of trips taken under this program. The discount is known locally as the "65-Plus" Program, and it is available only to persons 65 years of age or older. Using state lottery revenues, the Commonwealth pays 75 percent of the cost of an elderly person's ACCESS trip. The remainder of the trip cost is paid either by the individual directly or by a human service agency. Because agency-sponsored trips are eligible for the subsidy, the 65-Plus Program effectively lowers the cost of ACCESS service for many agencies as well as many elderly individuals. The program began after the UMTA demonstration project officially ended. This demonstration report, therefore, does not contain evaluation findings concerning the 65-Plus Program.

With one exception, ACCESS trips are priced according to a zonal fare system that establishes a uniform fare for all trips within a given zone and a schedule of computed fares for all trips between zones. The fare system was originally devised with the goal of covering the total transportation costs incurred by ACCESS. Transportation costs were higher than expected, however, and during the demonstration, the broker operated at a deficit. Some of this deficit was funded by a scrip-risk account set up as part of the UMTA Service and Methods Demonstration grant. Since its depletion, the Port Authority has provided the necessary funding. The broker's administrative costs were also paid for by the demonstration grant, although the long-range goal of the service has always been to become totally self-supporting by fares and the Port Authority's user-side subsidy.

ACCESS service was phased in gradually during the demonstration. Initially, service was available only Monday through Friday, between 6:30 a.m. and 10:30 p.m. As demand patterns became clearer, Saturday and Sunday service was established and service hours were extended from 6:00 a.m. to 12:00 midnight. A one-day-in-advance reservation is required for most ACCESS services. Beginning in June 1981, ACCESS provided service, as available, on a two-hours-in-advance reservation basis. This two-hour service is only available to unaffiliated users (i.e., those who are not agency-sponsored).

1.2 DEMONSTRATION PLANNING

1.2.1 Pre-Implementation Planning

Planning for the Pittsburgh Brokerage Demonstration began in July 1975 when the Urban Systems Institute of the School of Urban and Public Affairs at Carnegie-Mellon University undertook an investigation of the potential for

coordinated paratransit services in the Pittsburgh region. The project was partially supported by the U.S. Department of Transportation (U.S. DOT). Carnegie-Mellon examined the possibility of providing paratransit services to the general population as well as to transportation-disadvantaged groups. Because of the complex regulatory issues involved in providing paratransit services and the large numbers of potential suppliers and purchasers, the creation of a broker/agent was suggested. The investigation's findings emphasized that the broker should not be an operator of paratransit services, but rather a facilitator of matches between supply and demand.

Various organizations were considered as potential broker/agents, including the Southwestern Pennsylvania Regional Planning Commission (SPRPC), which is the regional planning organization; the Port Authority of Allegheny County; and existing privately-owned transportation companies. The creation of a separate corporation was also considered. A primary concern was that the agent's role not be in conflict with any existing roles of its organizational home. Otherwise, the Carnegie-Mellon study warned, the broker's management of system transactions would appear suspect or open to conflict of interest. The study recommended that:*

1. The agent should be independent of any particular modal operation; that is, the agent should not be a carrier.
2. The agent should not be engaged in overall transportation systems planning or subsidization.

Since SPRPC, the Port Authority, and existing transportation companies did not fulfill these conditions, the study suggested the creation of a new organization as the best alternative.

In April 1976, Carnegie-Mellon's Urban Systems Institute received a grant from the SMD Program of the Urban Mass Transportation Administration to refine the concept of a paratransit agent and to design a demonstration of the concept. The market for broker-provided paratransit was narrowed to the elderly and handicapped only, as these market segments seemed the most in need of this type of service. The planning effort included determination of the specific services and functions of the broker as well as its internal management structure. Carnegie-Mellon also identified and examined regulatory issues and institutional barriers that could affect implementation of the paratransit broker.

Based on the initial design framework developed by Carnegie-Mellon, the Port Authority of Allegheny County applied to UMTA for a Service and Methods Demonstration grant to test the broker/agent concept in Allegheny County.

*See Richard A. Stafford, An Investigation of the Potential of Paratransit Services for the Pittsburgh Region, Urban Systems Institute, Carnegie-Mellon University, June 1976.

The grant application, submitted in August 1977, was the product of extensive planning activities by the SPRPC and the Port Authority as well as Carnegie-Mellon. These activities are documented in the "Planning Documentation Report: Urban Transportation Planning for Handicapped and Elderly Persons in the Pittsburgh Urbanized Area."* The study documents the incidence of elderly and handicapped persons in the Pittsburgh area, their transportation needs, available transportation options, and possible solutions. The report was partly an outgrowth of a multi-year, continuing effort by the SPRPC and the Port Authority to be responsive to public concerns for transportation for the elderly and handicapped. Public concerns about these services were voiced formally to the SPRPC and the Port Authority through an Advisory Committee composed of elderly and handicapped citizens, transportation providers, social service agencies, and governmental agencies. The Advisory Committee has played a similar role throughout the course of the demonstration.

During the SPRPC and Port Authority's planning efforts, a host of paratransit services were identified as serving elderly and handicapped persons in the Allegheny County area. These services tended to be duplicative in their geographic areas and restrictive with regard to the consumers they served (some would serve only elderly, others only people with particular handicaps, etc.). It was believed that this uncoordinated use of resources tended to result in a higher cost per trip than would be necessary if ridesharing were undertaken. Moreover, the lack of rationalization tended to confuse consumers, leaving some without services for which they were eligible. Therefore, a principal recommendation included in the region's Transportation Improvement Program was to establish coordinated paratransit services for elderly and handicapped persons. This objective had been urged at the Federal (U.S. DOT and Department of Health, Education and Welfare) and at the state (Pennsylvania Department of Transportation and Department of Welfare) government levels.

The Port Authority's grant proposal suggested that an organizational design be implemented in Allegheny County that would give all social service agencies and individual elderly and handicapped consumers the opportunity to buy services on a unified paratransit system at ridesharing rates. The paratransit service would be much simpler to use and, compared to existing paratransit services in the county, would be improved in several other ways, primarily through better management and coordination.

The key element in the proposal was the use of a single organization, an agent/broker, to manage the coordinated services for elderly and handicapped persons. This agent concept was a direct outgrowth of Carnegie-Mellon

*Southwestern Pennsylvania Regional Planning Commission, 1977.

University's planning studies. The broker was to set up and monitor the coordinated paratransit system and refer people to other transportation modes, such as the Port Authority's mass transit system, when they were more appropriate for the individual's needs. The agent/broker, it was planned, was to utilize rather than preempt existing paratransit providers for elderly and handicapped persons. A final significant aspect of the proposal was its emphasis on a design that facilitated user-side subsidies to particular eligible groups rather than a design that demanded the service itself be subsidized. Concurrent with demonstration planning, the Port Authority decided to offer a user-side subsidy for broker services to handicapped persons unable to use regular, fixed-route buses. Able-bodied elderly persons and other handicapped persons would be able to use the services of the broker but would not be subsidized.

1.2.2 Regulatory Issues

Final approval by UMTA of the grant application was delayed because of three concurrent regulatory proceedings. The first of these involved the issue of who has the authority to regulate paratransit in Allegheny County. Historically, the Pennsylvania Public Utilities Commission (PUC) had issued Certificates of Public Convenience for call-on-demand, exclusive-ride taxi service in geographically defined service areas. The certificates were defined to prohibit shared-ride services except in special circumstances (such as inclement weather or unusually heavy traffic) and only when passengers were all picked up at the same origin. In November 1973, as a direct result of the national energy emergency, the PUC temporarily lifted its restrictions on the provision of group services by certified carriers. In 1976, the PUC began accepting applications from certified carriers for special certificates for shared-ride service under a Policy Statement issued by the Commission. These "paratransit certificates" allowed taxi operators to use vans in special operations, including plan-a-ride, share-a-ride, and dial-a-ride services. Four Allegheny County certified taxi operators and one not-for-profit operator were granted special certificates following the PUC's ruling. After these certificates were granted, the Port Authority filed suit in Pennsylvania Commonwealth Court seeking to revoke them. The suit contended that the Port Authority had the sole legal right to regulate and authorize paratransit service in Allegheny County under the "Second Class Port Authority Act."

At the time the demonstration was getting underway, the effect of a ruling against the Port Authority was unknown. A particular concern was that a negative decision would hinder the broker from fostering ride-sharing by elderly and handicapped patrons in both taxis and vans. A court decision in the summer of 1981 affirmed the Port Authority as the sole regulator of paratransit services. Thus, this suit did not ultimately affect the demonstration.

A second regulatory issue involved a legal suit enjoined when the Port Authority issued authorizations to nine social service agencies providing paratransit services under contract to Allegheny County Adult Services/Area Agency on Aging, giving them formal authority to provide shared-ride service for the county. Several Allegheny County taxi operators (Yellow Cab, North Hills Green Cab, Colonial Taxi Cab, Tube City Taxi) filed suit against PAT in Allegheny County Common Pleas Court in March 1978, contending that the Port Authority had no legal right to certify paratransit carriers. The suit asked the court to nullify approvals that had been given and also sought damages.

Again, during the initial stages of demonstration planning, the outcome of this suit was not known. The suit was never vigorously pursued, perhaps because of the concurrent suit brought by the Port Authority. In the short run, the Port Authority authorization to social service agencies became a moot issue for the private taxi companies involved in the demonstration because rides provided by taxi companies to elderly and handicapped persons increased as a result of the demonstration.

The third regulatory issue that delayed final approval of the grant application was related to Section 13(c) of the Urban Mass Transportation Act, which provides protection to mass transit labor when Federal subsidies are used by a local transit operator. The Port Authority reached an agreement with its union in the fall of 1977 concerning job protection under the demonstration project. UMTA asked the Department of Labor (DOL) to grant certification of 13(c) compliance before approving the demonstration grant. Two taxi unions (the Teamsters and Colonial Taxi's union) wrote letters to the Secretary of Labor requesting that they be afforded the same protection as mass transit workers under the terms of 13(c). The DOL, in March 1978, certified the Port Authority's 13(c) agreement with its own union, subject to the Authority's assurance that it would extend the same protection in that agreement to certain taxi employees who could be considered mass transit workers.

Shortly after resolution of the 13(c) issues, UMTA made a legal determination that the pending suits concerning regulatory authority for paratransit services would not necessarily affect demonstration implementation. The UMTA findings stated, "Even if the PUC were found to have exclusive jurisdiction over paratransit service, the project could proceed although the number of competitors for the provision of paratransit service might be limited." The Office of Chief Counsel of UMTA recommended that the demonstration project be implemented in phases, and that UMTA concur before the Port Authority proceeded with the operational phases. The grant application received final approval from UMTA in late July 1978.

1.3 DEMONSTRATION OBJECTIVES

The primary sponsors of the Pittsburgh Paratransit Brokerage Demonstration project were the Port Authority of Allegheny County, which provided local funding for the project, and the Service and Methods Demonstration Program of the U.S. DOT, which provided Federal funding. Both of these organizations established objectives for the demonstration, which we will discuss in this section. These objectives are important because they provide a measuring stick for evaluating the results of the demonstration.

1.3.1 Objectives of the Port Authority for the Demonstration

As discussed above, the Port Authority, with the assistance of the SPRPC, undertook a major planning effort prior to applying to UMTA for a demonstration grant. The impetus for this planning effort, and consequently the demonstration grant application, came from two sources. As noted in the Port Authority's grant application, these sources were the consumers of services for the elderly and handicapped, and governmental mandates for service provision and coordination.* By the late 1970s, the elderly and handicapped communities were sufficiently organized nationally to voice strong support for improvements in transportation services for the disabled. In Allegheny County, concern about elderly and handicapped service led to the formation of an Advisory Committee, which, as explained above, coincided with and supported the development of the paratransit broker concept. One objective of the Port Authority in supporting the paratransit broker, then, was to continue with its multi-year effort to study and improve transportation services for the elderly and handicapped.

The brokerage project can also be seen as a means for the Port Authority to meet several Federal mandates regarding service to the elderly and handicapped. Both the U.S. Department of Transportation and the Department of Health, Education and Welfare recommended the use of coordinated transportation systems in serving these groups as a means of lowering the cost of service provision. The Port Authority intended to use the broker project as a method of "testing the benefits of coordinating public transportation assistance programs" and also of "finding ways to achieve that coordination that can accommodate the various interests involved.**" To this end, an objective of the demonstration was to successfully coordinate existing transportation resources for the purpose of cost savings.

*Port Authority of Allegheny County, "Proposal for Implementation of an Agent/Broker in Allegheny County to Coordinate Paratransit Services for Elderly and Handicapped Persons," submitted to the Urban Mass Transportation Administration, 1977, p. iii.

**Ibid., p. 2.

Furthermore, the Port Authority was confronted with the ultimate challenge of meeting the requirements of Section 504 of the Rehabilitation Act of 1973. In its grant application, the Port Authority states that:

... the demonstration will test the effectiveness of paratransit service as an alternative to the public bus system for delivery of transportation services to those not fully ambulatory. Allegheny County is a particularly good place for such a test because steep topography and limited but favorable experience with present uncoordinated paratransit services have convinced many handicapped persons that paratransit is a preferable alternative.*

Thus, for the Port Authority the broker was seen as a possible alternative to fixed-route accessible buses. The 75 percent discount offered by the Port Authority to those persons unable to use fixed-route service, and the Authority's general support of ACCESS represent the organization's response to its obligation to provide transportation to the handicapped. In its 1980 transition plan for meeting Section 504 requirements, the Port Authority identified this user-side subsidy program as its interim program of service to the handicapped until such time as its fixed-route network was accessible.

1.3.2 Objectives of the Service and Methods Demonstration Program for the Demonstration

The primary objective of all projects sponsored by the Service and Methods Demonstration Program is to test innovative and promising improvements in transportation provision. A key element of these projects is the dissemination of information about the project as an aid to localities considering similar improvements. One way in which this information is provided is through a thorough evaluation of the innovation contained in an evaluation report. These evaluations, which are managed for UMTA by the Transportation Systems Center, typically identify a number of "evaluation issues" that become the focus of the analysis. Often, evaluations involve the collection of data about the demonstration to facilitate an understanding of its effect on various institutions and groups.

The Transportation Systems Center identified a number of issues as the focus of the SMD evaluation of the Pittsburgh Brokerage Demonstration.** These issues have been examined for TSC by Charles River Associates Incorporated, the evaluation contractor for this project.

*Ibid., pp. 2-3.

**Elizabeth Page, "Evaluation Framework for the Pittsburgh Service and Methods Demonstration Project," Transportation Systems Center, Staff Study, December 1978.

The first issue to be investigated concerned the ability of the broker to overcome regulatory and institutional barriers to coordination. As discussed above, several regulatory issues surrounded the implementation of the broker and threatened to delay and/or hinder the achievement of a full-scale coordinated effort. The outcome of these regulatory controversies would have important implications for other attempts at transportation brokerage. The institutional barriers facing the broker were potentially of equal importance to the outcome of the project. The broker would attempt to combine for-profit and not-for-profit carriers into a coordinated network. Because the operating procedures and philosophies of these two organizational types often differ, the broker would have to develop contracting and monitoring methods compatible with both. Another institutional barrier faced by the broker was the diversity of the institutional requirements of those purchasing service. Different legislative and administrative requirements are imposed on various groups sponsoring transportation for the elderly and handicapped. This diversity provided a challenge to the broker in developing procedures that could accommodate the range of institutional needs.

A second objective of the Pittsburgh demonstration evaluation was to examine both the administrative procedures used by the broker and the cost of these functions. Any locality considering the implementation of a transportation broker is concerned about the administrative resources required. Thus, the demonstration was designed to produce information about the administrative costs of a broker. In addition to these costs, the demonstration provides information about three billing mechanisms used by the broker. These mechanisms are third-party billing, used for transactions with human service agencies; full-price scrip, sold to unsubsidized individuals using ACCESS; and reduced-price scrip, sold to individuals subsidized under the Port Authority's user-side subsidy program. The broker's administrative procedures and costs are discussed in Section 3 of this report.

A third objective of the demonstration evaluation was to measure the effectiveness of the broker in improving the quality of paratransit resources in the community. Because the broker would control access to a large portion of the market for paratransit services, it was expected that it could enforce requirements for carriers' service delivery, aimed at improved service quality. For example, the broker could require that all drivers attend a sensitivity training course.

A fourth objective of the evaluation was to examine the effect of the broker on the cost of transportation service. It was anticipated that cost savings could be realized in two ways. First, by aggregating the demand for service, the broker would be able to schedule trips in such a way that a higher level of ridesharing could be achieved than that attained in an uncoordinated system. The second way in which cost savings could be achieved

was through the promotion and encouragement of competition among carriers. Prior to the demonstration, private for-profit carriers served circumscribed service areas, with little head-to-head competition. Agency vehicle fleets, rather than competing with for-profit carriers, served specific trips for agency clients, almost constituting a separate market. To decrease transportation costs, the broker could engender competition, contrary to existing behavior among the for-profit providers and between these carriers and not-for-profit providers. Issues related to the impact of the broker on paratransit supply are discussed in Section 4 of this report.

A fifth objective of the evaluation concerned the response of human service agencies to the broker. Despite the possibility of cost savings resulting from coordination, many agencies chose not to participate in a coordinated system. Some agency managers feared dramatic degradations in service quality and in the agency's ability to control its transportation resources. To ensure that agencies participated in ACCESS, it was imperative that the broker both provide transportation that met the agencies' needs and develop mechanisms for marketing these services. Hence, to understand the role of the broker, it is necessary to understand why some agencies participated in the program while others did not.

Conversely, it is also important to document the effect of agency behavior on the broker. If few agencies participate or many are slow to participate, the broker can face substantial deficits in its transportation accounts. This issue is very important to localities considering the formation of a transportation broker because it influences the level of resources needed to support the broker. The response of agencies to the broker is discussed in Section 5.

A final objective of the Pittsburgh demonstration evaluation was to measure the effect of the project on the mobility of the transportation-handicapped population. This has been a goal of many SMD projects related to the elderly and handicapped. As is true of other demonstrations, the Pittsburgh demonstration provided valuable information about both the characteristics of those who take advantage of specialized transportation services and the extent of their usage. To obtain this information, the Service and Methods Demonstration program sponsored a number of surveys of elderly and handicapped residents of Allegheny County. The largest of these, the Pittsburgh travel diary, provided data on the travel patterns of those who participate in ACCESS, those who are eligible to participate but do not, and the general public. Some of the findings from these surveys are presented in Section 6 of this report.

2. DEMONSTRATION SETTING

The Pittsburgh Paratransit Brokerage Demonstration tests the brokerage concept on a scale unprecedented in previous paratransit brokerage projects. Its scale is distinguished by three important features of Allegheny County -- the size of the potential demand pool, the physical dimensions of the service area, and the number of transportation providers and purchasers to be coordinated by the broker. These dimensions make Allegheny County a challenging location in which to implement and evaluate coordinated paratransit services. This section describes each of these features and their implications for the demonstration.

2.1 ALLEGHENY COUNTY'S ELDERLY AND HANDICAPPED POPULATION

The U.S. Bureau of the Census estimates Allegheny County's 1980 population to be 1,450,085 persons, 423,938 of whom reside in the city of Pittsburgh.* Like many northeastern and midwestern industrial centers, Allegheny County lost population during the 1970s, experiencing a 9.7 percent decrease in residents between 1970 and 1980. As shown in Table 2-1, this population loss resulted in a slight decline in population density.

During the 1970s, Allegheny County also experienced a shift in the age distribution of its population. In 1970, 11 percent of county residents were age 65 or over; in 1980, 13.8 percent of county residents were age 65 or over. A large number of handicapped persons also reside within Allegheny County. A regional planning report, prepared in 1978 by the Southwestern Pennsylvania Regional Planning Commission (SPRPC), estimated that 16.3 percent of the county population is 65 years of age or older and/or handicapped.** This SPRPC information was the only data available to ACCESS planners at the time the program was implemented. Additional information on the incidence of these groups is available in Section 6 of this report, which documents the findings of the Pittsburgh travel diary.

While ACCESS service is available to all elderly and handicapped citizens, only those who cannot board a bus are eligible for the Port Authority of Allegheny County fare subsidy. In Section 6, we estimate that 30,343 persons, or 2.1 percent of the Allegheny County population, are unable

*All 1980 statistics are drawn from U.S. Bureau of the Census, Census of Population and Housing, 1980, Summary Tape File 1A, pp. 128A and 128B, 1981.

**Southwestern Pennsylvania Regional Planning Commission, "Transportation Planning for Handicapped and Elderly Persons in the Southwestern Pennsylvania Region," Draft Planning Documentation Report, Vol. II, November 1978.

TABLE 2-1. CHARACTERISTICS OF ALLEGHENY COUNTY, PENNSYLVANIA

<u>Characteristic</u>	<u>1970</u>	<u>1980</u>
Population	1,605,016	1,450,085
Population Growth Rate (ten-year annual rate in percent)	-1.4	-9.7
Area (square miles)	728	728
Population Density (persons per square mile)	2,205	1,992
Population of Largest City (Pittsburgh)	520,146	423,938
Median Age (years)	32.4	33.7
Age Distribution (percent below age 18)	31.9	23.8
(percent age 65 or above)	11.0	13.8
Average Number of Persons per Household Unit	3.1	2.7
Income Distribution (family income)		
(percent below \$5,000)	12.4	5.5
(percent above \$15,000)	58.5	70.6
(median family income)	\$10,076	\$21,643
Households with One or More Automobiles	76.9	79.3

SOURCES: U.S. Department of Commerce, County and City Data Book, 1972 and 1977; U.S. Bureau of the Census, Census of Population and Housing, 1980, Summary Tape File 1A, pp. 128A and 128B, 1981; calculations by Charles River Associates.

to board a standard bus. The potential number of Port Authority fare subsidy users is thus very large.

SPRPC estimates that the greatest densities of the elderly and handicapped are within the City of Pittsburgh, in the western portion of the south hills and in the south and north sides. Figure 2-1 maps the density of the population aged 55 or over, as determined by the 1970 census. Figure 2-2 shows the 1970 density of nonambulatory persons by municipality. These figures illustrate the wide dispersion of ACCESS' potential market.

2.2 PHYSICAL CHARACTERISTICS OF ALLEGHENY COUNTY

Allegheny County is located in southwest Pennsylvania near the Ohio and West Virginia state borders. The city of Pittsburgh, located at the juncture of the Allegheny and Monongahela rivers (which meet to form the Ohio River) is situated almost in the center of Allegheny County. Pittsburgh, the only city in the area with a population over 100,000, is the most densely populated area of the county.

Much of Allegheny County is still undeveloped, particularly the northeastern part. Of its 728 square miles, residential land use accounts for 22 percent of the total. Other major land uses in the county include forest (12.5 percent) and crop/pasture land (8.7 percent). The three rivers and the minor streams joining them flow through many valleys and are surrounded by high hills and precipitous bluffs. Nearly 300 major bridges and several hundred lesser ones span the valleys within the county. Two sets of twin tunnels carry traffic to southern and western residential areas, while another tunnel makes possible the limited-access Penn Lincoln route to the east.

Because of these topographical features, travel is often difficult in Allegheny County. Many outlying residential areas are separated by great distances, tunnels, and/or bridges from downtown Pittsburgh, which contains the region's major medical facilities and other important activity centers. The numerous tunnels and bridges make walking between downtown and nearby areas an unattractive option. The hilly terrain further complicates the problems of traveling in Allegheny County. Particularly in inclement weather, walking is difficult, often impossible, on certain streets.

Allegheny County has a humid, continental type of climate, modified only slightly by its proximity to the Atlantic Seaboard and the Great Lakes. The average January temperature is 28° (Fahrenheit) and the average July

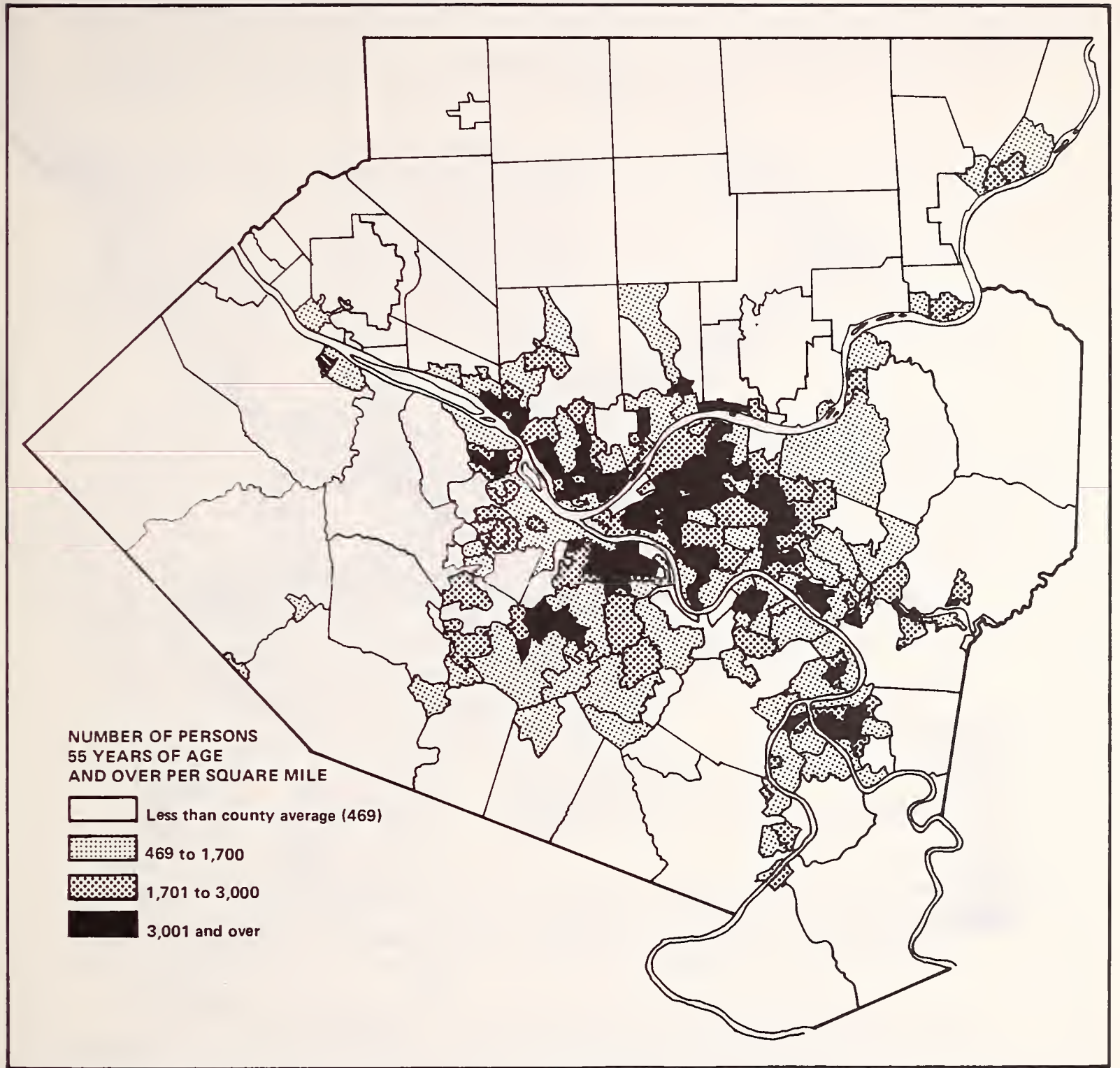

**Figure 2-1. DENSITY OF ELDERLY PERSONS
IN ALLEGHENY COUNTY, 1970
(Persons 55 Years of Age and Older)**

SOURCE: Southwestern Pennsylvania Regional Planning Commission, 1978.

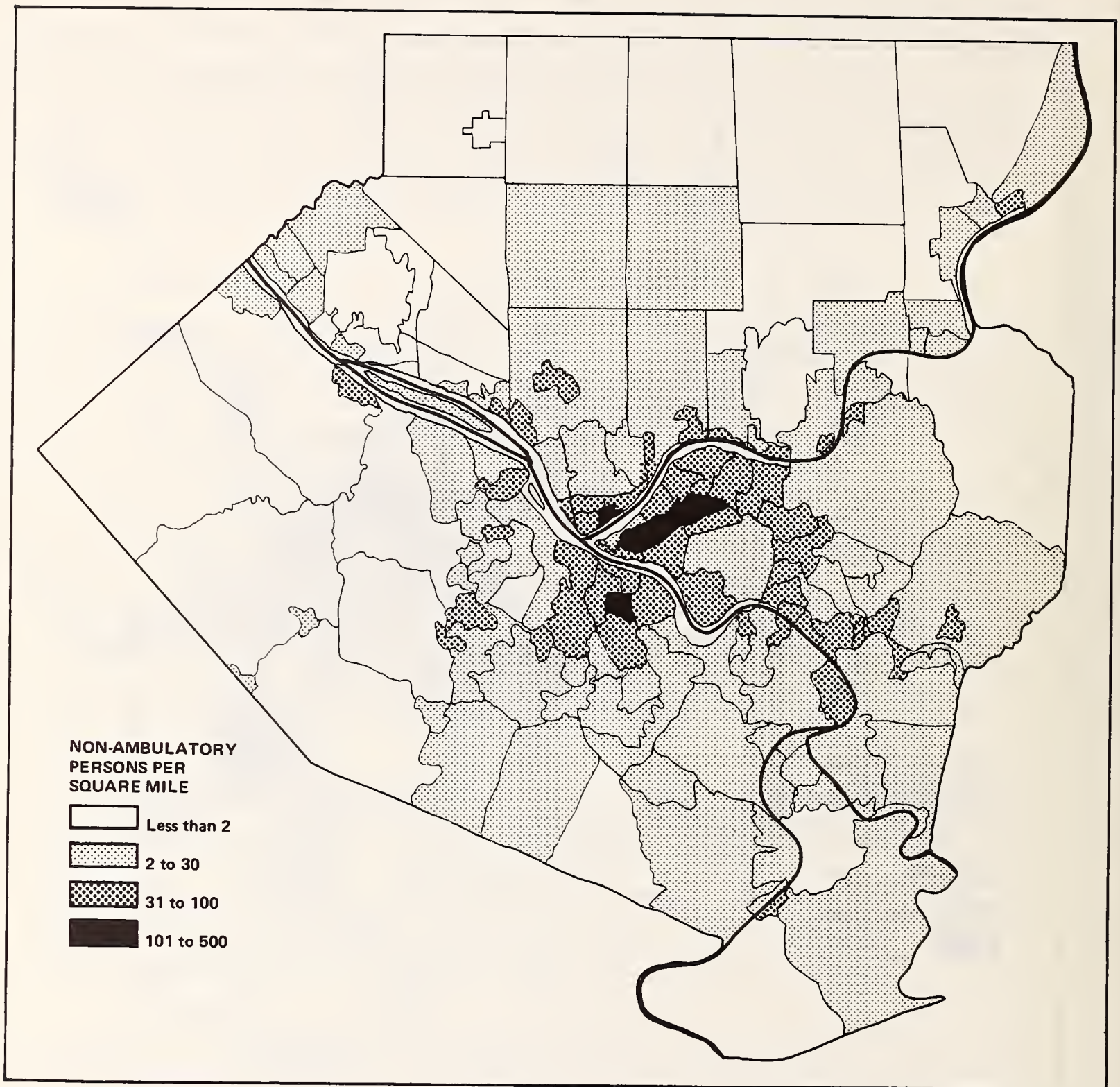

Figure 2-2. DENSITY OF NON-AMBULATORY PERSONS, 1970

SOURCE: Southwestern Pennsylvania Regional Planning Commission, 1978.

temperature is 72°. Precipitation is distributed throughout the year, averaging about 40 inches annually. During the winter months, approximately one-fourth of the precipitation occurs as snow, with the first snowstorm generally occurring in late November and the last in early April. Snow lies on the ground an average of 33 days per year. The winters of 1978-79 and 1981-82 were unusually severe in Allegheny County, with both colder air temperatures and above-normal accumulations of snow.

For Allegheny County's elderly and handicapped citizens, these topographic and climatic conditions make travel extremely difficult unless some type of door-to-door service is available. Because of the hills and poor weather conditions, most members of the county's handicapped community view wheelchair-accessible buses as providing only a partial solution to the transportation problems of the disabled. In all planning efforts undertaken by the Port Authority of Allegheny County or the regional planning agency, door-to-door paratransit has been recommended as a necessary companion to accessible bus service.

Besides making travel difficult, Allegheny County's topographical features have complicated the creation of a unified paratransit network. Historically, paratransit carriers have served only limited geographic areas, delineated, in large part, by Allegheny County's natural barriers of hills and rivers. Therefore, prior to the demonstration, little or no head-to-head competition among carriers took place. Furthermore, large areas of the county were not served by paratransit carriers. In developing an efficient, coordinated network, any transportation broker would seek to promote competition while ensuring that all areas received adequate service. To accomplish this, the broker would have to encourage larger, overlapping service areas, expanding some carriers' territories beyond the natural delineations of Allegheny County's topography.

2.3 PROVIDERS AND PURCHASERS OF TRANSPORTATION FOR THE ELDERLY AND HANDICAPPED

To coordinate transportation resources for the elderly and handicapped of Allegheny County, the paratransit broker, ACCESS, was faced with the difficult task of bringing together numerous providers and purchasers. Both providers and purchasers consisted of disparate groups.

ACCESS was charged with the task of coordinating the gathering of for-profit and not-for-profit providers into a unified delivery network. Prior to the broker's intervention, such cooperation between these two types of providers did not exist. In fact, regulatory action authorizing not-for-profit carriers to provide shared-ride service for passengers other than their clients was vigorously opposed by for-profit carriers.

Before the demonstration began, there were seven for-profit taxi operators authorized to provide paratransit service in Allegheny County. These carriers provided paratransit trips primarily for agencies sponsoring transportation for their clients. Because the greatest portion of transportation funding came from agencies serving mainly ambulatory elderly persons, for-profit taxi companies did not operate many wheelchair-accessible vehicles. In 1977, for-profit taxi companies providing paratransit service operated a total of 710 vehicles with a total seating capacity of 7,496 and a total wheelchair capacity of only 88. Almost 80 percent of the wheelchair capacity was owned by one company, which served only a small portion of the entire county.

At the same time, there were at least 55 human service agencies providing or sponsoring transportation services for their elderly and/or handicapped clients. These agencies provided transportation, either with their own vehicles or through for-profit carriers, as a complement to their other services. Those agencies providing service in their own vehicles often used volunteer or part-time drivers. Unlike their for-profit counterparts, human service providers generally considered service of high quality, rather than efficiency or productivity, to be their prime objective. Many kept only incomplete cost and vehicle records. One agency, Magic Carpet - Open Doors for the Handicapped, offered transportation as its sole operation, subsidized by Allegheny County and City of Pittsburgh contributions. Magic Carpet owned six vans with approximately 21 tie-down positions for wheelchairs and was viewed as an important resource for the handicapped community.

In forming a unified delivery network with these carriers, ACCESS was confronted with the problem of expanding the capacity of for-profit carriers to serve nonambulatory passengers. Part of this task involved sensitizing the carriers and their drivers to the importance of service quality issues when serving the disabled. The broker had also to convince human service agencies of the importance of good record-keeping, efficient scheduling, and productivity in general. It was hoped that gains could be made in these areas without diminishing the agencies' ability to provide high-quality service. Underlying these difficult challenges for the broker was a basic antagonism between for-profit and not-for-profit providers. Fueling this antagonism was the suspicion by for-profit carriers that not-for-profit providers were unfairly subsidized by government assistance programs, in particular Federal 16(b)(2) vehicle grants.

Besides assembling disparate groups of providers, ACCESS was called upon to market its transportation services to a number of different groups. Pre-implementation planning identified human service agencies as ACCESS' largest potential market. The agencies, however, did not represent a cohesive group. Some agencies served the physically handicapped, others served primarily ambulatory elderly persons, and still others served the mentally handicapped. Many of these agencies were concerned about the comfort of their clients sharing rides with persons from different groups. Yet, if it was to provide service at a low cost, ACCESS could place few

restraints on its carriers' ability to organize shared rides. While it seemed unlikely that these three groups would frequently share rides, owing to the different needs of each group (i.e., for vans, taxis, and group service), ACCESS still had to retain the ability to mix passengers in the same vehicle as necessary. Ruling out such mixing would have contravened the basic premise of the project -- to provide transportation for all elderly and handicapped persons.

ACCESS was also planned as a service for handicapped individuals not affiliated with human service agencies. Operationally, it would be difficult for ACCESS to organize shared rides between agency-sponsored and unaffiliated individuals. First, trip requests for each group would be received by carriers at different times. Second, agency trips would be different in nature from those made by unaffiliated individuals. Agencies have historically sponsored trips for a limited number of purposes on a regular basis. Unaffiliated users, however, would use the system for all purposes, with many of their trips being unique. Given these dissimilarities, it would be a challenge for the broker to develop operational systems that could capture any potential cost savings from the coordination of demand by agencies and individuals.

2.4 SUMMARY

Allegheny County is a challenging setting in which to implement and evaluate paratransit brokerage. The county is home to a large number of elderly and handicapped people, requiring the broker to provide transportation service on a large scale. The topographical features of the county, in particular its hilly terrain and severe winters, make specialized transportation the only viable alternative for many handicapped persons. Moreover, the topography presents operational challenges to the broker, in that carriers have traditionally restricted their service areas to districts separated by natural barriers. Finally, prior to the demonstration, transportation services in Allegheny County were provided and purchased by numerous, sometimes opposing, groups. To coordinate transportation resources in Allegheny County, ACCESS had to contend with these dimensions of the demonstration setting.

3. SERVICE DELIVERY AND ADMINISTRATIVE STRUCTURE

This section describes ACCESS service delivery organization, its administrative structure, and the administrative cost of the broker. It is intended to provide the reader with a detailed understanding of how ACCESS works. In later sections, we discuss some of the effects of this service delivery and organizational structure.

3.1 SERVICE DELIVERY

The first phase of the demonstration began shortly after approval of the application with further planning and design activities. (Original planning and concept design were performed by Carnegie-Mellon University and refined by the Port Authority and the SPRPC.) Through a competitive procurement, the Port Authority hired Multisystems, Inc. of Cambridge, Massachusetts, to serve as the broker. Multisystems was chosen from among three bidders and its agreement with the Port Authority is a cost-plus-fixed-fee contract. It became Multisystems' job to turn the concept into a working organization.

Multisystems established a wholly-owned subsidiary, ACCESS Transportation Systems, Inc., with an office in downtown Pittsburgh. One of the first project actions taken was the hiring of a manager for the ACCESS office. The manager soon formed a Task Force to advise him on refinement of the ACCESS system design. This Task Force was drawn largely from the SPRPC Advisory Committee on Elderly and Handicapped Transportation. Foremost among the objectives of the Port Authority, and consequently the new broker, was establishment of a coordinated system that delivered high-quality service. High quality in broker-provided service was deemed more important at this time than other objectives, such as cost savings, for a number of reasons. First, the Port Authority considered high service quality an essential element for maintaining community acceptance and support of the broker. The elderly and handicapped communities supported the Port Authority's efforts to establish the broker, and the Authority, in return, felt an obligation to improve the quality of specialized services available. Second, agencies expressed to the broker their keen desire to receive high service quality. Many agencies that considered purchasing service through ACCESS had had some difficulty dealing directly with taxi companies. Therefore, their use of ACCESS was at least partly dependent on the broker's ability to remove these difficulties for agency staff members and to provide a service that agency clients found acceptable. Third, it should be noted that in its grant from UMTA, the Port Authority received \$482,000, which served as a scrip-risk account. This account, in effect, temporarily shielded local sponsors from the transportation deficits incurred by the broker. This factor certainly played some role in the decision to stress service quality more than cost in the broker's early years of operation.

3.1.1 Contracting for Providers

ACCESS solicits provider services by issuing a request for qualifications (RFQ) annually. Both for-profit and not-for-profit carriers may respond. The RFQ outlines the carrier qualifications necessary for becoming an ACCESS provider. Any carrier that meets these qualifications is eligible to become part of the ACCESS system by submitting a bid to provide service.

The broker takes a number of specific actions to ensure that all qualified carriers consider serving ACCESS trips. As the first step in the process, ACCESS places legal notices in various county newspapers. Next, letters of solicitation are sent to carriers that have expressed an interest in ACCESS service or that have come to the attention of the broker. All interested carriers are then sent a request-for-qualifications form. Carriers already providing ACCESS service must provide an updated qualifications statement. ACCESS does not require that its not-for-profit carriers have Public Utility Commission (PUC) operating certificates, a provision that allows the broker to use human service agencies as carriers. Instead of relying on PUC service requirements, the broker has developed its own service requirements. One of these specifies that, after carriers submit qualifications statements, ACCESS inspects their vehicles for adherence to ACCESS standards.

Soon after carriers submit qualifications statements to ACCESS, for-profit carriers submit a cost bid for providing dedicated service on a vehicle-hour basis. These carriers must also indicate their PUC-authorized metered rate. Not-for-profit carriers submit cost proposals, based on the actual hourly cost of providing service. ACCESS audits not-for-profit carriers as a basis for subsequent contract negotiations. Negotiations with the not-for-profit carriers focus on service quality and improved productivity. Negotiations with for-profit carriers focus on these issues as well as on the level of the bids each carrier makes.

During the first round of carrier contracting in late 1978, 13 providers responded to ACCESS' request for qualifications. Six respondents were for-profit companies, one was a not-for-profit transportation company, one was a public agency, and five were human service agencies. Based on the qualifications presented by carriers in their responses, ACCESS requested that 10 providers submit formal bids to provide service. Two carriers were eliminated because they had little or no experience in providing transportation to elderly and handicapped individuals. Ten contracts were negotiated and signed between carrier representatives and ACCESS management. Two for-profit carriers and one not-for-profit carrier, however, had difficulty obtaining the necessary insurance. The two for-profit carriers resolved their insurance difficulties, only to become involved in a legal dispute not related to ACCESS. The not-for-profit carrier also resolved its insurance problems and began accepting ACCESS service requests. Meanwhile, two other carriers -- one for-profit and one not-for-profit -- decided to

break the terms of their ACCESS contracts by refusing to provide ACCESS service. By July 1979, the ACCESS network had stabilized with six carriers providing service, two for-profit and four not-for-profit.

During the second round of ACCESS contracting in January 1980, one additional carrier began providing service. This was the for-profit provider that had earlier been involved in a legal dispute. These seven carriers renegotiated contracts with ACCESS in 1981, when only one additional carrier submitted a qualifications statement. This carrier, a satellite center for the county MH/MR agency, has a unique relationship with ACCESS. As noted earlier, by 1981 the Port Authority had been legally recognized as having responsibility for regulating shared-ride providers. This MH/MR agency, to be eligible for state Medicaid reimbursements, had to receive operating authority from the Port Authority. Because the carrier mainly provides service to a special needs population, many of whom are also physically handicapped, the Port Authority and the agency decided that the provider should become part of the ACCESS network for regulatory purposes. Under this arrangement, the carrier is subject to ACCESS operating standards but serves only its own agency trips.

In 1982 carrier negotiations, three additional for-profit carriers submitted qualifications to ACCESS. These carriers had previously been approached by the broker, but two had failed to meet ACCESS standards. One carrier had decided not to participate in ACCESS because of its small size. Despite the fact that these carriers had not changed their operations, all three submitted service bids and were accepted into the network. By this time, ACCESS had become less stringent in its application of its original standards, some of which the broker believed reduced competition without offsetting benefits to passengers.

3.1.2 Service Sectors

For the purposes of organizing its service delivery, ACCESS originally divided Allegheny County into 30 sectors, which are shown in Figure 3-1. In ACCESS' first request for carriers' services, providers were asked to indicate which of the 30 sectors they were interested in serving. This service-sector system was designed to prevent conflicts between carriers, particularly between for-profit providers and social service agencies that act as providers. Each carrier was to serve a discrete service area for local trips. Interzonal trips were to be handled by carriers capable of managing large trip volumes. In practice, multiple carrier assignments to certain service areas were necessary to meet the expected volume of trip requests.

An important characteristic of the ACCESS service delivery network is that the service sectors are delineated in practice in a much more fluid manner than Figure 3-1 suggests. That is, the areas served by carriers can change and have changed over time at the discretion of the ACCESS manager.

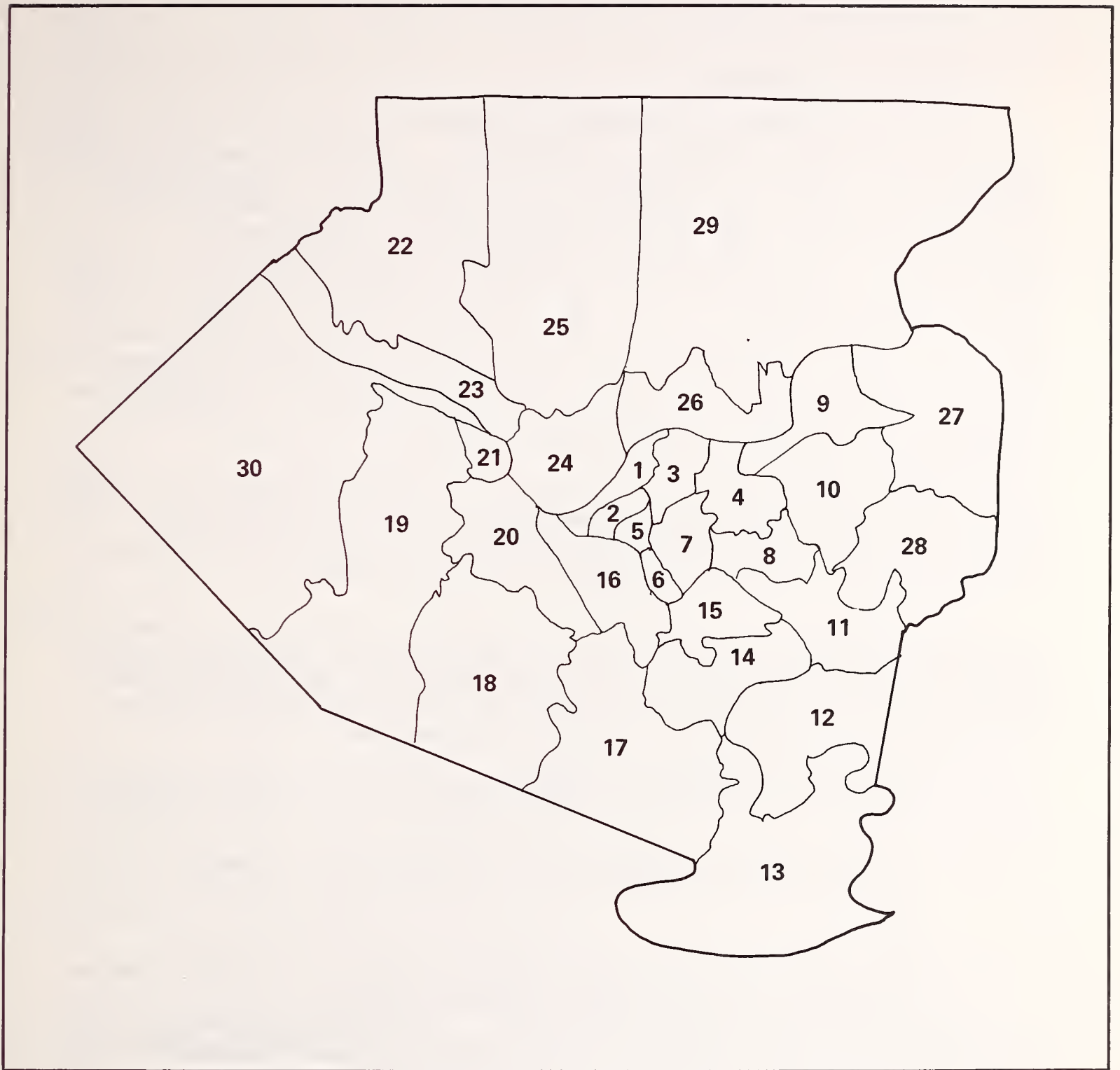

Figure 3-1. SECTOR DIVISIONS USED FOR ACCESS CARRIER BIDDING IN 1979

SOURCE: ACCESS.

As discussed in Section 4, changes in carriers' service areas became more frequent as the demonstration progressed.

3.1.3 Terms of Compensation

Contracts with for-profit carriers differ from those with not-for-profit carriers with respect to terms of compensation. For-profit carriers provide two types of service: "dedicated" and "non-dedicated." Compensation for dedicated service is negotiated on a cost-per-hour basis, including cost of service and a profit margin. Dedicated service is provided with a combination of lift-equipped vans, vans without lifts, and sedans. Essentially, a dedicated vehicle is one that is used exclusively for ACCESS service; ACCESS pays for its use from the time it leaves the garage to the time it returns. ACCESS does not pay for periods during which the vehicle sits idle. Non-dedicated service, mainly taxi service used by the carrier to provide trips that cannot be made on dedicated vehicles, is charged at the PUC-regulated meter rate. Maximum cost escalation factors for fuel price increases are included in most carrier contracts.

Not-for-profit carriers are reimbursed on an actual-cost basis. ACCESS audits of these carriers provide the basis for setting a per-vehicle-service-hour rate. A maximum allowable escalation factor for cost increase is also included in the not-for-profit carrier contracts.

ACCESS permits the simultaneous utilization of any carrier's vehicle for ACCESS and non-ACCESS trips once the written consent of the broker and any agencies involved in cost sharing has been received. ACCESS is charged a pro-rated share of the service cost when such joint utilization occurs. Pro-ration of costs is based on the following factors:

1. Percentage of passenger trips (excluding extra passengers in a group) traveling under ACCESS auspices in a given time period;
2. Percentage of passenger miles (excluding extra passengers in a group) occurring under ACCESS auspices during a given time period; and
3. Any other factor to which ACCESS, the carrier, and other agencies participating in such cost sharing may agree.

It is interesting to note that carriers seldom undertake simultaneous utilization of vehicles for ACCESS and non-ACCESS trips.

3.1.4 Insurance

ACCESS requires that its carriers maintain specific amounts of insurance, and the broker is itself insured against liability claims. Each

ACCESS carrier must take out and maintain public liability and vehicle liability insurance. The amount of this insurance cannot be less than \$500,000 per person and \$500,000 per occurrence, with property damage insurance of at least \$500,000 per occurrence. In lieu of this insurance, a carrier may self-insure against liability claims for the same amounts. In either case, the carrier must indemnify ACCESS, Multisystems, and the Port Authority from all claims for damages and personal injury.

ACCESS has purchased an excess liability policy covering itself and the Port Authority beyond the limits of the carriers' policies. This policy provides for \$5,000,000 in excess liability coverage. A requirement of obtaining this liability coverage was that ACCESS had to impose the insurance standards described above on its carriers.

3.1.5 Vehicle Standards

ACCESS has established rigorous standards for vehicles providing service. All vehicles must have seat belts and all necessary operating equipment. They must also be radio-equipped for communicating with carrier headquarters. While the standard operating features of these vehicles must comply with Federal and state requirements and pass a state inspection, special equipment for serving the handicapped must further pass an ACCESS inspection. The inspection program checklist is included as Appendix A to this report.

While all carriers must submit to vehicle inspection program, not all vehicles in ACCESS service conform to the vehicle standards, particularly with regard to roof height and clearance at the entrance door. Carrier equipment purchased to comply with standards set by other funding sources (e.g., local school boards) has been called into ACCESS service as trip demand has grown. The broker has found it unnecessary to force carriers to make all vehicles comply with more rigorous standards, as few complaints by ACCESS users focus on these equipment features.

3.1.6 Driver Requirements and Training

ACCESS drivers must provide door-to-door service but are not required to help passengers up or down more than four steps. Those passengers requiring additional assistance are requested to ride with an escort, who travels free of charge.

Drivers must also perform a number of administrative duties for ACCESS. They must check the passenger's ACCESS ID card (if the passenger is traveling under the Port Authority subsidy program), collect the appropriate fare (paid in scrip tickets unless the trip is an agency charge), and record complete information on the driver manifest or charge slips. Carrier dispatchers provide drivers with information as to whether or not the trip will be

charged and, if not, the appropriate ACCESS fare. Figure 3-2 illustrates a list of driver responsibilities, as enumerated by ACCESS.

ACCESS requires that carriers send their drivers to a sensitivity training program coordinated by ACCESS staff. All regular ACCESS drivers, particularly those who provide dedicated service, must complete the half-day course. The program places heavy emphasis on understanding the nature of handicapped consumers' disabilities and on sensitivity training. Drivers are "handicapped" with blindfolds, crutches, or wheelchairs, and must negotiate an obstacle course, go out on a downtown street, and board a van. ACCESS drivers are also required to have defensive driver training. An outline of this driver training course can be found in Appendix B.

With regard to its driver training program, ACCESS has found that those drivers with the highest probability of being insensitive are the least likely to participate. Despite ACCESS' requirement that drivers attend training sessions, some do not. Drivers who choose to provide van service tend to be those who have a desire to work with the elderly and handicapped; all of these drivers attend the program. Taxi drivers who infrequently serve ACCESS patrons, however, are less likely to be familiar with or sensitive to the needs of the elderly and handicapped. It is difficult for ACCESS to motivate these drivers to attend the program, because of resistance (they are rarely paid to attend) and because of rapid driver turnover. ACCESS cannot avoid the use of some of these drivers; its service demands are often strongly peaked and carriers find it necessary to respond with any available driver and vehicle.

3.1.7 ACCESS Fare System

The ACCESS fare system is based on 195 geographical zones. A uniform fare is charged for trips with origins and destinations within a single zone. For trips between zones, a fare matrix has been established, with fares based on airline distance between zones and projected costs of providing trips as a function of airline distance. For fare zones that are not easily accessible to one another, an additional charge is added. Maps, a directory of fare zone boundaries, and the matrix of fares for trips between zones are provided to all ACCESS carriers. The map used for this purpose is shown in Figure 3-3. Call-takers are required to quote exact fares to agencies and individuals when they schedule service.

The ACCESS fare from its inception in February 1979 until March 1, 1980 was \$1.00 for each mile of airline distance between the centroids of any two zones, with a minimum fare of \$1.50 (a trip with an origin and destination within a single zone). The minimum charge to people traveling under the auspices of the Port Authority's user-side subsidy program was 38 cents. From March 1, 1980 until October 1982, the fare was \$1.25 for each airline mile with a \$2.00 minimum charge. The minimum charge to a user-side subsidy patron was 50 cents. In October 1982, ACCESS raised its fares significantly,

Driver's Responsibilities

A

ASSISTANCE

- ACCESS is door-to-door service
- Drivers must provide passengers with assistance:
 - entering the vehicle
 - entering their destination
- Drivers need not help passengers up or down more than four steps!!
- Drivers need not go beyond the doorway or entryway of the building.
- Drivers should go out of their way to help with packages
- Drivers must knock on the door and ring the bell if the passenger is not in sight
- Drivers must wait five minutes for their passenger to show up before continuing, but need not wait more than five minutes.

C

COLLECTION OF FARES

- Drivers must collect ACCESS tickets as fare, unless the fare is a charge.
- Drivers should never collect cash as a fare.
- Drivers should check ID cards of passengers
- Drivers should call company to check on fare if uncertain.
- Drivers should call company if passenger does not have enough tickets for fare.
- Drivers should only collect the fare for the trip they have provided — (Do not collect both parts of the round trip fare at the start of the trip).
- Drivers should complete charge slips and manifests carefully — with all necessary information.

C

COMMUNICATION

- When in doubt — call your company.
- Drivers should make themselves familiar with ACCESS service procedure so that they can communicate with passengers about rules, etc. Brochures are available from the ACCESS office.
- Drivers should communicate problems with passengers to company:
 - Passenger safety
 - Inaccessible conditions of home
 - No-shows/cancellations
- ACCESS welcomes suggestions from drivers about the service and procedure.
- ACCESS drivers can receive the monthly newsletter, ACCESS EXPRESS by calling the ACCESS office to place their name on the mailing list.
- ACCESS office number — 562-5353.

E

ESCORTS

- Only one escort may ride free with the ticket-paying passenger
- Escort must be picked up at the same point as the ACCESS rider in order to ride free.
- Additional escorts may be paid for with full-fare, solid blue ACCESS tickets.
- Escorts may ride home after the card-holder has been dropped off, but must pay for the remainder of the ride with full-fare, solid blue ACCESS tickets.
- Two ACCESS card holders may not escort each other.
- In order for an escort to ride free, an ACCESS card holder or an ACCESS passenger paying with full-fare, solid blue ACCESS tickets must be in the vehicle.

S

SAFETY

- Seat belts and wheel-locks must be used at all times.
- Passenger's equipment (wheelchairs) should be in good working order.
- Notify your company about passengers who seem unsafe while traveling. Never tell the passenger that he is unsafe, or that he will no longer be allowed to ride on ACCESS
- Passengers must keep the entryway to their home clear and free of snow and ice

S

SPECIAL PASSENGERS

- Most ACCESS passengers require assistance. They look to their driver for help.
- Extra courtesy and patience is required.
- ACCESS driver training sensitizes drivers to the special needs of passengers. If you have not participated in the driver training program and you are a regular driver, notify your company
- If you have an ACCESS driver training certificate, display it in your vehicle.
- Confusion or unsteadiness is not uncommon among ACCESS riders. Drivers should try to be patient.
- Driver kindness and courtesy encourages riders to continue using ACCESS — helping to insure some level of independence and self-sufficiency for our passengers.

Figure 3-2. ACCESS DRIVER RESPONSIBILITIES

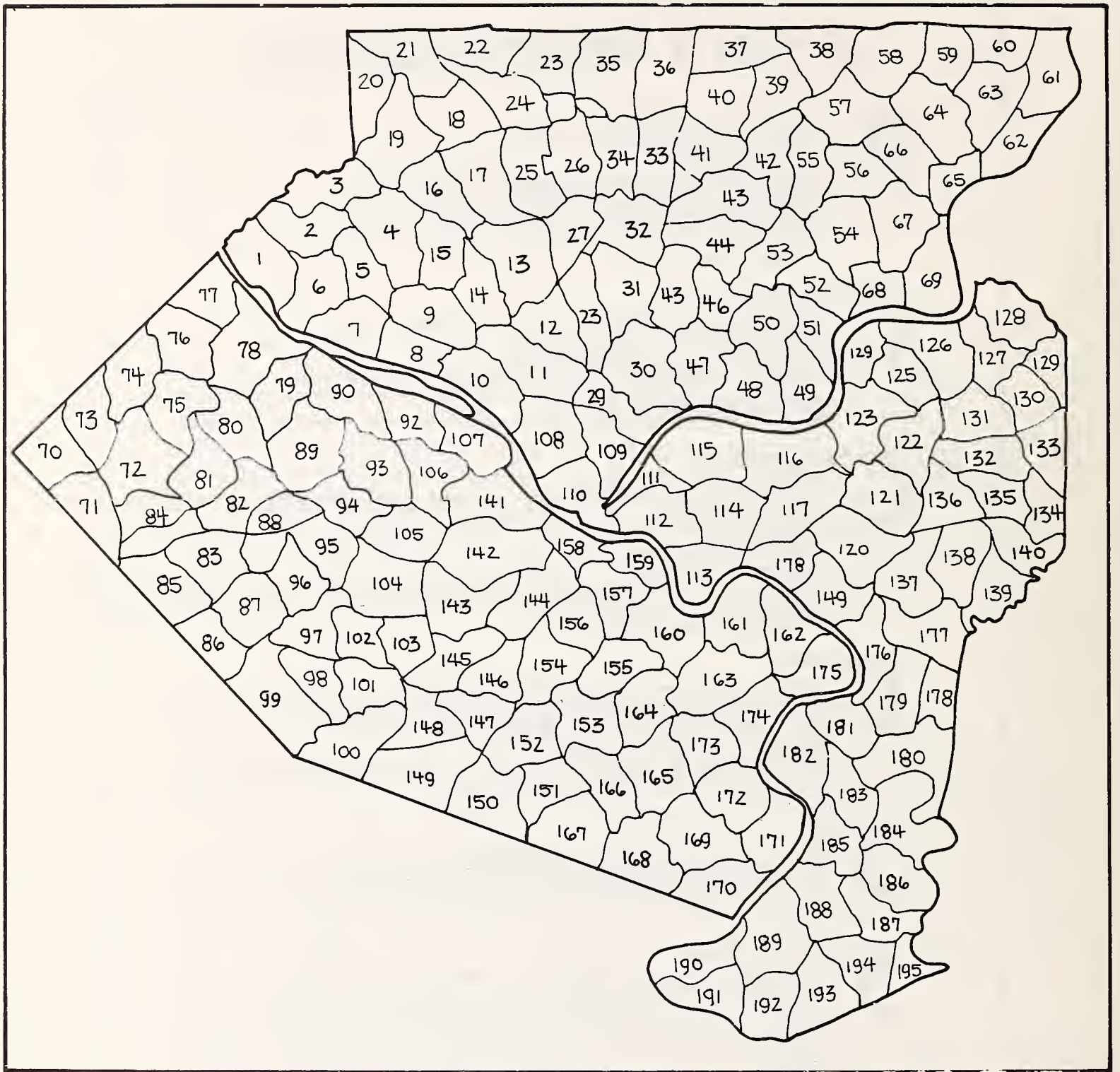

Figure 3-3. ACCESS FARE ZONES

SOURCE: ACCESS.

following a series of public hearings on the subject. The new ACCESS fares are \$3.00 per airline mile, with a \$4.00 minimum fare. These rates are somewhat higher than exclusive-ride taxi service. Partly to offset this fare increase, the Port Authority simultaneously increased its user-side subsidy to persons unable to use fixed-route buses. Previously, the Authority subsidized 75 percent of the cost of service for these ACCESS users. Now it subsidizes 88.75 percent of the cost, with a minimum out-of-pocket cost to user-side subsidy patrons of 90 cents.

Originally, all trips (both agency-sponsored and those made by individual users) were to be priced according to the ACCESS fare system. The fare system was devised as a means to recover close to 100 percent of transportation costs, and it was based on estimated levels of vehicle productivity. Less ridesharing developed than was originally estimated, however, and until 1982, those agencies that paid for service through the fare system often paid less than the cost to ACCESS of service provision. This situation eventually led to the major fare increase in October 1982.

The Adult Services/Area Agency on Aging (AAA), the largest agency purchaser of ACCESS services, refused to purchase service through ACCESS unless they were charged a single per-trip rate. From January 1981 through December 1982, this rate was intended to cover only transportation costs. Since December 1982, the AAA has been charged on a fully allocated cost basis as a result of negotiations between the AAA and ACCESS. AAA charges are estimated directly from carrier trip documentation. Special group trips sponsored by agencies have always been priced on an actual-cost basis.

ACCESS passengers pay for their trips in a number of ways. Agency clients are not required to provide any form of payment. The driver completes an agency charge slip recording the client's name, agency, and origin and destination. Full-price users must pay for their trip with gold-colored ACCESS scrip, which they purchase from the ACCESS office. Users eligible for the Port Authority subsidy pay for ACCESS trips with white-colored scrip, which they also purchase from the ACCESS office but at a discounted price. Both types of scrip are shown in Figure 3-4. Full-fare and subsidized users must show the driver an ACCESS identification card, shown in Figure 3-5, when using scrip.

3.1.8 Scheduling and Dispatching

When originally conceived, the scheduling and dispatching of ACCESS service was to be performed directly by the broker. At that time, it was thought that the savings from higher levels of ridesharing made possible by centralization would outweigh the cost of developing, implementing, and maintaining these functions.

In the initial refinement of the ACCESS design, plans for centralized scheduling and dispatching services were abandoned. The costs of locating

FULL-FARE – GOLD

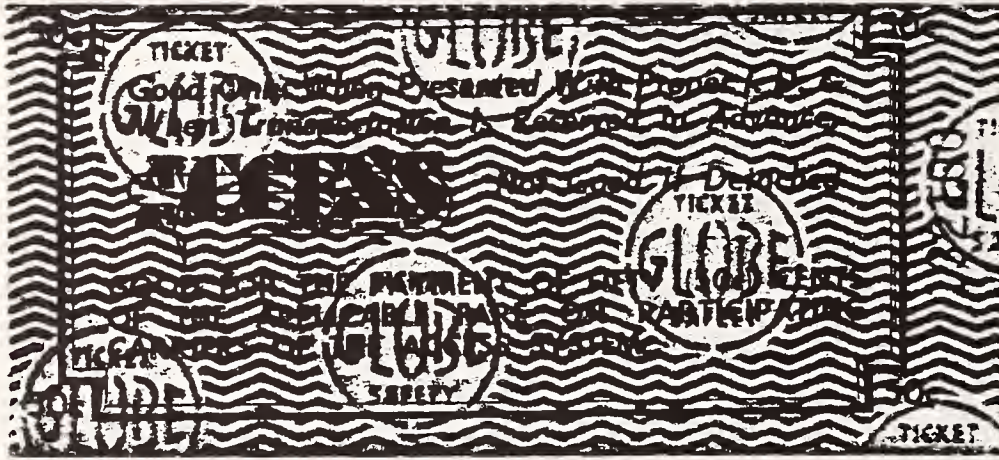

DISCOUNTED – WHITE

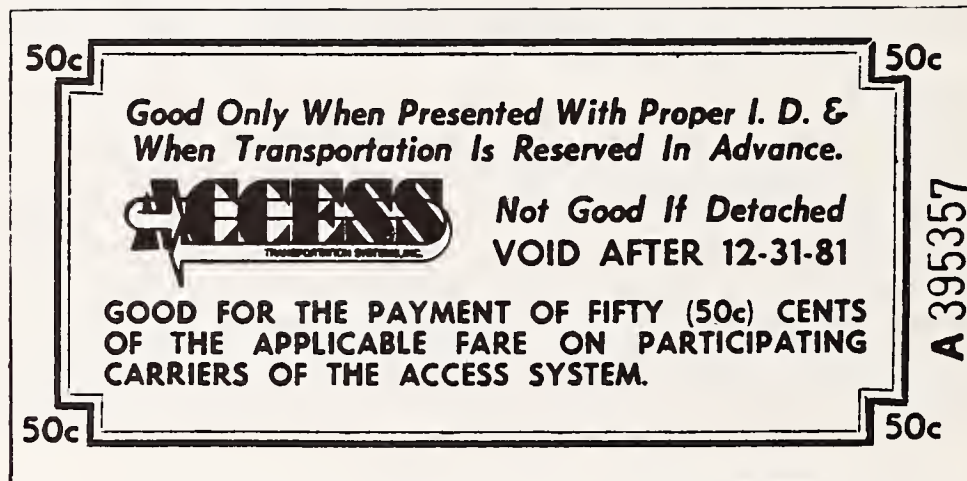

Figure 3-4. ACCESS FULL-FARE AND DISCOUNTED SCRIP TICKETS

FRONT OF CARD



The front of the ACCESS card features a textured background. At the top left, the word "ACCESS" is written in a stylized, bold font. Below it, there are three horizontal lines for "Name", "I.D. No.", and "Exp. Date". To the right of these lines is a large black rectangular area labeled "PHOTO" with a downward arrow. Below the photo area is a small square box. At the bottom center, the text "NOT TRANSFERABLE" is printed.

BACK OF CARD

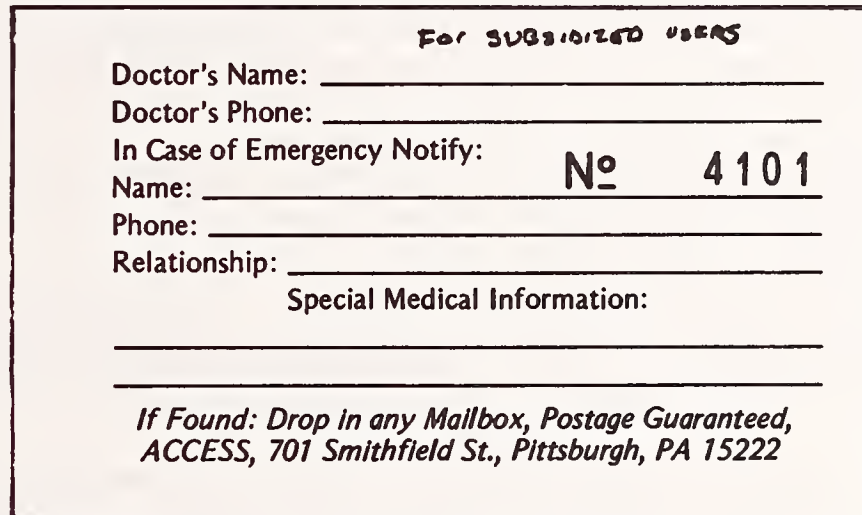

The back of the ACCESS card contains a section titled "For SUBSIDIZED USERS". Below this title are several fields for contact information: "Doctor's Name:", "Doctor's Phone:", "In Case of Emergency Notify:", "Name:", "Phone:", and "Relationship:". The "In Case of Emergency Notify:" field has "No 4101" written in it. Below these fields is a section for "Special Medical Information:" with two horizontal lines for text. At the bottom, there is a block of text: "If Found: Drop in any Mailbox, Postage Guaranteed, ACCESS, 701 Smithfield St., Pittsburgh, PA 15222".

Figure 3-5. BACK AND FRONT OF ACCESS CARD FOR SUBSIDIZED USERS

such functions in the ACCESS office would have been prohibitive and would have constituted a duplication of existing carrier facilities. An alternative plan was developed in which one carrier per service area was to be responsible for only intra-area trips while another, usually a larger taxi company, was to be responsible for inter-area trips as well as a portion of intra-area trips. This system was designed to allow the most efficient possible scheduling of dedicated vans by serving many long-distance trips with taxis.

To some extent, this system is still in effect today. Smaller carriers, particularly the human service agency providers, mainly serve short-distance trips. Long-distance trips, primarily medical trips to downtown Pittsburgh from outlying areas, are relayed to larger carriers that provide service in a taxi, if appropriate for the passenger, or in a van dedicated to ACCESS service. The decision on how the trip will be served is left to the carrier. ACCESS works with the carrier to ensure that the company is scheduling trips in the most efficient manner.

As noted above, scheduling was originally designated the responsibility of the ACCESS office. All service requests were to be made directly to the office. However, as this plan was altered by the decision to rely on carrier scheduling facilities, another method of handling trip requests was devised.

Individuals who are not traveling under the sponsorship of an agency call their ACCESS carrier directly. In its first year of operation, ACCESS produced and distributed brochures that indicated the appropriate carrier to call for service. Since then, patrons have been informed of the appropriate carrier to call when they purchase scrip from the ACCESS office. Individuals who do not know their designated carrier call the ACCESS office directly. The ACCESS office is equipped with a phone system that allows calls to be transferred from ACCESS to each carrier and from one carrier to another. Therefore, calls to the ACCESS office can be and usually are forwarded directly to the appropriate carrier. Carriers that receive calls for service outside their area transfer the call to the appropriate carrier using the same telephone system. Individuals must make ACCESS trip requests 24 hours in advance in order to be guaranteed service.

ACCESS schedules agency trips in one of two ways. The AAA, the largest agency patron of ACCESS, funds 34 satellite centers throughout Allegheny County. These centers handle trip requests for clients within their area. Prior to using ACCESS, the AAA contracted directly with paratransit providers. Under this arrangement, the agency called a special telephone number for each carrier and dealt with the same person daily. Because of the large number of trips involved, most of which were medical trips not made on a regular basis, the carriers accepted the arrangement. When the AAA began to purchase service through ACCESS, this system of direct scheduling with carriers was retained, even though in some cases AAA centers changed carriers as a result of contracting with ACCESS.

All other agencies schedule their trips through the ACCESS office. This arrangement exists for two reasons. First, these agencies schedule only a small number of trips daily, a number not warranting special attention by the carriers. Trip requests could easily be forgotten or misplaced under such a system, a risk the agencies find unacceptable. Second, the agencies do not want to schedule trips with the carriers directly. ACCESS acts as a buffer between the agencies and carriers by fielding agency calls for trip requests. As many of these agency-sponsored trips are regularly scheduled, the ACCESS office is able to handle this function easily. Most scheduling tasks simply involve changes from a regular schedule. This process also serves to strengthen ties between the agencies and broker.

Originally, the ACCESS line was answered 24 hours per day by an ACCESS staff member. After business hours, calls were forwarded to the staffer's home. In the second year of operation, this procedure was replaced with a tape-recorded message from ACCESS providing the telephone numbers of carriers supplying 24-hour service. This revised procedure was instituted after sufficient experience showed that a constant ACCESS staff presence was unnecessary.

3.2 ADMINISTRATIVE STRUCTURE

In performing the functions assigned to it, the broker carries out a number of administrative procedures. This section describes the routine tasks of the broker, including daily and less frequent activities. It also presents an organizational outline of the broker's staff and a breakdown of labor hours by each job category.

The broker performs the following administrative functions as part of its normal operations:

- Carrier solicitation, negotiation, and liaison;
- Agency marketing and liaison;
- Trip scheduling (primarily agency trips);
- Telephone inquiries and referrals;
- Scrip sales and accounting;
- Accounts payable and receivable;
- Complaint management;
- Port Authority user-side subsidy management.

Each of these is described below.

3.2.1 Carrier Solicitation, Negotiation, and Liaison

Carrier negotiations are conducted approximately once a year when new ACCESS contracts are let. The ACCESS manager is responsible for these activities. He formally advertises ACCESS contracting intentions and

prepares solicitation materials. Discussions are held with all existing carriers, during which the manager stresses his goals for ACCESS service and potential improvements for each carrier. Carriers submit qualifications updates and service bids. For-profit carriers also submit cost bids. The ACCESS manager uses these bids to negotiate with each carrier separately, in an effort to obtain cost concessions.

The ACCESS manager pursues a vigorous liaison program with the carriers. Carrier manifests are reviewed by ACCESS staff; their findings are the subject of meetings between carrier representatives and the ACCESS manager. Other liaison activities include planning for service changes, as in the case of Saturday and Sunday service initiation.

3.2.2 Agency Marketing and Liaison

ACCESS markets its service to agency managers. In its first year of operation, ACCESS pursued such marketing activities vigorously. More recently, however, it has engaged in these activities only sporadically, since most agencies are now familiar with ACCESS. Appendix C contains materials that ACCESS sends to agencies who express interest in its service.

Liaison activities with agencies that use ACCESS are ongoing. Agencies, other than AAA agencies, call ACCESS daily to place trip requests for next-day service. At this time, the agencies discuss any concerns or service problems they have. ACCESS maintains a working relationship with the county director of the AAA, and any problems experienced by AAA affiliates are relayed to ACCESS through the AAA director.

3.2.3 Trip Scheduling

All agencies other than AAA affiliates call the ACCESS office Monday through Friday to place their trip requests. As most of these requests are for regularly-scheduled trips, calls are made principally for the purposes of schedule adjustment or trip cancellation.

ACCESS occasionally schedules other trips directly through its office. When three new carriers joined the network in January 1982, their trips were temporarily scheduled through ACCESS. This procedure facilitated the division of trips between these carriers and existing ACCESS carriers. Individuals who were to be served by a new carrier were informed of the change by ACCESS staff and were requested to call the new carrier directly to place additional service requests.

3.2.4 Telephone Inquiries and Referrals

Each day numerous elderly and handicapped citizens of Allegheny County telephone the ACCESS office to obtain information on available services. Often these inquiries are transportation-related, requiring an explanation and description of the ACCESS program. Other inquiries relate to transportation services sponsored by human service agencies. ACCESS has prepared a directory of transportation services available to elderly and handicapped county residents, which it sends to interested persons. In addition, the broker provides information on accessible services available in other cities, as an aid to handicapped persons considering long-distance travel. ACCESS also provides assistance to riders with speech impediments who are unable to schedule trips directly with carriers.

Over time, the number of non-transportation-related calls to the ACCESS office has increased. Elderly and handicapped persons call to request information on housing, medical services, and nutrition programs. Because ACCESS staff are familiar with many of the human service agencies in the county, they refer these callers to the appropriate organization whenever possible.

3.2.5 Scrip Sales and Accounting

ACCESS scrip is sold through the mail and at the ACCESS office. Requests for scrip arrive daily; 90 percent of it is sold by mail. Eligible purchasers must include 10 cents for postage for each book of scrip requested. ACCESS only requests 10 cents because most purchasers buy multiple books and because two books can be mailed for 20 cents postage. Scrip is sold in \$10.00 books only; these contain 20 coupons with a face value of 50 cents per coupon. Returns of unused scrip are accepted provided the coupons remain attached to the book. In 1979, about \$10,000 worth of scrip (face value) was sold each month. In 1980, about \$20,000 of scrip was sold; \$40,000 worth was sold in 1981 and over \$50,000 worth was sold in 1982.

Scrip is sold to discount-eligible people at one-quarter of its face value. The Port Authority reimburses ACCESS for the scrip value not paid by purchasers at the time it is sold. ACCESS' scrip accounts are audited yearly by the Port Authority at the time the Authority conducts its general audit of ACCESS operations.

3.2.6 Accounts Payable and Receivable

A large percentage of the broker's staff time is spent accounting for the purchase and sale of transportation services. Carriers submit invoices to ACCESS for payment of services rendered. Figure 3-6 illustrates an ACCESS carrier invoice. Larger carriers submit their invoices weekly, usually one

ACCESS Carrier Invoice

Carrier: _____ Invoice Period: _____ to _____

Invoice No: _____

1. Calculation of Amount Due Carrier

a. Dedicated Vehicle Hours	_____	
b. Hourly Rate for Dedicated Vehicles	\$ _____	
c. Total Cost of Dedicated Vehicles	\$ _____	\$ _____
d. Total Cost of Non-Dedicated Vehicles		\$ _____
Total Due		\$ _____

2. Performance Data

a. Passenger Trips

Dedicated Vehicles	_____	
Non-Dedicated Vehicles	_____	
Total	_____	_____

b. Vehicle Trips

Dedicated Vehicles	_____	
Non-Dedicated Vehicles	_____	
Total	_____	_____

Figure 3-6. ACCESS CARRIER INVOICE

to two weeks after the service has been provided. Smaller carriers submit invoices less often, sometimes only once per month. Besides an invoice, carriers must submit completed driver manifest records for dedicated service charged to ACCESS. As shown in Figure 3-7, driver manifests provide detailed information about each trip provided in dedicated vehicles. Carriers must submit charge slips for all non-dedicated service. An example of a charge slip is shown in Figure 3-8. Carriers must also submit all scrip tickets collected from non-agency-sponsored patrons.

When cancelled scrip tickets (cancelled tickets are those no longer in books) arrive at the ACCESS office, they are counted and put into bundles of 500. This counting continues throughout the month on a part-time basis. Once the scrip is counted and bundled, it is stored at the ACCESS office until it is audited by the Port Authority. For audit purposes, ACCESS' count of scrip received must equal the value of scrip trips provided in that month. Therefore, ACCESS imposes strict requirements on carriers to return all scrip collected.

ACCESS staff members review carrier records and code trip information. During this process, carrier invoices are reconciled with driver manifest and charge slip records. Staff check to see if the total service hours invoiced by the carrier match drivers' time-in and time-out reports for dedicated vehicles; they also check to see that ACCESS is not charged an unreasonable amount of "dead time" (i.e., time when dedicated vehicles are not in service); and they check for the completeness of records. This last is an important task and it is done on a line-by-line basis. Although they represent a small percentage of trips, some driver manifests or charge slips are invariably missing each month. When this happens, ACCESS staff call the carrier and request the missing data. If the carrier cannot produce the missing records within a reasonable period of time, the company is not paid for that portion of its invoice.

All carrier data are manually coded. The coding of missing trip records is performed after the carrier has forwarded the information. The coded data were keypunched until the summer of 1982, when keypunching was replaced by data entry into a microcomputer. With this microcomputer, ACCESS staff hope to be able to review carrier invoices more quickly and completely. Once the coding and keypunching are finished, the basic monitoring of carrier records can be considered complete. The records are then forwarded to other ACCESS staff who review them for scheduling inefficiencies. All of these procedures are performed almost continually.

The keypunched carrier records are submitted to a computer service bureau, where they are run on a mainframe computer through a program that computes basic tallies and distinguishes missing or unacceptable data. ACCESS staff edit the resulting printouts and fill in missing data. These corrections are then rerun through the tallying program. From this process, agency billing information and operating statistics by carrier (number of passenger trips, cost, revenue, etc.) are produced.

**ACCESS Driver Manifest
Dedicated Vehicle**

PICKUP TIME	Drop Off Time	PATRON		ORIGIN			DESTINATION			No. of Pass.	Wheel Chair User	Escort	PAYMENT		NOTES
				No.	Street	Zone	No.	Street	Zone				Bill. Code	Acct. No.	
1															
2															
3															
4															
5															
6															
7															
8															
9															
10															
11															
12															
13															
14															
15															

Carrier: _____ Date: _____
 Vehicle: # _____ Time: out _____ in _____
 Driver: # _____ Odometer: out _____ in _____
 Driver's signature: _____
 Total ACCESS trips: _____
 Total hours billable to ACCESS: _____
 Total scrip collected: \$ _____

Figure 3-7. ACCESS DRIVER MANIFEST FOR DEDICATED VEHICLES

ACCESS CAB SERVICE CHARGE

Carrier _____

Vehicle # _____

Driver _____ # _____

Date		Pick Up Time	
Fare	B/M	Total	
\$	\$	\$	

Rider _____

Origin Zone	Dest. Zone	No. of Pass.	Escort

Access Fare	Account Number
\$	

From _____

To _____

Please COMPLETE Form. Attach Scrip if Account No. "0"

Figure 3-8. ACCESS CHARGE SLIP FOR NON-DEDICATED VEHICLES

Early in the demonstration, the broker required two months to process carrier records. Gradually, ACCESS staff have grown more proficient at record-processing procedures, and over time carriers have submitted more complete records. ACCESS currently pays carriers within 30 days of invoicing. Because carriers invoice ACCESS about one week after the end of a service period, payment occurs five weeks after the period. This schedule means that, for trips provided at the beginning of a month, carriers do not receive payment for two months after service provision.

ACCESS bills agencies monthly for service provided to their clients. The broker determines how much to bill each agency from the carrier trip records. Most agencies pay for ACCESS service within 45 days of receiving an invoice; a few small accounts have been outstanding for over one year. ACCESS plans to pursue overdue payments more vigorously in the future by withholding service from agencies with longstanding unpaid accounts.

During the demonstration, the broker had little difficulty in meeting the cash flow requirements of paying carriers and billing agencies. At its inception, ACCESS was given a one-time \$100,000 cash advance from the Port Authority as its working capital. This advance allowed ACCESS to pay carriers without necessarily having previously received complete payment from agencies. ACCESS was able to repay the cash advance to the Port Authority in early 1982. By that time, the broker had acquired a new source of working capital -- scrip sales. ACCESS invoices the Port Authority monthly for its subsidy on scrip sold. Because scrip purchasers do not use their scrip immediately, outstanding scrip provides working capital for ACCESS. In 1982, the broker had approximately \$150,000 of scrip outstanding at any given time, providing a more than sufficient source of capital.

3.2.7 Complaint Management

Patrons are encouraged to call or write the ACCESS office when they have complaints about service. Written complaints are forwarded to carriers, and the name of the passenger is kept confidential whenever possible. Those complaints phoned in are recorded by ACCESS staff on complaint forms and are investigated. All serious complaints are followed up by a written response to the patron within ten working days from receipt of the complaint. A phone log is kept of all minor complaints that require no resolution.

ACCESS' assistant manager keeps track of all complaints. She has noted that very few complaints come from agency-sponsored patrons. These riders may be lodging complaints directly with their agencies, when warranted, instead of using ACCESS' complaint procedures. Another reason for the paucity of complaints from agency clients may be that these clients do not realize that ACCESS is providing service. Carriers do not specially mark their vehicles when used for ACCESS.

In general, the ACCESS assistant manager feels that riders have over time modified their expectations regarding ACCESS service. Complaints about late vehicles in 1981 usually involved tardiness of more than one and one-half hours. In 1980, patrons complained regularly about vehicles over 45 minutes late. (ACCESS service is provided within a 20-minute "window" on either side of the requested pick-up time.) Furthermore, riders no longer seem to expect drivers to act as personal escorts. The number of complaints about drivers refusing to provide extra assistance diminished in 1981, indicating a change in patrons' perceptions of the driver's role.

3.2.8 Port Authority User-Side Subsidy Management

The Port Authority offers a user-side subsidy on ACCESS service to individuals not physically able to use fixed-route transit. As first designed, the ACCESS zonal fare schedule was set so as to recover close to 100 percent of ACCESS transportation costs. The Port Authority designed its subsidy program as a discount on this fare schedule. The Port Authority originally decided to offer a 75 percent subsidy to its user-side subsidy patrons only because a 75 percent discount was needed to produce an average user cost that could be considered "comparable" to fixed-route transit. That is, the Port Authority worked backward from the amount it wanted users to pay, on average, to reach an appropriate subsidy amount. A "comparable" fare was defined by the SPRPC Advisory Committee on Elderly and Handicapped Transportation. Discussions among the committee representatives centered on \$1.00 as the appropriate or "comparable" fee for door-to-door service. This amount was twice the bus fare on the Port Authority Transit (PAT) system at that time (1979).

Besides selling scrip, ACCESS manages other aspects of the subsidy program for the Port Authority. It handles many requests for information about the program, and guidelines for subsidy eligibility, shown in Figure 3-9, are sent to all those who express interest. The broker also distributes these guidelines to human service agencies, often in the context of a special presentation by ACCESS staff to agency clients.

ACCESS oversees the certification of individuals who are eligible for the program and processes all records related to an individual's eligibility. The broker subcontracts with the Easter Seals Society for determining who is eligible for the subsidy. Certification sessions are usually held two or more times monthly. Each subsidy candidate must complete an application for the program. Only those who are physically unable to climb onto a bus are certified for the program. Those who experience difficulty in getting to a bus but who can board a bus are not eligible.

Those persons who are certified for the program are photographed by Easter Seals Society staff and are presented with a photo identification card, as shown in Figure 3-5. This card must be shown to the driver each time a trip is taken with the Port Authority subsidy. Whenever a

How to Apply for the **PAT** Sponsored **75% Discount** on **Fares**

1. The only criteria for the 75% discount is whether or not an individual is able to walk up and down the steps of a Port Authority vehicle. The applicant must be unable to board a PAT vehicle independently.
2. All applicants for the discount must appear in person at the Easter Seal Society, 110 Seventh Street, Downtown Pittsburgh.
3. All applicants must make an appointment for certification by calling ACCESS at 562-5353. There are several specified dates each month.
4. All determinations as to an individual's ability to walk up and down the steps of a PAT vehicle are made by an independent therapist at the Easter Seal Society. There is a set of steps from a PAT bus at the site, which applicants are asked to attempt. The physical therapist has the final word as to the applicant's certification.
5. You must provide your own transportation to the certification appointment. If you need help in arranging transportation, call the ACCESS office : 562-5353.
6. If you are determined eligible for the discount, an ACCESS photo ID card will be issued to you on the spot.
7. If you are determined ineligible for the discount, you may still be able to use ACCESS at the full fare. Call the ACCESS office (562-5353) for information.
8. After you have been certified and have received your ACCESS photo ID card, you may purchase \$10.00 worth of ACCESS ride tickets for \$2.50.
9. ACCESS ride tickets may be purchased at the ACCESS office: 701 Smithfield Street, Suite 301, Pittsburgh, PA 15222.

Figure 3-9. ACCESS PROMOTIONAL MATERIAL EXPLAINING SUBSIDY ELIGIBILITY

certification session is held, ACCESS staff are present to describe the system and how it is used, and to sell ACCESS scrip to newly-certified patrons.

ACCESS staff report that the use of the Easter Seals Society for determining subsidy eligibility has been an important factor in the program. The eligibility criteria established by the Port Authority are very stringent, especially compared to those in effect for other user-side subsidy programs nationally. Rather than open the program to all those who experience difficulty traveling, as some programs do, the Port Authority decided to limit the program to those who absolutely could not use fixed-route buses. By doing so, the Port Authority targeted its funding to a narrowly-defined group of people, offering them unlimited use of the ACCESS system, but also potentially generating resentment or feelings of neglect on the part of other segments of the handicapped community. ACCESS staff believe that the use of a third party, which is viewed as an advocate for the handicapped community, added significant credibility to the certification process and was the reason that ACCESS received few complaints concerning the results of certification activities.

3.3 ADMINISTRATIVE ORGANIZATION AND COSTS

ACCESS maintains a contractual relationship with the Port Authority in the form of a cost-plus-fixed-fee contract. As a result, ACCESS employees are not directly hired by the Port Authority. Rather, they are hired and paid by ACCESS Transportation Systems. ACCESS invoices the Port Authority for labor, overhead expenses, direct costs associated with broker operations, and a fixed fee. In the following sections, we describe the ACCESS staff and the average monthly cost to the Port Authority for this staff and its operations. We also provide information on the total costs of the demonstration project.

3.3.1 ACCESS Staff

In 1982, the ACCESS staff consisted of six full-time and two part-time employees. The ACCESS Manager has administrative and programmatic responsibility for all ACCESS activities. He is the main liaison with the Port Authority, with which ACCESS has a contractual relationship. The ACCESS manager negotiates carrier contracts, maintains relationships with agencies that purchase service from the broker, and plans service changes. The manager also attends public meetings related to transportation for the elderly and handicapped, some of which are sponsored by the Port Authority and others by the Southwestern Pennsylvania Regional Planning Commission.

Early in the demonstration, ACCESS' Assistant Manager spent a large part of her time managing promotional and public relations activities. More recently, she has focused much of her attention on review of ACCESS carrier

records, seeking possible scheduling improvements. As before, she edits an ACCESS newsletter (called the ACCESS EXPRESS), makes public presentations about the broker, attends user-side subsidy program certification sessions, and oversees ACCESS' rider complaint procedures.

The Record Reviewer and Coder is in charge of reviewing and coding carrier records. As part of her job, she calls carriers to request information missing from their records. She delegates some of the coding work to other ACCESS staffers and is responsible for its completion.

The ACCESS Bookkeeper processes the keypunched carrier records and is responsible for carrier payment. She prepares monthly operating statistics by carrier including the number of trips sponsored by each agency affiliated with ACCESS. She also invoices agencies for their trip purchases.

ACCESS employs two Receptionist/Clerks who answer the many telephone requests that come into the ACCESS office daily. One clerk is also responsible for scheduling agency trips, responding to patrons' complaints, and arranging certification appointments. The other clerk picks up and opens the daily mail, sells scrip by mail and in the office, and verifies the ACCESS registration of all persons requesting scrip.

Two part-time employees round out the ACCESS staff. Secretarial tasks are performed by a Clerk/Secretary. She also helps to fill scrip orders requested by mail and keeps a ledger of all cash inflows and outflows. In addition to these tasks, she helps code carrier records. A second part-time employee performs keypunching and data entry. This Keypunch Operator also helps code carrier records.

Two other persons are affiliated with ACCESS on a part-time professional basis. The broker employs a person to oversee ACCESS' vehicle inspection program, and a physical therapist, hired under the broker's contract with Easter Seals, to perform certification testing.

3.3.2 Broker Administrative Costs

The broker divides operating expenditures into two accounts -- management costs and transportation costs. Transportation costs, which are discussed in Section 4, are payments to carriers for service provision. Management costs are expenditures for the maintenance and administrative activities of the ACCESS office.

ACCESS' largest management outlay occurred during the period of operations when the office was originally established. In general, variations in management expenses have not corresponded to variations in transportation costs. Over time, the broker has handled an ever-increasing number of trips with little corresponding increase in management expenses. Consequently, the management cost per trip has steadily declined during the

three years of operation. Management costs averaged \$3.71 per trip during the period July 1979 through June 1980. This high per-trip cost was due to low ACCESS usage and heavy front-end expenditures. In fiscal year 1981, management costs averaged \$1.84 per trip, declining to \$1.51 per trip in 1982.

Table 3-1 lists average monthly administrative costs, average monthly transportation costs, and administrative costs as a percentage of total costs. ACCESS' administrative costs, as a percentage of total costs, were 29.5 percent in fiscal year 1980, 17.1 percent in fiscal year 1981, and 14.6 percent in fiscal year 1982.* These costs include the administrative costs of the broker, including administration of the Port Authority's user-side subsidy program.

3.4 COST OF THE BROKER AND USER-SIDE SUBSIDY PROGRAM TO THE PORT AUTHORITY

During the demonstration, the Port Authority incurred expenses from three sources: 1) its user-side subsidy reimbursements; 2) broker administrative expenses; and 3) deficits in the broker's transportation account. A large portion of these costs was offset by the UMTA demonstration grant.

Table 3-2 lists broker expenses, revenues, and user-side subsidy program reimbursements by fiscal period. Broker expenses include transportation and administrative costs. Broker revenues, as presented here, include the value of redeemed scrip paid by subsidized users, the value of redeemed scrip paid by unsubsidized users, and agency payments for transportation provision. This method of accounting understates the actual revenues received by ACCESS because it is based on redeemed scrip values and not on the value of total scrip outstanding. (ACCESS receives payment for scrip both from users and the Port Authority at the time of sale, not when transportation costs are incurred.) This method of accounting conforms to ACCESS' accounting practices.

The value of the Port Authority's portion of scrip redeemed by subsidized users is also shown in Table 3-2. The cost to the Port Authority of these subsidies grew from \$121,372 in 1980 to \$381,529 in 1982 (these figures do not include the cost to the Port Authority of managing the subsidy program). Again, the actual cost to the Port Authority was somewhat higher because it reimburses ACCESS at the point of sale, not of redemption.

*These fiscal years run from July 1 to June 30.

TABLE 3-1. MONTHLY ACCESS COSTS FOR FISCAL PERIODS, 1980-1982

<u>Fiscal Period</u>	<u>Average Monthly Administrative Costs</u>	<u>Average Monthly Transportation Costs</u>	<u>Percent Administrative Costs of Total Costs*</u>
July 1, 1979- June 30, 1980	\$ 23,535	\$ 56,269	29.5
July 1, 1980- June 30, 1981	\$ 26,502	\$128,225	17.1
July 1, 1981- June 30, 1982	\$ 27,550	\$161,053	14.6

*Total costs are administrative and transportation costs combined.

SOURCE: ACCESS Operations Reports, Nos. 28 and 40; calculations by Charles River Associates.

TABLE 3-2. BROKER EXPENSES, REVENUES, AND USER-SIDE SUBSIDY REIMBURSEMENTS

	Fiscal Period*		
	<u>1980</u>	<u>1981</u>	<u>1982</u>
Broker Expenses			
Transportation Costs	\$ 675,227	\$1,538,704	\$1,932,634
Administration Costs	282,417	318,018	330,595
Total Expenses	957,644	1,856,722	2,263,229
Broker Revenues			
Redeemed Subsidized Scrip**	40,458	86,251	127,177
Redeemed Unsubsidized Scrip	15,467	19,219	55,249
Agency Contracts	156,808	567,357	562,859
Port Authority Subsidy Reimbursement***	121,372	258,753	381,529
Total Revenues	334,105	931,580	1,126,814
Net Deficit Before SMD Grant and Additional Port Authority Funding†	623,539	925,142	1,136,415

*Fiscal periods run from July 1 to June 30.

**Includes only the portion paid by users.

***Portion of redeemed subsidized scrip paid by the Port Authority.

†Obtained by subtracting broker revenues and Port Authority Subsidy reimbursement from broker expenses.

SOURCES: ACCESS Operations Reports Nos. 28 and 40; calculations by Charles River Associates.

The final line in Table 3-2 lists the net deficit incurred by broker operations after the Port Authority's contribution for user-side subsidies but before the UMTA demonstration grant. This "deficit" was \$623,539 in fiscal year 1980, \$925,142 in 1981, and \$1,136,415 in 1982. Of this deficit total of \$2,685,096, \$1,797,000 was available from the UMTA demonstration grant, as will be discussed below. The contribution of the Port Authority beyond its user-side subsidy reimbursements, therefore, totaled \$888,096 over the three-year period.

3.5 DEMONSTRATION GRANT EXPENDITURES

An Urban Mass Transportation Administration (UMTA) Service and Methods Demonstration grant provided funding for the broker during its first three years of operation. The total UMTA grant, provided to the Port Authority in phases, was \$2,288,000. Table 3-3 provides a breakdown of expenditures funded by the demonstration grant.

Almost 80 percent of the grant fund, \$1,797,000, was used directly for broker operations. This amount includes \$1,315,000 disbursed under the Port Authority's contract with ACCESS and \$482,000 used as a scrip risk account. This account, established as part of the demonstration, was a fund used by the Port Authority to cover shortfalls between ACCESS' transportation costs and revenue. When the fund was depleted, the Port Authority provided shortfall funding, as discussed above.

Remaining funds were used by the Port Authority for administering the ACCESS program. The Port Authority had responsibility for overseeing implementation of the project and for monitoring ACCESS' progress in meeting the terms of its contract. In addition, the Port Authority undertook several extensive data collection activities related to demonstration evaluation.

TABLE 3-3. BREAKDOWN OF ACCESS
DEMONSTRATION PROJECT FUNDS

Port Authority Direct Labor	\$ 178,000
Port Authority Overhead (40 percent)	75,000
Port Authority Travel	10,500
Port Authority Audit Contract	12,000
Other Projects*	215,500
Scrip Risk Account	482,000
Access Contract	<u>1,315,000</u>
Total	\$2,288,000

*Includes data collection activities associated with the demonstration evaluation; office furniture and equipment; and supplies, postage and printing.

SOURCES: Port Authority of Allegheny County, 1982; and Charles River Associates, 1982.

4. IMPACT OF THE DEMONSTRATION ON PARATRANSIT SUPPLY

Important objectives of the Pittsburgh Brokerage Demonstration were to improve the level and quality of paratransit services and to stimulate productivity as a means of lowering costs. This section examines the changes that have taken place in the supply of paratransit services in Allegheny County as a result of the demonstration. First, the nature of paratransit supply in Allegheny County prior to the demonstration is characterized. Next, we review the features of the broker and assess its possible influences on paratransit supply. Third, we explore the influence of the broker on the paratransit industry, including the promotion of competition among carriers and the coordination of for-profit and not-for-profit providers. Finally, we evaluate the influence of the broker on vehicle productivity, service quality, and transportation costs.

4.1 PRE-IMPLEMENTATION TRANSPORTATION SYSTEM CHARACTERISTICS

Prior to implementation of the brokerage demonstration, there were three different types of transportation providers serving Allegheny County's elderly and handicapped. The activities of these providers -- the Port Authority of Allegheny County, private for-profit carriers, and human service agencies -- are described below. While each of these providers served many individuals before the demonstration, there were both severe gaps and duplication in the delivery of transportation to the transportation handicapped.

4.1.1 Port Authority of Allegheny County

The Port Authority of Allegheny County is responsible for the operation of the public mass transportation system, one of the most extensive in the country. Port Authority Transit (PAT) serves all of Allegheny County and parts of four neighboring counties, covering an area of nearly 800 square miles with a service population of 1.92 million people. The PAT system provides commuter express bus service, Park-n-Ride routes, express trolley service, Shopper's Specials to Pittsburgh's downtown area, and shuttles for sports events, as well as regular route bus, trolley, train, and incline service. The fare system is based on zones; in 1979 the central zone adult fare was \$0.50, with an additional fare of \$0.10 to \$0.15 charged for each zone entered beyond the central area.*

*During the demonstration, the PAT base fare was raised several times, as follows: March 1980 - \$0.60; November 1980 - \$0.75; October 1982 - \$1.00.

The Port Authority has been actively involved in planning transportation services for the elderly and handicapped since 1973, when an Elderly and Handicapped Service Coordinator was appointed. In that year, the Port Authority replaced its reduced-fare program with a free-fare program for the elderly, financed by the Commonwealth of Pennsylvania's state lottery proceeds.

Following the Port Authority's involvement in special planning efforts of the Southwestern Pennsylvania Regional Planning Commission, the Authority began in 1977 to further improve the public transit system for disabled riders. A program for modifying Port Authority equipment in order to facilitate use by handicapped and elderly persons was initiated. All buses purchased after 1977 met Federal accessibility requirements for lowered step heights, and improved signage and lighting, and they provided other features for the semi-ambulatory. PAT also undertook three programs to support the use of these buses. First, many new or modified buses were assigned to routes with high concentrations of elderly and handicapped persons residing in the service area. Second, PAT's Office of Elderly and Handicapped Services established a training program to sensitize bus drivers to the specific difficulties of disabled riders. Third, the Office of Elderly and Handicapped Services sponsored a program to educate the elderly in the proper use of the transit system and those vehicles designed for their needs.

Despite its efforts, much of the Port Authority's service remains inaccessible to the county's elderly and handicapped. Many of PAT's buses do not have handrails or adequate lighting in the stepwells. None are accessible to persons who cannot use steps. Furthermore, given the hilly Allegheny County terrain, many disabled people cannot reach PAT bus stops, even if they are able to use non-lift-equipped vehicles. Thus, PAT service is not a feasible transportation option for the severely transportation-handicapped.

Recognizing this problem, PAT actively pursued implementation of the brokerage demonstration project. Prior to its implementation, however, nonambulatory county residents had three options for transportation service other than those provided by the Port Authority or by family and friends. These "paratransit" providers were either 1) PUC-authorized, for-profit carriers; 2) not-for-profit agencies offering transportation as one of their social services; or 3) a PUC-authorized, not-for-profit carrier located in Pittsburgh. We describe these services below.

4.1.2 PUC-Authorized, For-Profit Carriers

In 1977, seven private, for-profit taxi operators held PUC authorization to provide paratransit services in Allegheny County. Table 4-1 gives information concerning these carriers. They operated a total of 710 vehicles in 1977, with a total seating capacity of 7,496 and a total wheelchair capacity of 88. No data are available for the total number of trips provided

TABLE 4-1. CHARACTERISTICS OF FOR-PROFIT CARRIERS INVOLVED
IN PARATRANSIT FOR THE ELDERLY AND HANDICAPPED, 1977

Carrier	Number of Vehicles			Total Seating Capacity	Total Wheelchair-Accessible Vehicles	Total Wheelchair Capacity	One-Way Passenger Trips per Month*	Average Cost Per Passenger Trip*
	Bus	Van	Taxicab					
Colonial	7	37	77	1,424	21	76	5,800	\$2.65
Yellow Cab	0	35	400	3,220	3	9	2,600	\$2.49
Tube City	0	2	24	198	1	3	700	\$5.82
North Hills	28	35	5	2,228	0	0	N.A.	N.A.
People's Cab	0	2	20	140	0	0	N.A.	N.A.
Tri-Borough	0	2	8	104	0	0	N.A.	N.A.
Diamond Cab	0	0	26	182	0	0	N.A.	N.A.
TOTAL	35	113	560	7,496	24	88	N.A.	N.A.

*These figures report ridership and cost per trip only of services under contract to the Area Agency on Aging. As explained in Section 5.3, records of passenger trip totals are not accurate and the true average cost per passenger trip was probably higher.

N.A. = Not Available.

SOURCE: Southwestern Pennsylvania Regional Planning Commission, "Transportation Planning for Handicapped and Elderly Persons in the Southwestern Pennsylvania Region," Draft Planning Documentation Report, Vol. II, November 1978.

to elderly and handicapped persons by these carriers. Their 1977 service areas are shown in Figure 4-1.

As is evident from Figure 4-1, prior to the demonstration, for-profit carriers served overlapping geographic areas while many areas received no service at all. Overlapping service areas were present in the city of Pittsburgh and its southeastern environs. This pattern reflects the higher density of demand for taxi services in these areas. It also reflects the decision of the Public Utilities Commission (PUC) to allow multiple carriers in some locations. As noted in Section 1, the PUC regulates the taxi industry, and in 1977 the commission issued operating certificates to more than one carrier in a given market when it could be determined that there was sufficient demand in the area to support multiple carriers.

4.1.3 Not-For-Profit Human Service Agency Carriers

The major agency funding source for paratransit services in Allegheny County is the Allegheny County Adult Services/Area Agency on Aging (AAA). The AAA is a central source for receipt and distribution of Federal and state funds for the elderly. The AAA provides funding to both publicly and privately operated not-for-profit outreach centers throughout the county. These centers provide transportation service in their own vehicles and/or purchase service from private carriers. In 1977, transportation was provided directly by 12 of the outreach centers, the costs of which were reimbursed by the AAA. An additional six centers used AAA-subcontracted taxi service. Figure 4-2 illustrates the AAA transportation network in 1977. Including both purchased service and service provided by centers directly, the AAA accounted for approximately 70 percent of county-wide, agency-sponsored trips in 1977.

A second major funding source for paratransit is the Allegheny County Mental Health/Mental Retardation/Drug and Alcohol Program (MH/MR). MH/MR contracts with private not-for-profit organizations, which in 1977 operated 11 Catchment Area Centers around the county. In addition, MH/MR has ties with 30 county-wide multipurpose social agencies. In 1977, MH/MR operated its transportation services in much the same manner as the AAA. MH/MR-funded trips were provided with county-owned vehicles (vans and station wagons), with back-up and extra service purchased from for-profit taxi operators. Figure 4-3 illustrates the MH/MR transportation network in 1977. Unlike the AAA, MH/MR purchased privately supplied service mainly when its own vehicles could not meet the load. Although no quantitative data are available on excess capacity, it is likely that significant duplication existed between the AAA and MH/MR service networks.

In addition to these two major funding sources, a multitude of smaller agencies provided special transportation services in 1977. Throughout Allegheny County, at least 53 not-for-profit agencies offered some sort of transportation for their clients (not including AAA and MH/MR centers).

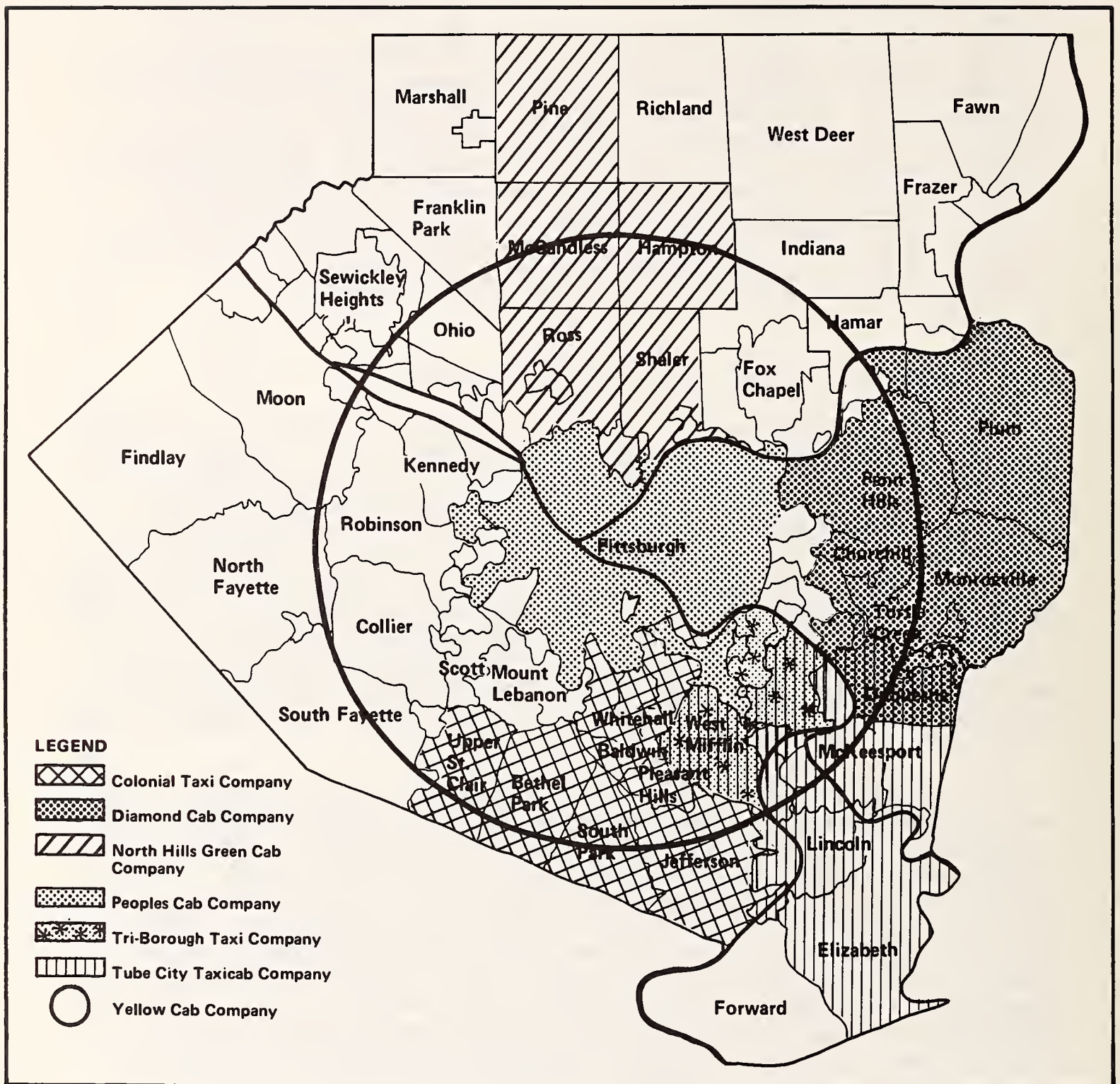

Figure 4-1. SERVICE AREAS OF TAXI COMPANIES PROVIDING PARATRANSIT SERVICE, 1977

SOURCE: Southwestern Pennsylvania Regional Planning Commission, 1979.

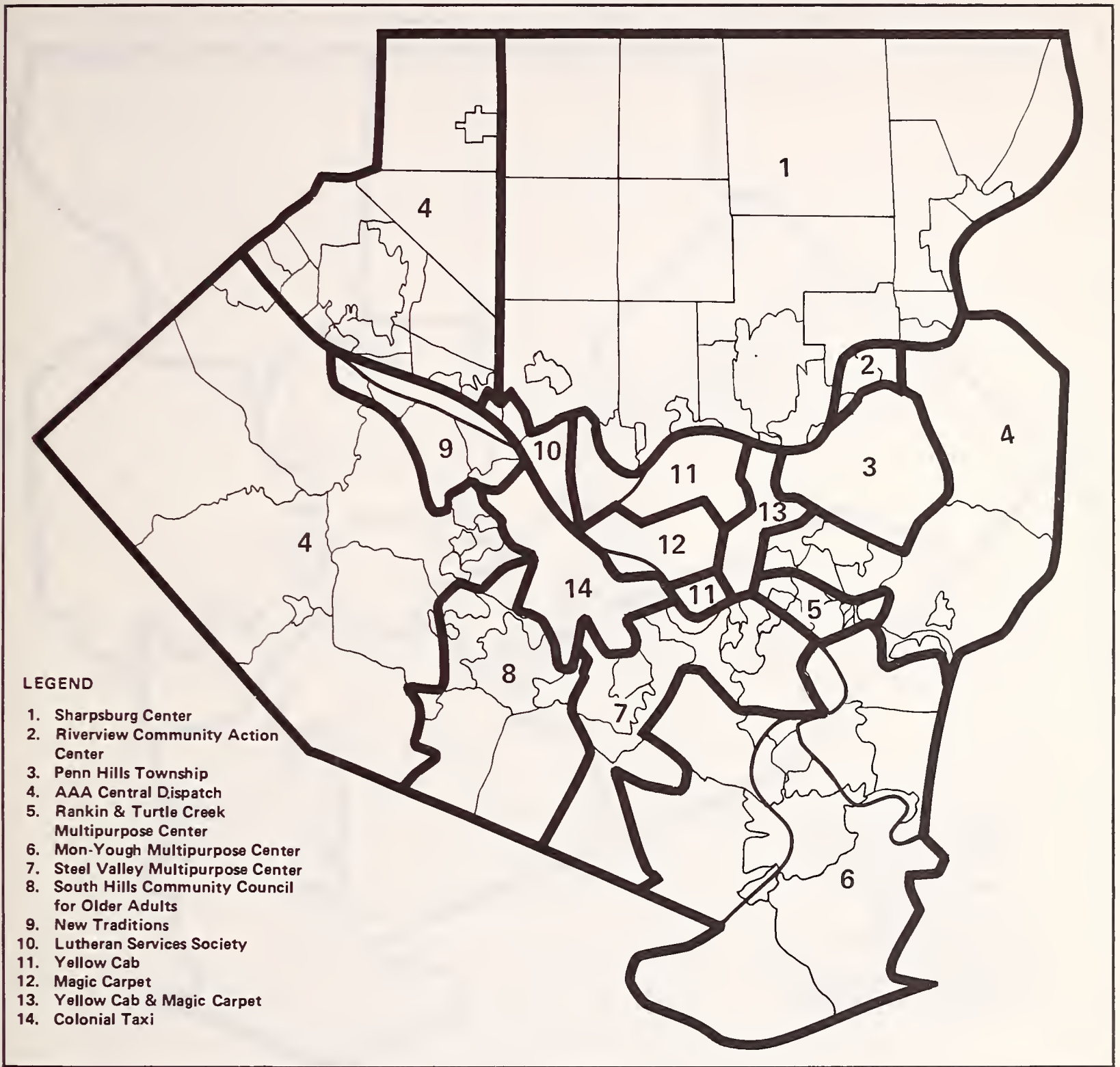

Figure 4-2. ALLEGHENY COUNTY ADULT SERVICES/AREA AGENCY ON AGING TRANSPORTATION SERVICE NETWORK, 1977

SOURCE: Southwestern Pennsylvania Regional Planning Commission, 1979.

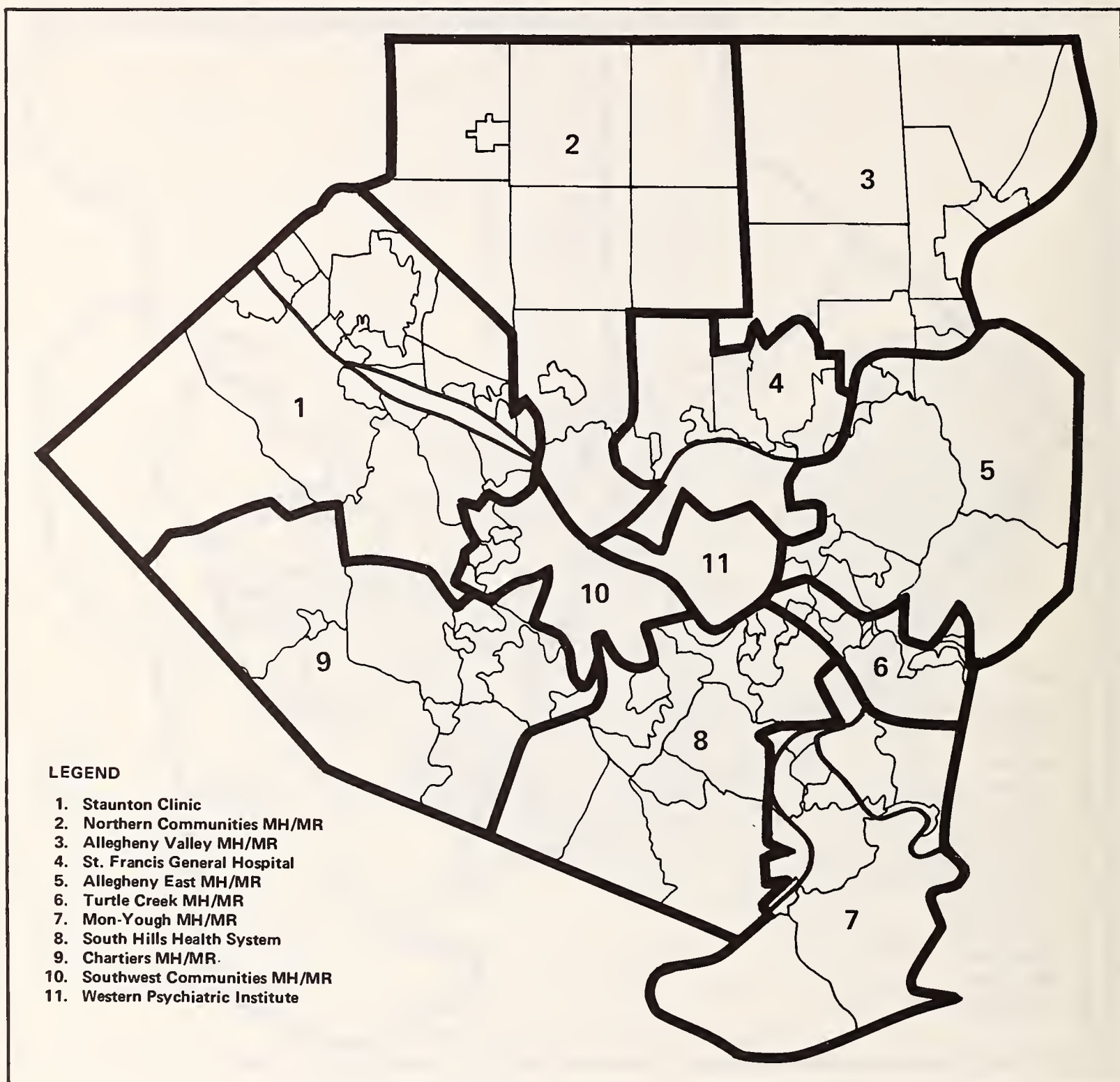

Figure 4-3. ALLEGHENY COUNTY MENTAL HEALTH/MENTAL RETARDATION PROGRAM TRANSPORTATION SERVICE NETWORK, 1977

SOURCE: Southwestern Pennsylvania Regional Planning Commission, 1979.

These agencies provided transportation either with their own vehicles or through for-profit carriers, as a complement to other services such as nutrition, medical, social, and recreational programs. The service areas of these not-for-profit agencies overlapped geographically but at the same time were very restrictive in that each served a narrowly-defined client group and made trips for particular purposes.

Of the agencies that provided their own service, only about 50 percent kept records that provide adequate information concerning ridership, cost of transportation, and vehicle capacities. This information is shown in Table 4-2. One should be aware that the cost figures do not include depreciation of capital or any estimated cost of volunteer labor. Also note that the figures in Table 4-1 showing the cost per passenger trip of for-profit carriers providing AAA-sponsored trips include depreciation allowances and costs of all personnel. Furthermore, while these are the only data available, they are flawed by inaccurate passenger trip totals. (See Section 5.3 for further explanation.) Therefore, the cost figures for for-profit carriers (Table 4-1) and those for not-for-profit carriers (Table 4-2) are not directly comparable.

4.1.4 PUC-Authorized, Not-for-Profit Carrier

One agency, Magic Carpet - Open Doors for the Handicapped, offered transportation as its sole operation and was certified by the PUC to provide paratransit service for the general public. Magic Carpet was, and continues to be, subsidized by Allegheny County and City of Pittsburgh contributions. It has traditionally supplied service only to the elderly and handicapped.

In 1977, Magic Carpet drew its patrons primarily from a limited segment of the city of Pittsburgh. With six wheelchair-accessible vans, Magic Carpet served only a minimal number of ambulatory persons, concentrating its service efforts on the nonambulatory. It operated seven days a week and offered service during the evening hours. Despite its limited service area, Magic Carpet was an important and unique resource for Pittsburgh's handicapped population. Unlike human service agency services, which were limited to specific trip purposes, Magic Carpet was available for trips with any purpose. Further, Magic Carpet was subsidized and, unlike private providers, its services were economically accessible to many nonambulatory individuals. In several ways, then, Magic Carpet can be seen as a forerunner of the Port Authority's ACCESS and user-side subsidy programs. It provided a visible, relatively unconstrained, and affordable service for the nonambulatory. Unfortunately, it was only available to a small segment of the Allegheny County population.

TABLE 4-2. CHARACTERISTICS OF TRANSPORTATION SERVICES PROVIDED BY TWENTY-FIVE AGENCIES IN ALLEGHENY COUNTY (1977)

Total Operating Expenditures	\$544,156
Total Vehicles	
Buses	4
Vans	65
Station Wagons	11
Sedans	4
Total Seating Capacity	556
Total Wheelchair-Accessible Vehicles	25
Total Wheelchair Capacity	43
Average Cost Per Vehicle Mile*	\$.95
Average Cost Per Passenger Trip*	\$4.41

*These are weighted averages and reflect large numbers of miles or trips provided by some agencies at high costs.

SOURCE: Southwestern Pennsylvania Regional Planning Commission, "Transportation Planning for Handicapped and Elderly Persons in the Southwestern Pennsylvania Region," Draft Planning Documentation Report, Vol. II, November 1978.

4.1.5 Availability of Paratransit Before Broker Implementation

Although our data are limited, we can draw some conclusions about the availability of paratransit supply before the demonstration. It is apparent that both for-profit companies and not-for-profit providers were important in providing services to the elderly and handicapped. Yet, not all areas of the county were well served. As shown in Figure 4-1, for-profit paratransit services were not available in large sections of the county. Furthermore, for-profit providers owned a total of only 24 accessible vehicles, enough capacity for 88 wheelchair passengers at one time. Much of this wheelchair-accessible capacity was devoted to service for local school boards, with whom Colonial, Yellow Cab, and North Hills had contracts. Services provided by agencies were limited geographically, to particular clients, and for specific trip purposes.

It also appears at first glance that for-profit providers had lower transportation costs than agencies. A number of factors, however, prevent us from drawing a firm conclusion on this point. First, we do not know the characteristics of the services provided by the two groups. Taxi costs are available only for trips sponsored by the AAA. AAA trips tend to be made by able-bodied elderly persons who can ride in taxis. Agency-provided trips, in contrast, included many van trips, which can be more costly to provide. On the other hand, agencies have historically tended to serve group trips, such as nutrition trips, in their own vehicles, but purchase service for single-passenger medical trips. By this reasoning, one would expect agency providers to have lower per-trip costs. Second, only about 50 percent of all agencies kept cost records. Non-reporting agencies may alter the cost figures substantially, although we cannot anticipate the direction of the change. Finally, we have no way to compare costs while controlling for variations in service quality. Thus, it is not possible to draw cost comparisons based on the available information.

The Southwestern Pennsylvania Regional Planning Commission (SPRPC) analyzed the availability of paratransit to the elderly and handicapped in 1977.* The major problems found by SPRPC were limitations related to geographic area and the high cost of service for unsubsidized users. Restrictions on travel by those confined to wheelchairs were found to be particularly severe, primarily due to a lack of accessible vehicles. Of 38 agencies providing transportation services to their clients, only 7 provided accessible service. These agencies covered only a small portion of the county and mainly operated outside the City of Pittsburgh.** As noted above,

*See Southwestern Pennsylvania Regional Planning Commission, "Transportation Planning for Handicapped and Elderly Persons in the Southwestern Pennsylvania Region," Draft Planning Documentation Report, Vol. II, November 1978.

**Ibid., p. 83.

only 3 for-profit carriers had wheelchair-accessible vehicles available, and 1 carrier, authorized to operate in the South Hills area only, accounted for 21 of these 24 vehicles. Magic Carpet operated six accessible vans and was an important resource to handicapped persons, particularly in the central areas of the county. Despite this resource, however, accessible service was largely unavailable in many areas of the county.

Where service was available, the cost to the user was much higher than regular transit services. In general, persons sponsored by agencies traveled free of charge but agencies typically sponsored trips only for medical or nutrition purposes, or to the agency itself. Persons not sponsored by agencies had two choices other than private transportation; they could travel by exclusive-ride taxi and pay full cab fare, or they could try to purchase shared-ride van service. Only Magic Carpet, which is subsidized by government contributions, regularly provided shared-ride van services to non-agency-sponsored travelers. Some other carriers were willing to provide such services, but few handicapped persons were able to make use of them at unsubsidized rates.

4.2 DESIRED IMPACTS OF THE BROKER ON PARATRANSIT SUPPLY

The brokerage demonstration was designed to remedy many of the deficiencies in the transportation delivery network for elderly and handicapped persons. The broker itself was positioned as a "marketplace coordinator." As such, the broker is able to "match" available paratransit supply with purchasers of paratransit service. It is designed to use, not replace, existing suppliers. In this role, it was hoped that the broker would be able to stimulate and coordinate supply and demand. Specifically, the broker was designed to alleviate the following deficiencies in the transportation delivery network.

1. Regulatory Barriers to Competition. Prior to the demonstration, there was little competition among paratransit providers, mainly as a result of regulatory control. Entry into the paratransit market was controlled by the Public Utilities Commission (PUC), and PUC authorization allowed paratransit carriers to operate only within specific service areas. As a result of these two factors, little direct competition among carriers occurred. After years of regulatory control over their exclusive-ride services, carriers seemed content to operate paratransit services in a non-competitive manner.

It was expected that the broker would foster competition among carriers to reduce the cost of paratransit service. At the outset of the demonstration, however, it was not clear how the broker would accomplish this. The Port Authority had filed suit, contesting PUC's right to regulate paratransit service. (This suit is discussed in greater detail in Section 1.) The Port Authority was eventually successful in this

suit, and the organization supported the relaxation of entry restrictions. Theoretically, the Port Authority could use relaxed entry restrictions to stimulate the creation of new paratransit providers and, hence, foster competition.

It should be noted, however, that the broker was not immediately in a position to benefit from relaxed entry restrictions. First, the broker established its initial contractual relationships with carriers before the regulatory issues were resolved. Hence, the ACCESS service network was originally designed in an uncertain regulatory environment. Second, the carriers themselves did not respond immediately to the regulatory changes. In response to the first few requests by ACCESS for carrier bids, the carriers bid mainly to serve their historic service areas. Third, the broker was operating under several objectives, only one of which was to foster lower transportation costs. As noted earlier, the provision of high-quality service by the broker was the highest priority of the Port Authority. The Authority believed that high quality was necessary to attract agencies to the broker system and to satisfy the elderly and handicapped communities and their representatives. This priority of the Port Authority limited the extent to which the broker could foster competition. For example, the broker set stringent service standards for its carriers and, as a result, several carriers initially were found to be unqualified to provide ACCESS service. With these constraints in place, the challenge for the broker was to establish a track record of high-quality service, attract agency participation, and, eventually, to use its resources to foster competition.

2. Lack of Coordination Among Carriers. Prior to the demonstration, individual carriers were serving limited markets and duplicating efforts. This situation was of concern to local transportation planners because there were no competitive forces present to minimize transportation costs. Without competition, duplicative efforts result in higher-than-necessary transportation costs. The efforts of human service agencies were of particular concern because they would be largely unaffected by regulatory changes. It was believed that the cost of agency-provided services could be reduced if these resources were coordinated so as to improve vehicle productivity.

The broker was designed to coordinate agency vehicle resources by bringing agencies into the ACCESS network as providers. It was expected that agency vehicles could be used to serve more trips if they were available to all ACCESS patrons rather than only the agency's clients. By controlling scheduling and the distribution of ACCESS trips among providers, it was hoped that the broker could improve vehicle utilization. With these responsibilities, the broker was expected to reduce unnecessary duplication and increase ridesharing.

There were significant institutional barriers to the broker's achievement of these desired objectives. First there was a historical

tension between for-profit and not-for-profit carriers. For-profit carriers believed that not-for-profit agency carriers were being unfairly subsidized by governmental grant programs. Thus, they objected to competing directly against not-for-profit agency carriers. The broker had to overcome these objections and develop procedures whereby the two types of carriers could operate as a system. Second, not-for-profit agency carriers were ill-equipped to compete with for-profit carriers. How could the broker reconcile the presence of non-competing carriers with the encouragement of competition? An important task of the broker, therefore, was to manage the bidding process so as not to exclude agency carriers (if they could not compete) while ensuring that these carriers produced service at the lowest cost (and to do this in the context of encouraging competition among other providers).

3. Low Service Quality and Quantity. Some Allegheny County agencies and many elderly and handicapped individuals believed that the quality of service provided by for-profit carriers did not meet agency standards. It was desired that the broker improve the quality of service offered to elderly and handicapped persons in Allegheny County. The broker had several options available to it for encouraging service quality improvements. First, the Port Authority entrusted the broker with the right to enforce some of its regulatory requirements for paratransit carriers within the ACCESS system. These requirements include vehicle safety and driver training standards.

Second, the broker was empowered to act as a representative of the elderly and handicapped in dealing with carriers. Prior to the institution of the brokerage, most paratransit consumers were unorganized. Only large agencies, such as the AAA, represented large numbers of paratransit trips. Many smaller agencies and individuals perceived that their requests bore little weight with carriers, as only a few or no alternative providers were available. The broker was positioned as a type of purchasing agent for paratransit consumers. It was expected that this coordination of demand would strengthen the requests of paratransit consumers.

It was also believed that the broker could stimulate an increase in the quantity of paratransit services. The ability of the broker to do so is obviously constrained by the number and type of trips that institutions and individuals want to purchase through ACCESS. Service can only be provided to the extent that someone is willing to pay for it.

The broker was greatly aided in its attempts to increase service quantity by its affiliation with two funding sources. First, it was aided by the SMD grant, which allowed the broker to purchase service from providers even when the cost of service could not be fully covered by contributions from purchasers. As noted earlier, this type of funding was provided by the scrip-risk account. Second, the broker was aided by the Port Authority, which also provided deficit-funding for the

broker as well as a user-side subsidy program for persons unable to use fixed-route transit. The user-side subsidy program represents a very significant decrease in the cost of service to eligible persons and it undoubtedly brought many trip requests into the ACCESS system that would not have come to the broker without the subsidy. Without these external funding sources, it is unlikely that ACCESS purchasers could have supported the range of services the broker was expected to supply.

In exploring the impact of the broker on paratransit supply, we will investigate the success of the broker in achieving these desired market changes. The broker's ability to influence paratransit supply stems from its four major "powers," which are described below. Each of these powers may be used by the broker to improve one or more aspects of service provision.

Perhaps the foremost power of the broker is its control over the distribution among paratransit carriers of thousands of monthly trips. The broker can demand that carriers meet certain qualifications before they join its carrier network. This power of the broker can be termed control of entry, as it is derived from the broker's ability to limit access to that portion of the paratransit market under its control. The broker can also exercise its control of entry in assigning certain market segments to one carrier in an effort to increase ridesharing. These actions of the broker can be considered long-term in nature.

A second power of the broker is its ability to direct trips to the most cost-effective producer during daily operations. We can refer to this power as trip assignment. In assigning trips, the broker must consider both cost and service quality. For this reason, the carrier with the lowest per-trip costs may not be assigned all trips in its service area. Furthermore, in the interest of service quality, the broker may not choose to pursue every opportunity to organize shared rides. The broker's ability to assign trips to carriers on a short-term basis, however, does provide it with an important tool for improving vehicle productivity.

Third, the broker can act as a consultant to carriers, advising them on ways to improve service quality and productivity. By monitoring operations records, the broker can document carrier performance and analyze options for carrier improvement. If good relations exist between broker and carrier, the carrier may be persuaded to make recommended improvements. The broker deals from a position of strength as a consultant in that it controls trip assignment.

Fourth, the broker can act as a marketing agent for paratransit service. Marketing complements the broker's other functions, as it brings more trips under its control. Marketing also performs a public service in making individuals aware of the services available to them.

It should be noted that carriers may also exert power over the broker, particularly those carriers on whom the broker relies heavily. If an

individual traveler or agency calls the broker, it must be able to provide the necessary transportation service. If the broker is unable to deliver, its credibility as a market place coordinator is weakened. The broker must rely on the carriers to supply this service. Consequently, the broker cannot push carriers too hard for various service improvements if such actions will jeopardize its own ability to function. In this sense, the relationship between the broker and its service providers can be seen as a symbiotic one, in which each party mutually benefits from the other. The more carriers that are available to a broker, however, the less dependent it is on any one carrier; the broker can be more powerful in influencing carrier behavior.

The role of a market coordinator is a difficult one because, in order to promote efficient market outcomes, the broker must stimulate competition. Competition creates both winners and losers; some carriers may be unable to compete. In the marketplace, such a carrier would probably go out of business. Is the broker strong enough to allow such a result if circumstances call for it? Likewise, some consumers will find that their demands remain unsatisfied. Carriers they prefer may be too expensive, and the broker may switch the consumer to a less-preferred provider. In seeking efficient market outcomes, the broker must withstand consumer disapproval as well as the results of competition. Such a position is undoubtedly difficult to achieve.

4.3 INFLUENCE OF THE BROKER ON THE PARATRANSIT INDUSTRY

In this subsection, we examine the influence of the broker on each of the three industry characteristics discussed above. These characteristics are: 1) regulatory barriers to competition; 2) a lack of coordination among carriers; and 3) low service quality and quantity.

4.3.1. The Reduction of Regulatory Barriers and the Promotion of Competition

The promotion of competition by the broker is important because competition forces carriers to produce transportation services at the lowest possible cost. As noted above, there were a number of factors that inhibited the broker, ACCESS, from taking immediate advantage of competitive forces. These were the timing of the resolution of regulatory issues, a lag in the response of paratransit providers to regulatory changes, and the decision of the Port Authority to make service quality the highest priority of the broker. Because of these factors, competition among carriers to provide ACCESS service was slow to develop. Eventually, however, the broker was able to engender competition, as evidenced by the number of carriers participating and changes in carriers' service areas.

4.3.1.1 Number of Carriers Participating - A competitive market is often characterized by the entry and exit of firms. An examination of the pool of carriers serving ACCESS indicates that this characteristic of a competitive market was not present until 1982. From 1979 to 1982, ACCESS relied heavily on two for-profit carriers for service provision. These two carriers, Yellow Cab Co. and Colonial Taxi and Paratransit, joined the ACCESS network at its inception and have historically provided about 65 percent of ACCESS trips. These two carriers served the elderly and handicapped for many years prior to ACCESS, mainly through school board and human service agency contracts. Both carriers continue to serve these markets as well as ACCESS.

Tube City Paratransit, another large for-profit carrier, joined ACCESS after the broker's first year of operation. Since that time, Tube City has become an important provider of ACCESS service, serving approximately 6 percent of all trips. Tube City's unique contribution to the ACCESS network is its service to an area (the southeastern portion of the county) not well-served by other carriers. Like Yellow Cab and Colonial, Tube City had served the elderly before its ACCESS contract, but unlike the others it did not provide service to the handicapped.

Toward the end of the demonstration, three other for-profit carriers were allowed to serve the ACCESS network. These three, Amram Enterprises, North Hills Transportation Service, and Tri-Borough Taxi, all signed ACCESS contracts in January 1982 and are all small providers. Each firm had been approached by ACCESS during earlier contracting periods. North Hills is a small company that did not have the resources to participate earlier. The other carriers did not participate at an earlier date because they failed to meet the minimum entry requirements set by ACCESS. By 1982 ACCESS had the resources to give these carriers a chance to prove themselves. Amram Enterprises was unable to produce the service records required by ACCESS and it left the network in 1983.

Two other Allegheny County for-profit providers, People's Cab and Diamond Cab, did not participate in ACCESS during the demonstration although they had been informed of the network and its carrier requirements. Diamond Cab is a small company that serves limited outlying sections of the county. People's Cab was a troubled company until its purchase by a research organization affiliated with Carnegie-Mellon University. Through this association, its service record improved and ACCESS was able to bring People's Cab into its network in April 1984.

Five not-for-profit carriers serve ACCESS trip requests. These carriers, with one exception, serve both agency-sponsored trips and trip requests from unaffiliated patrons. (Chartiers MH/MR serves only its own agency trips. Chartiers participated in ACCESS only after it was agreed that such participation would offer the best method for regulating its shared-ride service.) Of the remaining four not-for-profit carriers, three are human service agencies. These three, Steelworkers Oldtimers Foundation, Focus-On-Renewal, and The Center, provide service in areas that are also served by

larger for-profit carriers. Together they account for between 9 and 10 percent of all ACCESS service. The remaining not-for-profit carrier, Magic Carpet, is solely a transportation provider. Magic Carpet provides only lift-van service. All of these carriers, except Chartiers MH/MR, joined the ACCESS network at its inception. Since then, the number of not-for-profit carriers in the network has remained stable.

No new paratransit carriers, either for-profit or not-for-profit, entered the market as a result of the demonstration. Two factors may have discouraged new carrier entry. First, taxi companies providing paratransit service often rely on exclusive-use service for a major portion of their business. PUC regulation, which restricts entry into the exclusive-use market, may well have dampened entry by carriers wishing to serve both exclusive-use and shared-ride markets. Second, ACCESS' own carrier evaluation criteria and qualification guidelines may have thwarted entry for several years. The evaluation criteria used by ACCESS include an assessment of both the carrier's past commitment to providing elderly and handicapped services and its ability to continue providing service to this market. This criterion favors carriers with a prior track record.

By 1982, ACCESS was in a position to more vigorously pursue an open-entry policy. The broker had achieved a favorable track record with many agencies by that time and cost considerations were beginning to take on a new importance. With the end of the demonstration in June 1982, the Port Authority assumed full responsibility for providing funding for transportation deficits of the broker. Prior to that time, the Authority had provided significant funding for the broker but a large portion of its transportation deficit had come from the Federal grant. ACCESS' pursuit of cost control measures reflects in part this additional exposure of the Port Authority to the full burden of ACCESS transportation deficits.

As noted above, in January 1982 ACCESS allowed three new carriers to join its service network. Two of these carriers had not met the broker's service standards in earlier years. ACCESS, however, relaxed its standards in 1982 to attract new carriers into the network. These carriers were viewed as having two cost-controlling effects. First, the carriers are located in areas of the county that other providers find difficult to serve. For example, Yellow Cab was serving trips in the North Hills area, often with long deadheading. North Hills Transportation Service is located in the North Hills and can serve many of the trip requests in this area at a lower cost.

The second cost-related influence of the new carriers is that they represent competition for other ACCESS carriers. The cost bids presented by the new carriers to ACCESS were lower on average than those of continuing carriers. The ACCESS manager was able to use this fact in carrier negotiations, resulting in cost concessions from some carriers. These actions are an important sign that competition is developing within the ACCESS network. It must be noted, however, that no carrier has ever been dropped from the network.

4.3.1.2 Geographic Availability and Changes in Carrier Service Areas - Prior to the demonstration, some areas of Allegheny County were not served by any paratransit provider. These outlying areas are among the least populated sections of the county. Other geographic areas received only sparse coverage, with one carrier of limited paratransit capacity providing service for a large section of the county. Only the central, more densely populated areas of the county were covered by numerous paratransit vehicles. Throughout the county, carriers were not flexible in their ability to provide service. PUC authorizations defined the service area for each for-profit provider, limiting its response to service requests outside this area. Not-for-profit carriers provided service only in certain areas, for specific client groups and trip purposes.

The carrier network assembled by ACCESS supplies service throughout the county. At the beginning of the demonstration, providing county-wide service was difficult for the broker because it required that some carriers' areas be stretched beyond those that they had traditionally served. The result was lower-than-average vehicle productivity when carriers provided trips outside their operational bases.

At that time, the service areas of ACCESS carriers did not overlap to any large extent. For-profit carriers bid to serve their traditional service areas, with little encroachment on each other's territory. ACCESS' early dispatching and scheduling design essentially separated the market of for-profit and not-for-profit carriers by funneling intra-area trips to the not-for-profit carriers. Inter-area trips and some intra-area trips were directed to the for-profit carriers. Thus, even though they served the same geographic area in some cases, for-profit and not-for-profit carriers were not engaged in direct competition. Figure 4-4 illustrates the ACCESS network in 1979. As can be seen, only two areas were served by multiple carriers, a for-profit and a not-for-profit carrier in both cases. In one area, the markets of the two carriers involved were distinguished by whether or not lift service was required; in the other area, the market was distinguished by local or non-local trip requests. It can also be seen that the northeastern portion of the county was served primarily by a not-for-profit carrier, The Center.

By 1983, the service areas of ACCESS carriers overlapped to a greater extent, reflecting the more competitive character of ACCESS service provision. This competition appeared in contract negotiation and in day-to-day operations. Where two carriers serve the same area, unaffiliated users are given a choice of carrier. In fact, as illustrated by Figure 4-5, the overlapping of service areas is quite extensive, particularly in the central and southeastern regions of the county.

The adjustment of carriers' service areas has not always been painless. Carriers generally dislike reductions in their service areas, except in the few cases where carriers' resources have been severely taxed by their agreement to provide ACCESS service in an outlying area of the county. Only

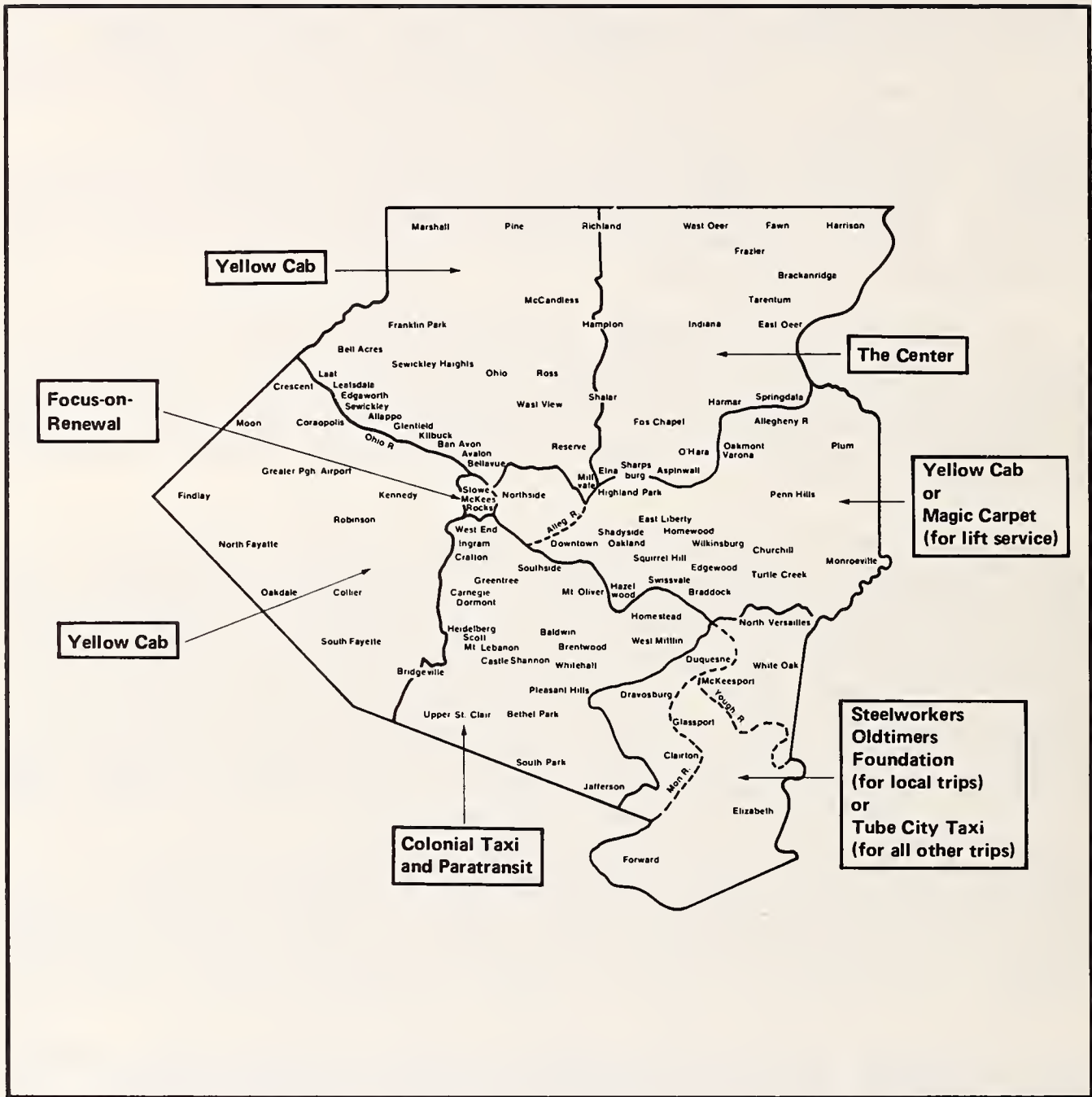

Figure 4-4. GEOGRAPHIC SERVICE AREAS OF ACCESS CARRIERS, 1979

SOURCE: ACCESS.

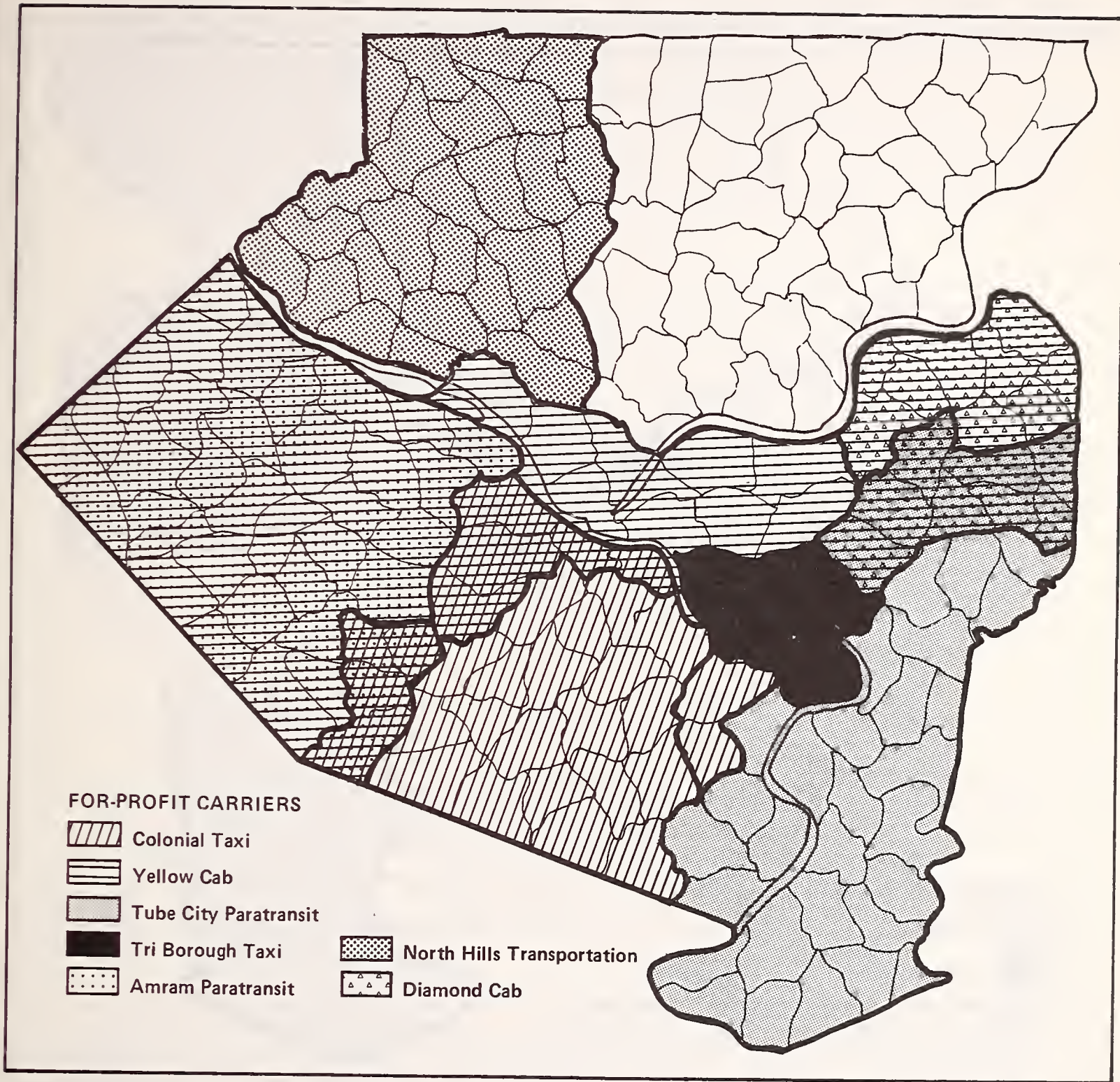
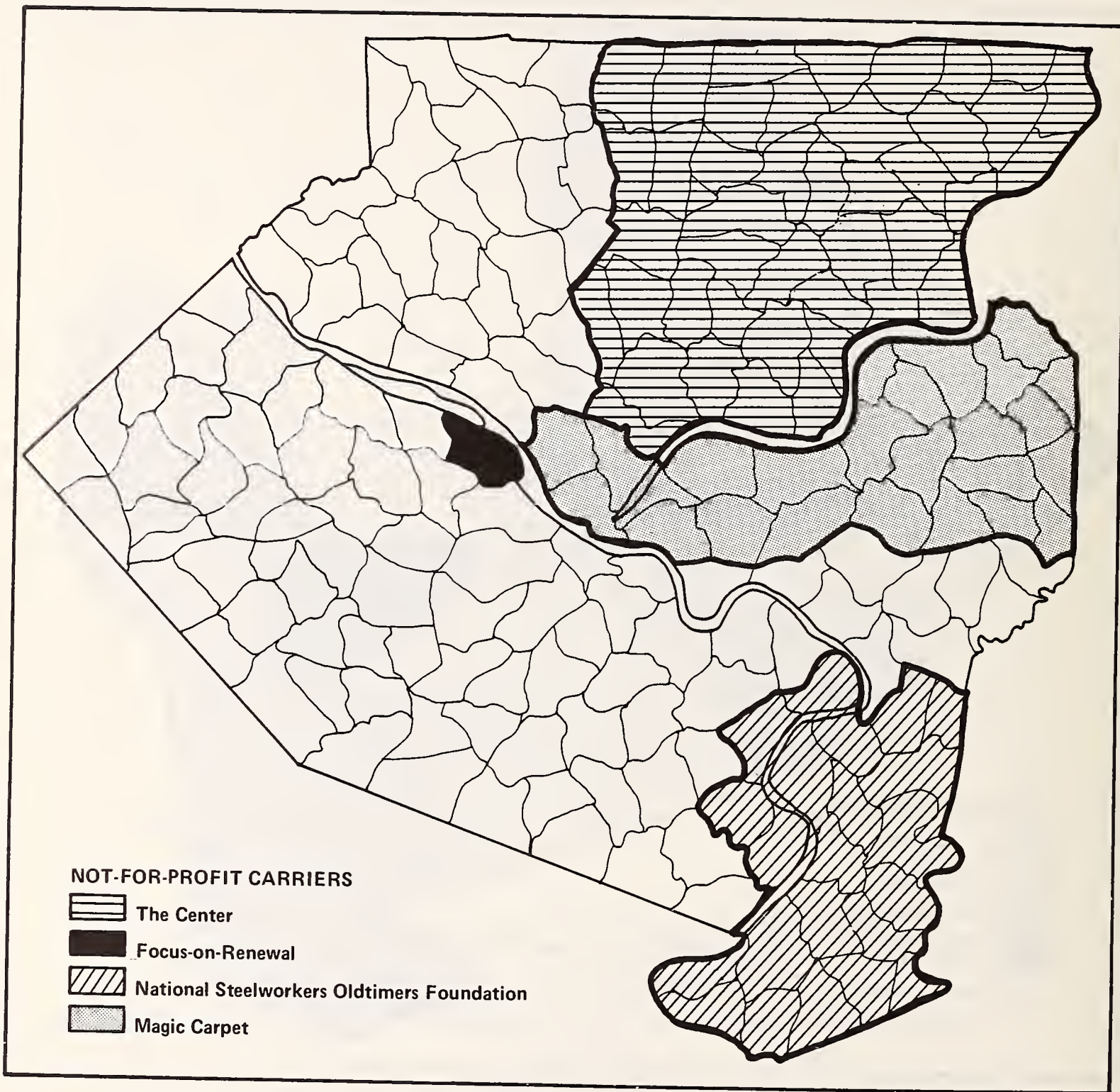

Figure 4-5. GEOGRAPHIC SERVICE AREAS OF ACCESS CARRIERS, 1983

SOURCE: ACCESS.



SOURCE: ACCESS.

Figure 4-5 (continued). GEOGRAPHIC SERVICE AREAS OF ACCESS CARRIERS, 1983

one carrier, The Center, has had its service area significantly reduced. Traditionally, The Center had served many trips west of its formal AAA service area. This northwestern corner has not always been well served by other carriers and The Center acted to fill the gap. ACCESS, however, believes that other carriers now can serve the area more effectively and it has limited the Center to a narrower portion of the county than it had formerly served. Staff at The Center believe that they could serve a larger area effectively and regret having to deny service to former patrons. Other carriers have recently had their service areas reduced not by assignment but by competition. This process has produced some strain in carrier relations, but carriers seem to view reductions due to competition more philosophically than they view reductions by administrative fiat.

In contrast, some carriers have had their service areas extended over time and this has also produced some difficulties for the broker. As noted earlier, some carriers have been asked to respond to trips quite distantly removed from their operational bases. In the first year of operation, Yellow Cab had difficulty serving trips in one section of its large service area without numerous late vehicle arrivals. This situation was difficult for the broker to resolve because of the limited resources of other carriers. Resolution occurred when the broker was able to shift these trips to another carrier willing to purchase a new van to provide service to the sector. Another carrier, Magic Carpet, now serves a larger portion of the county than it did before the demonstration, when it served only a small segment of the city of Pittsburgh. The expansion of its service area has increased the demands on Magic Carpet's management, demands which they have not always been able to meet. This, in turn, has increased the amount of effort the broker must devote to monitoring this carrier's trip requests and schedules.

4.3.2 Coordination of For-Profit and Not-For-Profit Carriers

One objective of the demonstration was the coordination of human service agency vehicles with other paratransit resources. ACCESS' experience with this type of coordination suggests that it is more difficult to achieve than was perhaps previously believed. The broker has been successful in attracting only a portion of the human service agency vehicles in the county to its service network. Furthermore, there is little reason to believe that additional coordination would be beneficial for the agencies or that it would have a positive impact on the broker's transportation network.

Only a portion of the county's human service agencies have chosen to participate in the ACCESS network. Importantly, Magic Carpet, a visible symbol of community support for services to the handicapped, participates. Of the 10 agencies providing service in the AAA network, two participate in ACCESS -- The Center in Sharpsburg and the Steelworkers Oldtimers Foundation (formerly Mon-Yough Multipurpose Center). Within the MH/MR network, only one agency, Chartiers, is affiliated with ACCESS. It is affiliated for regulatory purposes and it provides transportation solely to its own clients,

as discussed in Section 3.1.1 above. Of the many, varied agencies outside the AAA and MH/MR umbrellas, Focus on Renewal is the only one to participate in the ACCESS network. Other agencies were originally encouraged to participate, and some expressed interest, but no other agencies have served ACCESS as carriers.

Figure 4-6 shows the distribution of monthly trips between for-profit and not-for-profit carriers. It can be seen that the number of trips provided by not-for-profit carriers has grown but not to the extent that the number of trips by for-profit carriers has. Since March 1981, the number of trips provided by not-for-profit carriers has remained close to 4,000 per month. Since that time, the average number of monthly trips by for-profit carriers has gradually increased.

The four not-for-profit carriers that participate actively in ACCESS -- Magic Carpet, The Center, Steelworkers Oldtimers Foundation, and Focus on Renewal -- have developed relationships with the broker that have remained basically unchanged throughout the demonstration. As noted above, Magic Carpet and The Center experienced changes in their service areas when they joined ACCESS but such major changes have not occurred since that time. Three of the four carriers indicated in interviews that their relationships with ACCESS were beneficial. They believe that affiliation with the broker has allowed them to achieve higher vehicle productivities because they can mix other trip requests with those of their own clients. They also assert, however, that affiliation with ACCESS has placed new demands on them, particularly with respect to managing their transportation programs.

In contrast to the majority of agency carriers, one agency believes that serving ACCESS has not only not improved its productivity but has created additional administrative rules and procedures instead. The source of some of this frustration was a loss of control by this agency over the provision of transportation to its clients. Furthermore, the agency continued to handle complaints from its clients but no longer had the power to resolve the issues raised. ACCESS has tried to work with this agency in resolving this difficulty. Despite these problems, however, the agency is unlikely to withdraw from the network because it would lose two-thirds of its trip requests as a result.

Like for-profit carriers, the not-for-profit carriers provide both agency-sponsored trips and trips by unsponsored individuals. The role of the not-for-profit carriers differs from that of the for-profit carriers, however. These carriers specialize in local or intra-area trips, although not to the exclusion of inter-area travel. Magic Carpet is unique in that it provides only lift-van service. As a group, the not-for-profit carriers play an important role for ACCESS but this role appears to be a limited one. Moreover, the broker does not look to these carriers to serve new trips.

It is useful to highlight the differences between the two types of carriers because they illustrate the extent to which the system can truly be

NUMBER OF TRIPS

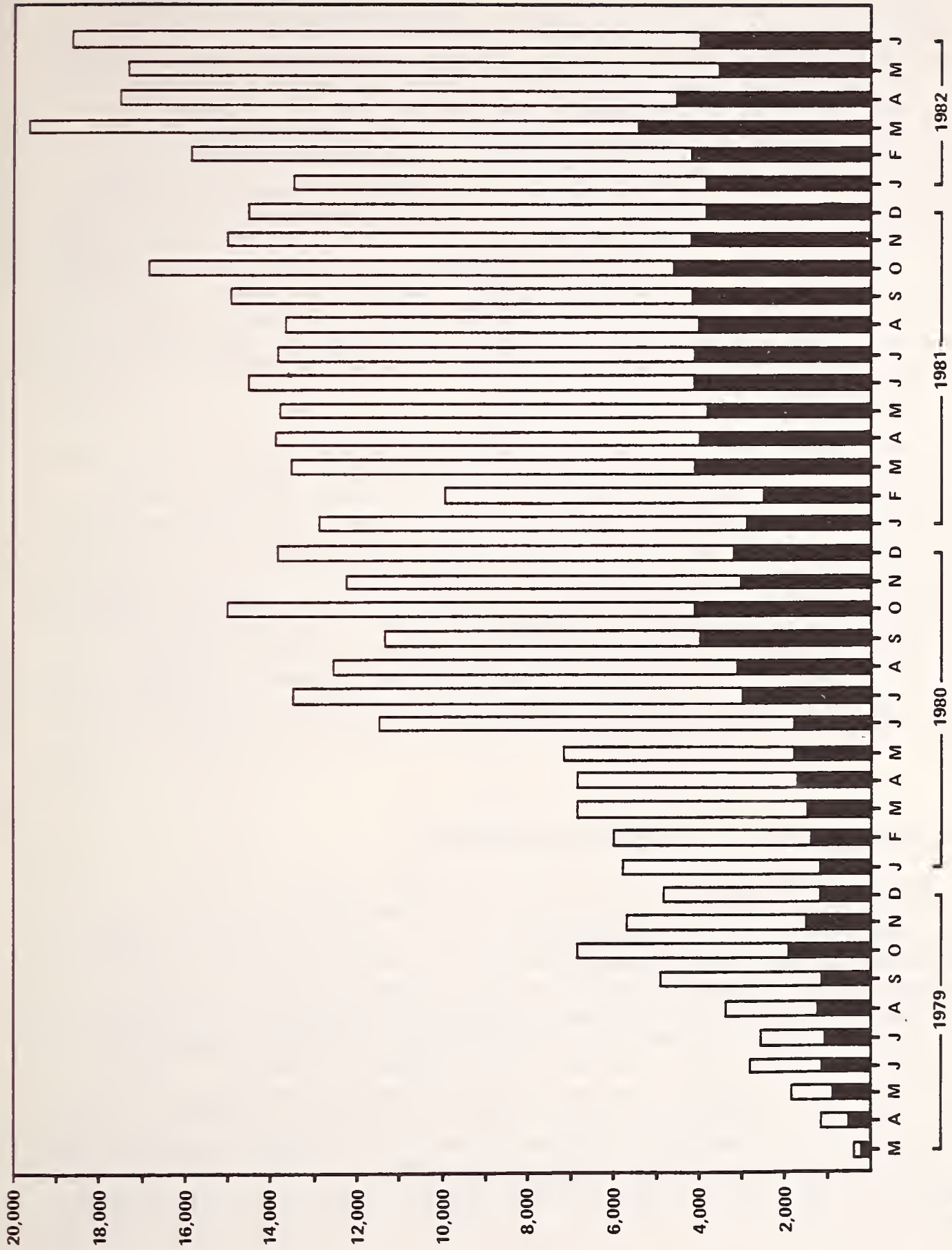

Trips Provided by For-Profit Carriers
Trips Provided by Not-For-Profit Carriers

SOURCE: ACCESS Operations Reports, Nos. 1-40.

Figure 4-6. NUMBER OF TRIPS PROVIDED BY FOR-PROFIT CARRIERS AND NOT-FOR-PROFIT CARRIERS

termed "coordinated." While the two types of carriers are fused by the broker into an integrated service delivery, the relationship of the not-for-profit carriers with the broker is very different from that of the for-profit carriers. The not-for-profit carriers are bound by different rules than are the for-profit carriers, simply because they are not part of a competitive market. First, the not-for-profit carriers differ from the for-profit providers in that they do not submit competitive cost bids to ACCESS. The broker audits the not-for-profit carriers and reimburses them on a fully-allocated cost basis. The ACCESS manager has met with several not-for-profit carriers to discuss improved productivity, just as he has met with for-profit carriers. Unlike the for-profit carriers, however, the broker cannot rely on competition to enforce its productivity goals. Second, the broker cannot realistically remove an agency from the ACCESS network. It would not be acceptable politically unless such a decision were reached mutually. In contrast, ACCESS can refuse to purchase service from one of its for-profit carriers if a cost bid is too high.

In several ways, then, the not-for-profit carriers form a distinct segment of ACCESS' provider network and the two groups of carriers are not fully coordinated. In the ACCESS network, the for-profit providers and the agency providers do not actively compete with each other. This can be seen as a necessary accommodation of the broker to the fundamental differences of the two organizational types. From it, the broker gains a situation wherein the two groups co-exist, without active resistance from for-profit carriers claiming unfair competition from subsidized carriers. The broker also gains the credibility attached to agency-provided services and their reputed concern for the safety and comfort of elderly and handicapped passengers. The broker forfeits, however, active competition for a significant portion of its market, with nearly one-quarter of the trips served by the not-for-profit carriers.

4.3.3 Improvements in Service Quality and Quantity

4.3.3.1 Vehicle Availability - Table 4-3 lists the ACCESS vehicle fleet by type of vehicle and carrier. These vehicles are used by the carriers for all purposes, including ACCESS. Comparing this table to Table 4-1, one can see that the number of vans and lift-equipped vans owned by for-profit carriers has increased since the time of demonstration implementation. In 1977, for-profit carriers had a total of 113 vans, including 24 accessible vehicles. By 1982, for-profit carriers owned at least 98 vans (Tube City Paratransit did not report its fleet size), including 39 accessible vehicles. Not-for-profit carriers in the ACCESS fleet own an additional 18 wheelchair-accessible vehicles, bringing the total number of accessible vehicles in the ACCESS fleet to 57. An important feature of the ACCESS accessible-vehicle fleet is its even distribution throughout the county. In 1977, only the city of Pittsburgh and the South Hills area were served by accessible paratransit vehicles.

TABLE 4-3. CHARACTERISTICS OF ACCESS CARRIER FLEETS, JUNE 1982

	Vehicles			
	<u>Vans</u>	<u>Lift- Vans</u>	<u>Sedans</u>	<u>Buses</u>
<u>For-Profit Carriers*</u>				
Tube City	N.A.	2	N.A.	0
Yellow Cab	55	9	350	35
Colonial	30	19	120	7
Tri-Borough	10	0	11	0
Amran Enterprises	0	0	3	0
North Hills Transportation Service**	<u>3</u>	<u>9</u>	<u>1</u>	<u>0</u>
Subtotal, For-Profit Carriers	98+	39	485+	42
<u>Not-for-Profit Carriers***</u>				
The Center	5	4	4	0
Focus on Renewal	0	2***	0	0
Steelworkers Oldtimers Foundation	2	1	2	0
Magic Carpet	0	11	0	0
Chartiers MH/MR	<u>4</u>	<u>0</u>	<u>0</u>	<u>0</u>
Subtotal, Not-for-Profit Carriers	<u>11</u>	<u>18</u>	<u>6</u>	<u>0</u>
Total, All Carriers	109+	57	491+	42

*Diamond Cab, shown in Figure 4-5, came into the program after June 1982.

**This firm is unrelated to the firm of similar name appearing in Table 4-1. The latter, mostly a school bus operator, did not participate significantly in the program, and is no longer operating.

***Ramp-equipped.

N.A. = Not Available.

SOURCE: ACCESS Manager.

While for-profit carriers also use their vehicles to provide service to other clients, particularly local school boards, it is likely that increased trip demand resulting from the demonstration caused this expansion in the accessible-vehicle fleet. ACCESS demand for accessible vehicles has increased; their use by the school board has declined. There are fewer school-age children in Allegheny County as a result of population declines and a shift in the age distribution. Therefore, fewer trips have been provided in recent years under school board contracts. Meanwhile, ACCESS ridership has grown steadily, totaling over 15,000 monthly trips by early 1982.

4.3.3.2 Service Hours - Prior to the demonstration, paratransit service was available primarily to agency clients through agency contracts with providers. Transportation was sponsored in accordance with agency rules, with each agency following its own procedures. The overwhelming majority of agency trips were provided between Monday and Friday during agency business hours. Carriers supplied only a small amount of paratransit service after hours and on weekends. This arrangement is not surprising, given that little demand existed for service not sponsored by agencies due to its high cost.

In contrast, ACCESS trips can be taken between 6:00 a.m. and 12:00 midnight. Table 4-4 shows the service hours of ACCESS carriers. All ACCESS carriers, except Chartiers MH/MR, provide service during the period of greatest trip demand -- between 6:00 a.m. and 6:00 p.m., Monday through Friday. Three carriers provide service 24 hours per day.

ACCESS originally offered service Monday through Friday, from 6:30 a.m. to 10:30 p.m. As part of its strategy to make service improvements gradually, the network instituted Saturday service in July 1979. Sunday service was first offered one year later in July 1980. Five ACCESS carriers, Yellow Cab, Colonial, Magic Carpet, Tube City, and Focus on Renewal, provide Sunday service. Demand is low enough that these carriers can cover all trip requests. Initially, all requests for Sunday service were scheduled through the ACCESS office, requiring patrons to place trip requests on the preceding Friday. A survey of ACCESS riders indicated that many found this requirement constraining; trips for these services are now scheduled directly with carriers. ACCESS' one-day-in-advance reservation procedures are still in effect for weekend service requests. Also in response to rider requests, service hours have been extended from 6:00 a.m. to 12:00 midnight seven days a week.

4.3.3.3 Advance Reservation Requirement - Prior to the demonstration, most paratransit services had a one-day-in-advance reservation requirement. Since its inception, ACCESS has continued this procedure, requiring that all trip requests be made one day in advance. Patrons must place trip requests by 3:00 p.m. on the day preceding the day of service. Requests may be placed further in advance and requests may be made for regularly-scheduled pickups.

TABLE 4-4. SERVICE HOURS OF ACCESS CARRIERS

	<u>Operating Hours</u>	<u>Operating Days</u>
<u>For-Profit Carriers</u>		
Tube City	24 hours	7 days
Yellow Cab	24 hours	7 days
Colonial	24 hours	7 days
Tri-Borough	7:00 a.m.-9:00 p.m.	Monday-Saturday*
Amram Enterprises	6:00 a.m.-6:00 p.m.	Monday-Friday*
North Hills	6:00 a.m.-6:00 p.m.	Monday-Friday*
<u>Not-for-Profit Carriers</u>		
The Center	6:00 a.m.-6:00 p.m.	Monday-Friday
Focus on Renewal	6:00 a.m.-10:00 p.m.	7 days
Steelworkers Oldtimers Foundation	6:00 a.m.-6:00 p.m.	Monday-Friday
Magic Carpet	6:00 a.m.-12:00 p.m.	7 days
Chartier MH/MR	8:00 a.m.-5:00 p.m.	Monday-Friday

*Operates 7 days when requested by ACCESS.

SOURCE: ACCESS Manager, June 1982.

In July 1981, as part of the demonstration, the broker began to provide same-day service. This feature allows ACCESS patrons to place trip requests for Monday-through-Friday service with advance notice of two hours. Agencies must still schedule trips one day in advance. All carriers accept these reservations. An important restriction on the use of this service is that carriers can only serve these trips with pre-scheduled capacity. Carriers cannot use exclusive-ride taxis to fill such requests and cannot accept this type of trip order between 9:00 p.m. on Friday and 7:00 a.m. on Monday or after 9:00 p.m. on any evening.

These restrictions have been placed on the same-day reservation service for two reasons. First, the ACCESS manager believes that allowing same-day service without capacity restrictions would result in many exclusive-ride taxi trips and limit the carriers' ability to pre-arrange shared-ride trips. Second, the main beneficiaries of unrestricted same-day service would be the ambulatory and semi-ambulatory who are able to ride in taxis. Service to nonambulatory individuals would be constrained by the availability of accessible vehicles, most of which are already in service during weekdays. Thus, the capacity restriction can be seen as an attempt to provide a similar quality of service to all riders. With these restrictions, same-day trips account for approximately 5 percent of all requests by unaffiliated users, and it is not known how many of these requests are refused. ACCESS management believes that few regular ACCESS riders take the risk of same-day service requests.

4.4 INFLUENCE OF THE BROKER ON VEHICLE PRODUCTIVITY, SERVICE QUALITY, AND TRANSPORTATION COSTS

The ultimate goal of many of the broker's actions regarding paratransit supply was to improve the productivity of the total paratransit network while increasing the amount of service provided to the elderly and handicapped community. Because the broker was called upon to achieve productivity improvements while substantially expanding supply, it is difficult to assess its effect on productivity and costs alone. The paratransit industry in Allegheny County has changed dramatically since the broker's inception. Most importantly, the Port Authority's user-side subsidy program has brought hundreds of people into the market for paratransit services, and they are requesting thousands of monthly trips that were not previously provided. For this and other reasons, the "average" paratransit trip requested from the broker is very different from the "average" trip requested before the demonstration. This change makes it difficult to construct a fair before-and-after comparison of the broker's impact on productivity and costs.

In this subsection, we examine the track record of the broker with regard to vehicle productivity, service quality, and the cost of service. To the extent possible, we have attempted to construct valid comparisons, and we draw the reader's attention to the caveats included in the text. While we note that it is difficult to draw conclusions about the broker's influence on

the changes in the county paratransit network as a whole, the following analysis does provide an accurate picture of the productivity and cost characteristics of the ACCESS network. Thus, it is indicative of the levels of costs and ridesharing other localities may experience if they implement a similar system.

4.4.1 Vehicle Productivity

As part of the evaluation, samples of driver manifests were examined for three service periods -- one prior to demonstration implementation and two during the demonstration. Driver manifests are records kept by paratransit carriers listing information about each trip provided. Special manifests were developed prior to the demonstration for use by human service agencies. These trip records provide the only information available concerning the productivity of paratransit vehicles prior to the demonstration. During the demonstration, ACCESS required that all carriers in its network complete driver manifests on a continual basis.

In this subsection, we use driver manifest data to examine the vehicle productivity of paratransit providers before and after the demonstration. It is important to note that driver manifest data, recorded by taxi drivers, can be flawed. Many of the records are incomplete or inconsistent. For some types of data, drivers have little incentive to provide accurate answers. This is particularly true of information pertaining to driver performance, such as actual arrival time. Thus, driver manifest data must be interpreted cautiously; they provide only indications of broad trends. Although a great deal of information was collected through driver manifests, we present here only those data that appear to be valid representations of actual conditions.

The first sample of driver manifest records corresponds to trips taken in February and March, 1979. These trips were provided by the AS/AAA in their owned or leased vehicles and by Magic Carpet, prior to the demonstration. The second sample of records corresponds to trips provided by all ACCESS carriers in January 1981 during the demonstration. The last sample corresponds to ACCESS trips taken in December 1981, after the institution of the two-hour-in-advance reservation requirement. The time periods for these samples were chosen on the basis of weather conditions, as it was hypothesized that severe weather would influence vehicle productivity. Because total paratransit ridership has grown steadily, it was impossible to choose samples from periods of similar total demand. In assessing the observed patterns of vehicle productivity, we must be mindful of differences in total ridership and other factors.

In fact, the types of trips served in the "before" period (February and March 1979) are very different from those served by ACCESS carriers. First, the large majority of trips in the "before" sample are agency-sponsored. In the "after" samples (January and December 1981), agency trips constitute a

lesser percentage of all trips (62 and 35 percent, respectively). This difference in the type of trips served has significant implications for vehicle productivity. Agency-sponsored trips are often regularly-scheduled; non-agency-sponsored trips are often unique. Vehicle productivity should be higher, all other factors being equal, when more trips follow a regular schedule than when trip requests for one day are unrelated to the previous day's.

Furthermore, the non-agency trips served by ACCESS differ in other important ways from the agency-sponsored trips in the "before" sample. Seventeen percent of ACCESS trips in January 1981 and 29 percent of ACCESS trips in December 1981 required the use of a lift. Only slightly more than 1 percent of trips in the "before" sample required the use of a lift. In addition, the average distance of trips in the "after" sample was longer than the average distance of trips in the "before" sample. Because of these important differences in the types of trips recorded in the various sets of driver manifests, we would expect, all other factors being equal, that vehicle productivity would be lower in the "after" sample.

Two indicators of vehicle productivity have been calculated. The first is the number of passengers per vehicle tour. This is calculated as the average number of passengers served by a vehicle from the time one passenger enters the vehicle until the vehicle is again unoccupied; it is an indicator of the amount of ridesharing achieved. The second indicator of vehicle productivity is the average number of passenger trips per vehicle hour. This indicator is only available for ACCESS service. We can use it to chart productivity improvements during the course of the demonstration.

The average number of passengers per vehicle tour for ACCESS service is lower than that achieved by AAA and Magic Carpet vehicles prior to the demonstration, as shown in the chart below:

<u>Time Period</u>	<u>Average Number of Passengers Per Vehicle Tour</u>
February/March 1979 (not ACCESS)	1.92
January 1981 (ACCESS)	1.42
December 1981 (ACCESS)	1.71

These data indicate that the amount of ridesharing in the ACCESS system is less than that obtained by carriers before the demonstration. This decline is statistically significant at the .01 level of significance. As discussed above, this result is not surprising, given the important differences in the types of trips provided by the two systems, particularly the larger number of lift trips served by ACCESS. In addition, as explained below, service quality appears to be higher under the ACCESS system.

It is important to note in the above chart that ACCESS has improved its vehicle productivity over the course of the demonstration. The average number of passengers per vehicle tour has increased from January to December 1981. This increase is also statistically significant at the .01 level of significance.

Data on the average number of passenger trips per vehicle hour support these findings. As shown in Figure 4-7, ACCESS has been able to improve its utilization of dedicated vehicles on a fairly steady basis throughout the demonstration. There appears to be a lag between improved ridesharing and better vehicle utilization. For example, even though the amount of ridesharing increased during 1981, vehicle utilization improved slowly. During its first two years of operation, ACCESS stressed the importance of high-quality service to its carriers. Consequently, carriers may have been reluctant to reduce the vehicle hours they dedicated to ACCESS service until it was clear that service quality could be maintained. Another reason why ridesharing increased without a concomitant improvement in vehicle utilization is that ACCESS continued to serve a growing percentage of trips requiring lift-equipped vehicles. Even if ACCESS improved its scheduling and increased ridesharing, a larger share of lift trips would tend to decrease the number of passengers that could be served each hour. Thus, it appears that ACCESS has made steady productivity improvements in serving large numbers of ambulatory and nonambulatory passengers.

4.4.2 Service Quality

ACCESS seems to provide higher-quality service to its patrons than was provided before the demonstration. As shown in Table 4-5, a number of indicators of service quality have been calculated for three time periods. The first indicator, the average difference between actual and scheduled pickup time, is a measure of the timeliness of service delivery. Prior to the demonstration, drivers report that the average paratransit patron waited 4.9 minutes beyond scheduled arrival time for a vehicle. ACCESS drivers report that the average patron waited 3.8 minutes in January 1981. This on-time improvement is statistically significant at the 0.1 level, although there is a large variation in this on-time performance.

The second indicator of service quality shown in Table 4-5, trip circuitry, is a measure of the directness of the passenger's trip. With increased ridesharing, patrons may travel longer distances than the direct distance from their origins to their destinations. A trip circuitry index of 1 indicates that the passenger was taken directly from origin to destination. Lower indices indicate that the passenger traveled a more circuitous route. Under the ACCESS system, average trip circuitry was 0.88 (January 1981), compared to an average trip circuitry of 0.80 achieved by paratransit providers before the demonstration. This implies that ACCESS offers a higher service quality with respect to directness of trip.

PASSENGER
TRIPS PER
VEHICLE HOUR

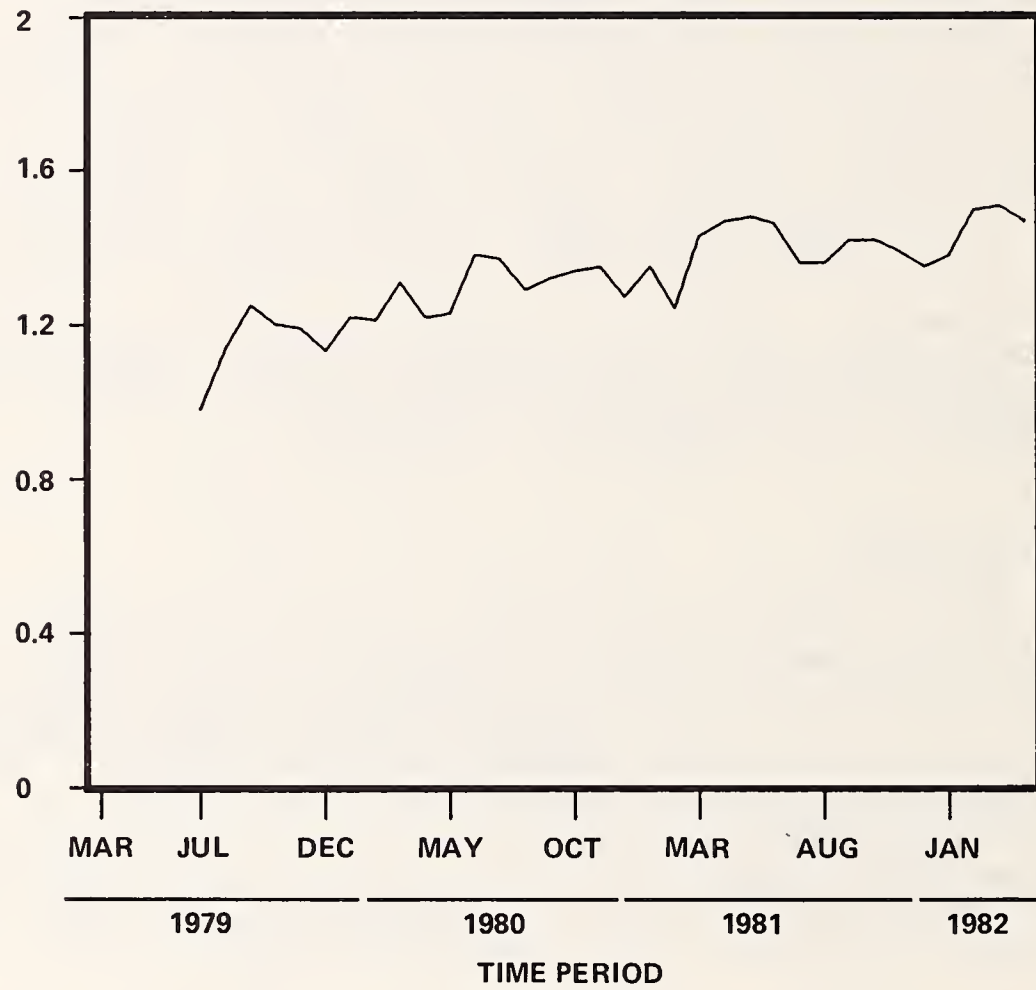

Figure 4-7. ACCESS PASSENGER TRIPS PER VEHICLE HOUR, BY MONTH

SOURCE: Access Operations Reports, Nos. 1-38.

TABLE 4-5. COMPARISON OF PARATRANSIT SERVICE QUALITY
FOR THREE TIME PERIODS

<u>Service Quality Indicator</u>	<u>February 1979</u>	<u>January 1981</u>	<u>December 1981</u>
Average Difference Between Actual and Scheduled Pick-up Time	4.9	3.8	3.9
Average Trip Circuity*	0.80	0.88	0.89
Average Passenger Trip Speed**	9.7	11.7	10.4
Average Difference Between Actual and Scheduled Pick-up Time -- Lift Used	N.A.	8.4	6.3
Average Difference Between Actual and Scheduled Pick-up Time -- Lift Not Used	4.9	2.8	2.6

*Trip Circuity is computed as the direct distance from a passenger's origin to destination divided by the total distance traveled by the passenger. A trip circuity index of 1.00 indicates that the passenger was taken directly from origin to destination. A lower index number reflects greater circuity.

**Passenger trip speed is computed as the distance to a passenger's destination divided by the time it took to get there.

NOTE: Because origin and destination information was not recorded for agency-sponsored trips, trip circuity and passenger speed data do not include information on agency-sponsored trips.

N.A. = Not Available, because sample size was too small.

SOURCE: ACCESS Driver Manifests for February/March 1979, January 1981, and December 1981; calculations by Charles River Associates, 1982.

Similarly, average passenger speed, defined as the distance to a passenger's destination divided by the passenger's travel time, is higher under the ACCESS system than for providers in the earlier periods. To a large extent, ACCESS achieves better average trip circuitry and speed because the broker produces a lower proportion of shared-ride trips than were produced in the "before" period. Unless ridesharing is accomplished by picking many passengers up at one origin and transporting them to one destination, it involves some deterioration in travel time and speed for the individual passenger.

We cannot compare the quality of lift services in the "before" and "after" samples, because our sample of lift trips in the "before" period was too small. This is indicative of the small number of lift trips provided before ACCESS was instituted. In comparing the service quality of ACCESS trips requiring the use of a lift to that of ACCESS trips which do not, we find that passengers requiring lifts must wait longer for a vehicle to arrive than ambulatory or semi-ambulatory passengers. As shown in Table 4-5, the average wait beyond scheduled arrival time for ACCESS lift passengers in January 1981 was 8.4 minutes, compared to 2.8 minutes for non-lift passengers. By December 1981, the broker had reduced this gap significantly; average waiting time for lift trips decreased to 6.3 minutes, versus 2.6 minutes for non-lift trips. It is interesting to note that ACCESS also increased the number of shared rides served over the same period, a factor that might have negatively affected on-time performance. Instead, on-time performance improved.

In sum, service quality under the ACCESS system, as measured by on-time performance and directness of trip, appears to be higher than the quality of service offered prior to the demonstration. Of course, a number of other factors are also important determinants of service quality, including driver sensitivity, ease of scheduling trips, and the like. These issues are examined in Section 5 from the point of view of human service agencies purchasing ACCESS service, and in Section 6 from the point of view of individual users.

4.4.3. ACCESS Transportation Costs

The driver manifest analysis described above suggests that during its period of operation, ACCESS has made gradual improvements in the productivity of its vehicles and in the quality of service it provides. This improvement occurred, furthermore, while the broker was engaged in providing a steadily increasing number of trips. In this subsection, we explore the level and pattern of ACCESS' transportation costs during the demonstration to see how ACCESS service improvements affected the cost of service.

Table 4-6 lists the average number of ACCESS monthly trips and average transportation, administrative, and total costs for three fiscal periods. In the first row, we can see that the average number of monthly trips provided

TABLE 4-6. AVERAGE ACCESS MONTHLY TRIPS, TRANSPORTATION COSTS, ADMINISTRATIVE COSTS, AND TOTAL COSTS, BY FISCAL PERIOD

	Fiscal Period*		
	1980	1981	1982
Average Number of Monthly Trips**	6,343	14,383	18,212
Average Transportation Cost Per Trip (in Current Dollars)	\$ 8.87	\$ 8.92	\$ 8.84
Average Administrative Cost Per Trip (in Current Dollars)	3.71	1.84	1.51
Average Total Cost Per Trip (in Current Dollars)	12.58	10.76	10.35
Average Total Cost Per Trip (in 1980 Dollars)***	12.58	8.44	7.20

*Fiscal periods are from July 1 to June 30.

**Includes non-paying escorts.

***Figures deflated to January 1980 using the public transportation component of the Consumer Price Index.

SOURCE: ACCESS Operations Reports, Nos. 28 and 40; calculations by Charles River Associates.

by the broker increased each period, rising from an average of 6,343 in 1980 to 18,212 in 1982. (These ridership figures include non-paying escorts.) With this growth, the average transportation cost per trip changed very little, as shown in the second row. The average transportation cost per trip in the 1980 fiscal period was \$8.87, \$8.92 in 1981, and \$8.84 in 1982 (all in current dollars).

In contrast to the stable character of transportation costs, ACCESS' administrative costs per trip, shown in the third row of Table 4-6, dropped significantly between the 1980 and 1982 periods. Because of start-up expenses, the average administrative cost per trip was \$3.71 in fiscal period 1980. These costs dropped to an average of \$1.84 in 1981 and \$1.51 in 1982.

With the decline in administrative costs, the average total cost of an ACCESS trip declined during the demonstration. When measured in current dollars, the average total cost per trip was \$12.58 in fiscal period 1980, \$10.76 in 1981, and \$10.35 in 1982. By accounting for the effect of inflation in this way, the decline in total transportation costs becomes more pronounced. The last row of Table 4-6 shows the average total cost per trip deflated to 1980 dollars through the use of the Consumer Price Index. With this adjustment, we see that in real terms, ACCESS' average total cost per trip was \$12.58 in fiscal period 1980, \$8.44 in 1981, and \$7.20 in 1982. By holding the line on transportation costs and decreasing its administrative costs, ACCESS was able to make steady improvements in per trips costs over the course of the demonstration.

5. IMPACT OF THE DEMONSTRATION ON HUMAN SERVICE AGENCIES

This section describes the impacts of the demonstration on Allegheny County human service agencies. It is divided into four subsections. First, we discuss the objectives of the demonstration with regard to human service agencies. Second, we describe the activities of the broker, ACCESS, in marketing its services to human service agencies. Third, we explore the use of ACCESS services by agencies and the attitudes and opinions of agency managers about coordination. The information presented in this section is drawn from personal interviews with agency managers and a mail survey of all Allegheny County agencies, both of which were undertaken as part of the demonstration evaluation. Finally, we summarize the effects of the demonstration on human service agencies.

5.1 DESIRED IMPACTS OF COORDINATION

An important objective of the Pittsburgh Paratransit Brokerage Demonstration was the coordination of transportation resources for the elderly and handicapped supplied by human service agencies with resources provided by private and public sources. The demonstration was designed to coordinate transportation resources in two ways. First, the services of some agencies that provide transportation were consolidated into a unified service delivery network with for-profit providers. Second, trip requests by agencies that purchase transportation were pooled with the trip requests of unaffiliated individuals and individuals eligible for the Port Authority's user-side subsidy. This section focuses on the coordination of agencies that purchase transportation.

Coordination was expected to produce a number of benefits for the overall system and for the agencies themselves. First, the coordination of agency providers with for-profit providers was expected to improve the utilization of agency vehicles. Prior to the demonstration, many agency vehicles were used to serve client medical trips, some of which tied vehicles up for long periods of time while serving only one trip. If these trips could be served by vehicles from other sources, it was hoped that the overall productivity of paratransit vehicles would increase. Second, coordination of human service agency trip requests with other trip requests was expected to lead to increased ridesharing. Similar to improved vehicle utilization, it was thought that increased ridesharing would reduce the cost of producing paratransit trips. These cost savings could be spread across all transportation purchasers.

These cost reductions were expected to be realized without a reduction in service quality. In fact, service quality was expected to increase, because of both the sensitivity training program for taxi and van drivers and raised carrier insurance coverage. The broker was also designed to provide a number of ancillary services for agencies. These functions include third-party billing services, direct interface with carriers, and improved complaint procedures. Together with cost savings, these ancillary services were expected to outweigh the administrative costs of the broker that ultimately would be borne by human service agencies.

5.2 MARKETING ACCESS SERVICE TO AGENCIES

Early marketing efforts for ACCESS services focused on the largest agencies in Allegheny County. Discussions concentrated on the four major funding sources for elderly and handicapped paratransit in the county: 1) the Allegheny County Adult Services/Area Agency on Aging (AAA); 2) the Allegheny County Mental Health/Mental Retardation Drug and Alcohol Program (MH/MR); 3) the County Board of Public Assistance (BPA); and 4) the Bureau of Vocational Rehabilitation (BVR). As the AAA provides funding for approximately 70 percent of all subsidized trips by elderly and handicapped persons in the county, its participation was deemed critical to the success of ACCESS. Without the AAA, it was believed, it would be impossible to generate a large enough volume of trips for high levels of ridesharing.

Despite efforts by ACCESS and the Port Authority to interest the AAA in participating in ACCESS, the AAA refused to purchase service from ACCESS until mid-1980. Because significant savings from increased ridesharing were expected, ACCESS offered to provide transportation for the AAA at a rate below what the latter then paid to carriers directly. The offer of reduced transportation costs did not result in participation by the AAA, however. The AAA maintained that high service quality was important to the agency, and it appears that ACCESS, which had been in existence for a limited period, represented a risk for the AAA in terms of service quality. One particular concern of AAA management was that their elderly clients would be inconvenienced by sharing rides with handicapped persons.

After extensive discussions between the AAA and ACCESS, AAA management agreed to a trial period of ACCESS usage by their clients in October 1979. The trial was evaluated by a review of carrier manifests to determine changes in productivity, and by circulation of a rider survey to measure changes in AAA client satisfaction. During the trial period, ridesharing by AAA clients increased significantly, but only a small fraction of these elderly persons shared rides with handicapped persons. No significant change in clients' satisfaction with their transportation services was detected. The limited ridesharing between the two groups was believed to be due mainly to the carriers' reluctance to alter standing trip scheduling practices (with ACCESS and AAA trips scheduled separately). Carrier productivity, measured as the

number of passengers per billable vehicle hour, changed little during the course of the trial period. An interesting finding of the manifest review, however, was that use of separate carrier manifests for AAA and ACCESS trips, coupled with the lack of a central control to monitor the manifests, resulted in as much as a 9 percent overbilling by carriers to both the AAA and ACCESS. Carriers were in some cases charging both organizations for vehicle deadheading. This overbilling appears to have occurred prior to as well as during the trial period.

Despite the findings of the trial period and the possibility of continued overbilling by carriers, the AAA did not immediately join ACCESS. A change in the county administration, however, seems to have prompted the AAA to consider ACCESS more favorably as a transportation provider. (The AAA is a county agency.) After continued marketing and discussions between the AAA, the Port Authority, and ACCESS, the AAA began to purchase service through ACCESS in June 1980. Many of the AAA's satellite centers continued to provide transportation to AAA clients, including two centers that had acted as not-for-profit ACCESS carriers since 1979.

ACCESS has marketed its services to other agencies in a straightforward yet low-key manner. ACCESS management visited the larger agencies to explain and discuss the broker's service features. Besides the AAA, the other three large agencies have participated in ACCESS to some extent since the broker was instituted. Four of six MH/MR-affiliated agencies purchase service through ACCESS, as does the BVR, and the BPA reimburses nonambulatory clients who purchase service through ACCESS.

Other agencies were sent a letter, highlighting ACCESS service and its operational processes. (See Appendix C for promotional materials sent to agencies.) These marketing efforts produced agreements with the following numbers of agencies to participate in the purchase of service through ACCESS at any given time, with the AAA counted as one agency:*

<u>Year</u>	<u>Approximate Number of Agencies Participating</u>
1979	24
1980	35
1981	38
1982 (through May)	22

*Counting the AAA agencies separately, by May 1982 ACCESS served 42 agencies actively.

Many agencies that had set up third-party billing arrangements with ACCESS never used their accounts. Accounts for these agencies are now considered inactive, and ACCESS no longer counts them among participating agencies. Accounts were designated inactive in 1982, which explains the large drop in the number of agencies participating between 1981 and 1982. Apart from inactive accounts, nine agencies obtained third-party billing arrangements and subsequently stopped purchasing service through ACCESS.

5.3 COST OF ACCESS SERVICE TO THE AAA

An important element in an agency's decision to use a coordinated transportation system like ACCESS is the cost of service. An agency wants to know if coordination of its trips with those of other agencies will produce cost savings. Such cost savings may not be restricted to the agency's transportation bills -- they may appear as decreased transportation management effort by the agency or as improved service quality for agency clients.

The many ways in which cost savings (or increases) can appear complicates our investigation of changes in the cost of transportation services for Allegheny County agencies as a result of joining ACCESS. In comparing ACCESS' rates and the rates of carriers used by agencies before ACCESS, we are unable to control adequately for changes in the characteristics of trips provided before and during the demonstration. It is difficult to control for changes in service quality and the non-budgetary expenses of agencies (e.g., some types of management effort, volunteer drivers).

An additional difficulty in comparing the transportation costs of the agencies across time periods is the paucity of data on the cost of service prior to the demonstration. While information on total agency payments to outside carriers is available, records of the number of trips provided by these carriers are often inaccurate. Agency records typically contain information on trips scheduled, not trips actually taken. This recordkeeping makes it difficult to obtain accurate data on per-trip agency costs prior to the demonstration.

With these difficulties in mind, we focus here on the cost of transportation services for one agency, the AAA. An examination of the AAA's transportation costs is informative for several reasons. First, the AAA contracted with private carriers before contracting with ACCESS. In fact, during 1979 the AAA contracted with private carriers for dedicated vehicle service at a time when ACCESS also was contracting with these carriers for service. Second, the AAA has been a steady and very important account for ACCESS. We can examine the rate charged by ACCESS to the AAA during the period 1981-1984, assessing the progress made by ACCESS in reducing its own rates. Finally, because the AAA has always had a large transportation

program, we can consider the likely impact of ACCESS on the quality of service received by the agency. In areas such as management effort, geographic coverage and service hours, we can detect ways in which ACCESS has affected the agency's achievement of its service mission.

As noted earlier, the AAA is the largest human service agency sponsor of transportation in Allegheny County. Its mission is to provide a variety of services, including transportation, to individuals over 60 years of age throughout the county. The AAA both purchases transportation services and provides it directly in vehicles operated by its satellite centers. The AAA generally contracts with private carriers for medical trips only. Its centers provide transportation for other purposes, particularly group nutrition trips. The AAA began to purchase service for medical trips from ACCESS in June 1980. AAA centers continued to provide additional service for medical purposes until June 1982, at which time AAA management decided to use ACCESS as its exclusive provider of medical trips.

Our examination of the cost of ACCESS service to the AAA begins with a review of the rates charged by carriers to both organizations. Prior to joining ACCESS, the AAA purchased service from private carriers on a dedicated vehicle basis. Similar to ACCESS' purchase of dedicated vehicle service, the AAA was in effect buying the use of a vehicle from the time it left a carrier's garage until its return. Three carriers that provided dedicated vehicle service to the AAA were Yellow Cab, Colonial Taxi and Paratransit, and North Hills Transportation.

In 1979, ACCESS began to purchase dedicated vehicle service from two of these carriers. The rates negotiated by ACCESS with Colonial Taxi were the same as those negotiated by the AAA. The Yellow Cab Co., however, charged ACCESS \$10.50 per hour of dedicated vehicle service versus \$10.00 per hour charged to the AAA. Yellow Cab justified this rate as a consequence of ACCESS' high carrier insurance requirements. Also, ACCESS negotiated its rate with Yellow Cab later in the year than did the AAA. At the time, the ACCESS manager was assured that parity would be achieved during the next round of contracting with the AAA. (Because the AAA subsequently decided to use ACCESS for its purchased medical transportation, this next round of contracting never took place.)

This evidence suggests that ACCESS was able to purchase service for its users at a somewhat higher rate than that available to the AAA. With the SMD grant providing funding for administrative expenses and more attractive service features, ACCESS was able to effectively compete with private carriers for agency contracts on a cost basis. This was of considerable advantage to smaller agencies, which were unable to obtain the favorable rates quoted by carriers to large purchasers such as the AAA. It is important to keep in mind, however, that ACCESS and the private carriers were not truly in competition because ACCESS used the carriers to provide its trips.

Table 5-1 lists the rates charged by ACCESS to the AAA from June 1980 to June 1985. When the AAA originally began to purchase service through ACCESS, it wanted to give ACCESS its transportation budget and be assured that its transportation needs would be met. This arrangement was unacceptable to ACCESS; a compromise of charging the AAA a flat rate per trip was devised. ACCESS used driver manifest data from the AAA's trial period of ACCESS usage in October 1979 to calculate average trip length and average unit cost, and the broker used these figures to negotiate a flat rate with the AAA. The sample of trips used had been drawn exclusively from medical trips the AAA purchased from private carriers; it did not include medical trips then served by AAA centers in agency vehicles. To protect its budget, the AAA included in its contract with ACCESS a clause allowing the AAA to stop purchasing service if the total amount spent approached its annual amount set aside for transportation.

Soon after the AAA began to use ACCESS service, it became apparent that the trips ACCESS was serving differed in character from those ACCESS had used to calculate a unit cost. The trips requested by the AAA were longer on average than those ACCESS had served in the trial period. ACCESS had set a per-trip rate of \$7.04 for service to the AAA but it was costing approximately \$8.00 per trip in transportation costs alone to provide these trips. The productivity, and per-trip cost reductions, expected from AAA participation in the ACCESS network were not appearing as quickly as anticipated.

In January 1981, ACCESS and the AAA moved to a contract involving a pass-through cost arrangement. ACCESS staff began to review carrier records and allocate charges to AAA-sponsored trips. The AAA was essentially charged only for its direct transportation costs. This pass-through procedure can be viewed as a means of protecting the broker because shifting AAA trip demands made it difficult to calculate a flat rate. The administrative demands of the arrangement were staggering, however, and they ultimately forced the broker to develop a method of calculating a flat rate for service. As shown in Table 5-1, the average cost to the AAA during this period of pass-through charges was approximately \$10.50 per trip. As before, the SMD grant covered administrative expenses and this rate was intended to cover transportation costs only.

In July 1982, ACCESS began to charge the AAA at a flat rate of \$13.50 per trip. This rate was intended to cover the fully-allocated cost of providing service to the AAA, the demonstration having concluded in June 1982. In retrospect, ACCESS management believes the rate set may have been too high, but there were several reasons why this rate was negotiated. First, the broker previously had failed to cover its transportation costs under a flat-rate arrangement with the AAA. ACCESS wanted to reduce the risk of this situation reoccurring. Without the SMD grant, the Port Authority would be forced to fund the deficit. ACCESS feared the possibility of a deficit not only because it would be contractually committed to a flat rate for service, but also because of several changes in its service network. In

TABLE 5-1. ACCESS RATES FOR SERVICE TO THE AAA

<u>Time Period</u>	<u>AAA Cost Per Trip in Current Dollars</u>	<u>AAA Cost Per Trip in 1980 Dollars*</u>
June 1980 - December 1980	7.04	6.77
January 1981 - June 1982**	10.50	8.03
July 1982 - June 1983	13.50	9.55
July 1983 - December 1983	12.35	8.48
January 1984 - June 1984	12.55	8.37
July 1984 - June 1985	12.25	N.A.

*Figures deflated to January 1980 from the midpoint of the period using the public transportation component of the Consumer Price Index for all urban consumers.

**During this period ACCESS charged the AAA on a pass-through basis. This figure is an estimate of the average per-trip rate actually paid by the AAA.

N.A. = Not Available.

SOURCE: Cost figures in current dollars provided by ACCESS. Other calculations by Charles River Associates, 1984.

June 1982, the AAA decided to use ACCESS as its exclusive provider of medical trips. This decision, while welcomed by ACCESS, added a large element of uncertainty to its existing vehicle schedules. Furthermore, ACCESS management anticipated higher cost bids by carriers during the January 1983 contracting round.

The second reason why a rate of \$13.50 was negotiated involves the AAA. Because of a new state subsidy program, the AAA was probably less cost conscious than it had been previously. At the time that the \$13.50 rate took effect, the state-funded 65 Plus Program was initiated in Allegheny County, with ACCESS one of the first certified providers. With this program, the AAA paid only \$3.40 of the \$13.50 per trip when ACCESS served one of its clients aged 65 years or older. As the AAA is an agency that exclusively serves the elderly, the majority of its clients qualify for the 65 Plus subsidy.

Despite the presence of the 65 Plus program, ACCESS reduced its per-trip rate for AAA trips in July 1983. By that time it was clear that ACCESS could serve AAA trips at a rate lower than \$13.50. Carrier cost increases had been restrained by the continued influence of competing carriers and ACCESS' per-trip administrative costs continued to decline. Furthermore, contrary to previous fears, the new AAA medical trips resulted in improved dedicated vehicle productivity for ACCESS carriers, as many trips could be incorporated into existing vehicle schedules. Consequently, in July 1983 the rate charged to the AAA was reduced from \$13.50 to \$12.35 per trip.

The next round of AAA-ACCESS contracting took effect in January 1984. Because of increased carrier cost bids, the nominal per-trip rate rose to \$12.55. As can be seen from the second column of Table 5-1, when we adjust these rates for the effects of price inflation, the new rate of \$12.55 per trip represents a decline in real terms. This trend continued into the next contract period, with a per-trip rate of \$12.25 negotiated for the July 1984-June 1985 period. Both in nominal and real terms, this is a decline in the cost of service to the AAA.

In summary, from the limited perspective of per-trip rates only, the relationship between the AAA and ACCESS required a considerably long shaking-out period. During this time the broker and the agency sought to arrive at a fair rate that allowed for some risk-sharing by each side. By July 1982, two years after the start of ACCESS service to the AAA, this process was completed. Since that date, ACCESS has made steady progress in reducing the cost of service to the AAA.

It is important to consider also the qualitative changes in transportation services brought about by the AAA's decision to use ACCESS. As described in Section 4.4.2, ACCESS enhanced the quality of service to agencies in several significant ways. Service hours were made available to agencies from 6 a.m. through midnight, six days per week. Wheelchair service became available on a regular basis and drivers were required to provide door-to-door service. Carriers were required to maintain higher insurance

coverage and to comply with ACCESS vehicle specifications. Each of these changes represents an enhancement of the service offered by private carriers to agencies, including the AAA, outside the ACCESS network.

A particularly important change from the AAA's perspective was the expansion of paratransit service through ACCESS to all areas of Allegheny County. The AAA has a mandate to serve all elderly persons within the county. Yet, prior to ACCESS, the AAA relied on three carriers and its centers to cover these 728 square miles. ACCESS has been able to incorporate 12 carriers into its network (as of June 1984) and has made wheelchair service available to agencies on request. These resources have altered over time the mix of medical trips requested by the AAA. Gradually, there has been an increased demand for service by AAA clients in remote sections of the county, especially the northwestern corner. Furthermore, the proportion of trips by AAA clients using wheelchairs also has increased over time. These developments suggest that ACCESS has gradually aided the AAA in fulfilling its agency mandate.

Participation in the ACCESS network has allowed the AAA to reduce some of the effort it formerly expended on management of its transportation programs. ACCESS appointed a senior staff person, the assistant manager, to handle service complaints from AAA clients and to monitor carrier records. This effort by ACCESS allowed the AAA to reduce its staff by one half-time position.

ACCESS also has provided assistance to the AAA in client and staff education. The broker produces brochures and other materials for distribution to AAA clients, detailing how to use the system. ACCESS staff, moreover, meet with AAA staff in an effort to streamline service request intakes by agency personnel and to allow for overall improvements in trip scheduling. ACCESS staff have worked with AAA and carrier staff to improve the flow of information between these two parties.

The ACCESS manager has provided assistance to the AAA planning staff in responding to special needs of the agency. Meetings between the two parties are held twice or three times each year, at which time ACCESS describes new service developments and the AAA staff discusses their planned service requirements. An important outcome of these meetings is the senior day-care program, in which elderly persons requiring special care are transported to and from an AAA center. These clients typically have serious medical problems and they must be transported carefully. They cannot remain on-board a vehicle for long periods of time and they need special attention from vehicle drivers. ACCESS worked closely with the AAA in developing this transportation program and the broker continues to carefully monitor carrier performance. Three AAA centers operated senior day-care programs by mid-1984 and three additional programs are planned to begin by the end of 1984.

The decision by the AAA to participate in the ACCESS network was undoubtedly a complicated one. As we have seen, the changes wrought by ACCESS' service of AAA trips goes beyond simple changes in the cost per trip. ACCESS has, over time, made good progress in reducing the per-trip cost of service but it has also altered substantially the delivery of paratransit services in the county. These changes appear to have been beneficial to the AAA.

In the following sections we look more closely at the community of human service agencies in Allegheny County and their transportation programs. Through the use of a survey of agency managers, we explore the opinions and attitudes of these managers on the benefits of ACCESS to their agencies.

5.4 AGENCIES' USE OF AND ATTITUDES TOWARD ACCESS SERVICE

To determine the use of ACCESS service by human service agencies, two types of data collection activity were undertaken for the demonstration evaluation. First, personal interviews were held with a small sample of agencies before and after the brokerage implementation in February 1979 and November 1980. Second, a survey was mailed to all Allegheny County human service agencies serving the elderly and/or handicapped in May 1982. This survey provides comprehensive data on the transportation programs of human service agencies.

Much of the information provided in this section of the report is drawn from the survey of human service agencies. Three types of agencies were canvassed: agencies that purchase service through ACCESS (termed ACCESS-affiliated); agencies that did purchase service from ACCESS at one time but no longer do (formerly-affiliated); and agencies that have never purchased service through ACCESS (non-affiliated). The number of surveys mailed to each type of agency and the number of agencies responding are listed below.

<u>Type of Agency</u>	<u>Number of Surveys Mailed</u>	<u>Number of Surveys Completed</u>	<u>Response Rate(%)</u>
ACCESS-Affiliated	42	35	83
Formerly-Affiliated	9	3	33
Non-Affiliated	65	50	77
All Agencies	<u>116</u>	<u>88</u>	<u>76</u>

The survey was intended to represent a 100 percent sample; that is, every human service agency identified as serving the elderly and/or handicapped was mailed a survey. Because the number of formerly-affiliated agencies completing the survey was low, information from the survey cannot be considered an adequate representation of formerly-affiliated agencies.

5.4.1 Human Service Agencies and Their Transportation Programs

ACCESS has identified 116 human service agencies that serve elderly and/or handicapped individuals. A key feature of this agency community is its diversity. The agencies differ greatly in structure, funding sources, and client base. Because of these differences and variations in their desire to provide transportation services, the agencies have developed a complex network of transportation resources to meet their needs.

The organizational structure of the agencies and their funding sources are closely tied. As shown in Table 5-2, the majority of agencies are private, not-for-profit organizations. These private organizations rely most heavily for funding on product and service sales, followed by user fees and contributions. These sources place few restrictions on an agency's decisions regarding the choice of a transportation provider. One important exception to this observation, however, is the group of agencies receiving fundings through the AAA. As noted above, many transportation decisions for AAA-affiliated agencies are made at the county level.

A smaller percentage of agencies are private, for-profit organizations. This group of agencies is composed primarily of nursing homes and hospitals. They receive funding for their activities from third-party payments and from user fees. Typically, these agencies purchase transportation service only when it is needed to transport a client directly to or from an agency's primary facility. The client is generally charged the full cost of such services. On rare occasions, a vehicle may be requested for a group trip.

Another small percentage of agencies are public agencies, including the Veterans Administration Hospital. The primary funding of these agencies is provided by county-administered, Federally-sponsored programs. These agencies are subject to varying restrictions on their provision of transportation, depending on the requirements of their specific funding source.

The total number of clients served by each agency also varies substantially. The median number of clients served is approximately 350 clients, with 5 agencies serving over 9,000 clients each. On average, the agencies serve only about 60 percent of their clients each week.

TABLE 5-2. ORGANIZATIONAL STRUCTURE
OF ALLEGHENY COUNTY HUMAN SERVICE AGENCIES

<u>Organizational Structure</u>	<u>Percentage of Agencies</u>
Private, Not-For-Profit	73
Private, For Profit	12
Public	10
Other	<u>5</u>
All Agencies	100

SOURCE: Human Service Agency Surveys, May 1982; calculations by Charles River Associates.

The transportation needs of agency clients appear to be substantial, as 90 percent of all agencies provide some type of transportation for their clients. Agencies provide trips for a variety of purposes, with medical trips, trips to social outings and events, and shopping trips being the most common transportation services provided. Seventy-six of the agencies schedule these trips on an advance reservation basis, with the majority requiring 24-hour advance notification by the client.

As shown in Figure 5-1, agencies sponsor transportation for their clients primarily on weekdays. The agencies sponsor or provide large volumes of trips between 7:00 a.m. and 5:00 p.m., and only a negligible amount at other times of the day. This pattern of demand indicates that many vehicles are required to fulfill human service agencies' trip requests, but this capacity is utilized mainly during weekday business hours.

To meet this pattern of demand, the agencies have devised a complex network of transportation services, in which ACCESS plays an important role. Agencies may choose to provide service in agency owned or operated vehicles, by volunteers using their own vehicles, from private carriers directly, or through ACCESS. Many agencies find it beneficial to use a combination of these resources.

Forty-eight percent of the agencies provide transportation in vehicles either owned or operated by the agency itself. The 88 agencies that responded to the demonstration evaluation survey own or operate a total of 293 vehicles. Of this total, 24 vehicles are operated by four agencies that also serve as ACCESS carriers. Ten agencies own or operate more than four vehicles, including five agencies owning or operating more than 20 vehicles. The majority of agencies, however, operate two or fewer vehicles, and almost half of all agency vehicles are ordinary sedans. Many agencies indicate that these sedans are used for general agency business as well as client transportation. Of the 293 vehicles identified in our survey, only 29 vehicles were reported as ramp or lift equipped.

As shown in Table 5-3, agencies receive funding to purchase vehicles from many sources, but more agencies have purchased vehicles using general agency funds than any other sources. Only 6 percent of the agencies that responded indicated that they had received vehicles under the Federal 16(b)(2) program.

Some agencies purchase transportation through ACCESS and some purchase service directly from carriers that also serve ACCESS trips. (In the next section, we compare the characteristics of agencies that use ACCESS with those that do not.) Agencies have a variety of arrangements with these carriers. Some agencies pay a predetermined rate for service, some pay the metered rate, and some are charged an hourly rate for service. No one type of arrangement appears to be the most popular.

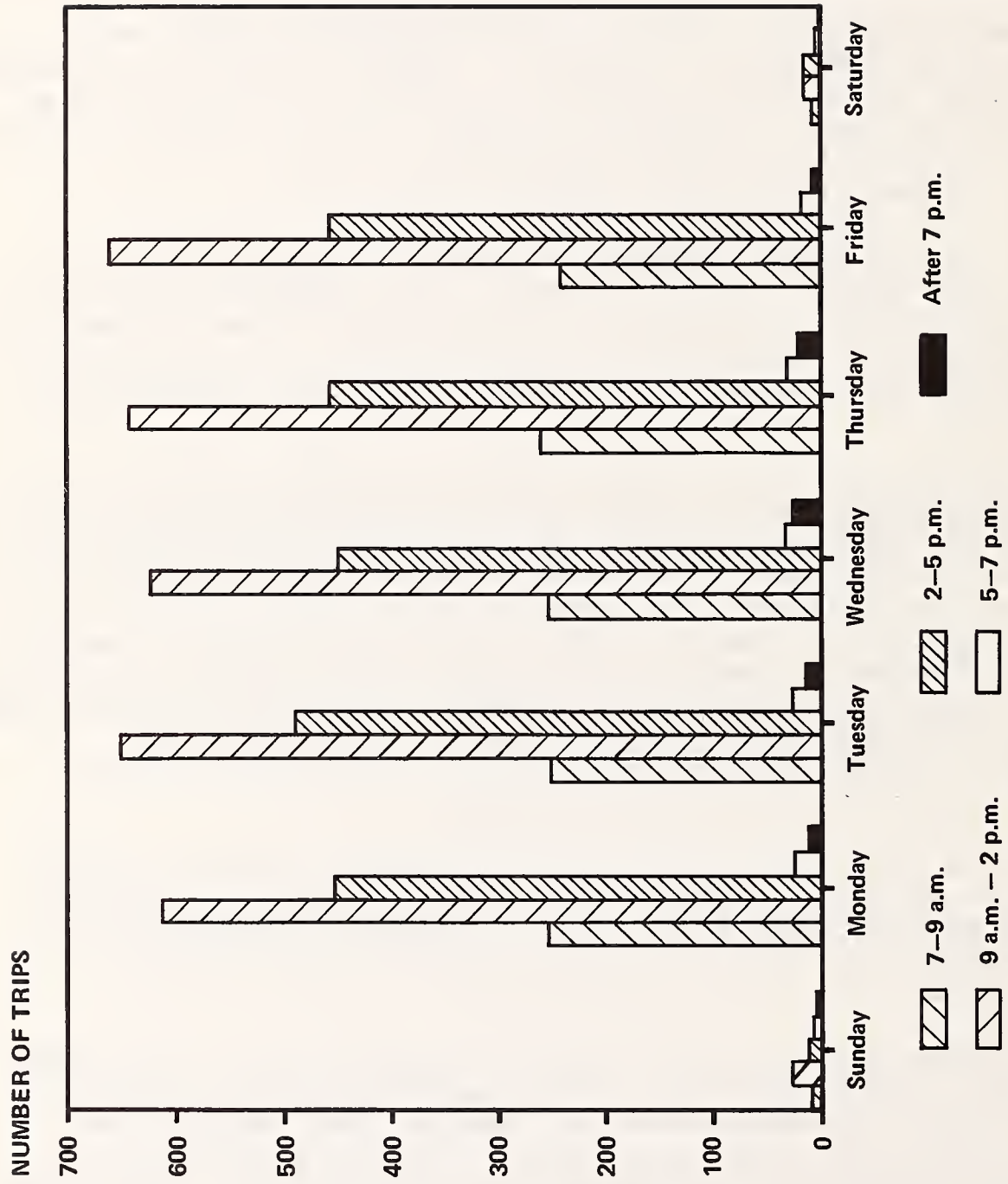

NOTE: For agencies responding to survey only. 88 of 116 Allegheny County agencies responded.

Figure 5-1. TOTAL AGENCY-SPONSORED PASSENGER TRIPS BY TIME PERIOD AND DAY OF WEEK

SOURCE: Human Service Agencies, May 1982; calculations by CRA.

TABLE 5-3. PERCENTAGE OF AGENCIES,
BY USE OF VEHICLE FUNDING SOURCE

<u>Vehicle Funding Source</u>	<u>Percentage of Agencies That Have Received Funds Through Source*</u>
16(b)(2) Grants	6
General Agency Funds**	25
State Funds	8
County Funds	7
Local Funds	4
Other Sources	19

*Column does not sum to 100 percent because not all agencies have received vehicle funding, and some agencies have received funding from multiple sources.

**Includes all funds received by the agency for its operation, except those specifically marked for vehicle purchase.

SOURCE: Human Service Agency Surveys, May 1982; calculations by Charles River Associates.

On average, agencies spend 5.5 percent of their budgets on transportation services. The median agency transportation budget in 1981 was \$6,000. A number of agencies spent a great deal more on transportation for their clients, however. Five spent over \$100,000 on transportation services and the AAA as a whole (i.e., including all 21 AAA agencies) spent \$776,476 on transportation in 1981. Agencies reported an average expenditure of \$8.73 per trip, but of the 88 agencies responding to the survey, only 22 indicated the average cost of their transportation services. Thus, this figure may not be an accurate representation of the cost of service to all agencies.

Despite the extensive transportation resources available to agencies, 47 percent of those surveyed indicated that they were unable to serve all of their clients' requests for transportation assistance. The agencies attributed this to limitations on the resources available to them to provide transportation. Agencies that rely on volunteers to provide transportation are more likely than others to be unable to provide service to all clients that request it.

5.4.2 Characteristics of ACCESS-Affiliated Agencies and Their Use of the ACCESS System

Of the 116 human service agencies that serve the elderly and/or handicapped, 42 purchase service through ACCESS. Of these 42 agencies, 21 are sponsored by the AAA. The AAA makes the transportation purchasing decisions for the agencies it sponsors. The remaining agencies have direct control over their transportation purchasing decisions.

The human service agency survey provides some indication of the differences between agencies that use ACCESS and those that do not. It is important to note, however, that the survey does not allow us to test hypotheses about the causal factors underlying an agency's decision to use ACCESS or not. These decisions depend on a number of factors, including economic factors, the specifics of the agency's transportation program, ACCESS' behavior toward the agency, and a variety of attitudinal and political factors. While the survey does not provide enough data to control for all these factors, it can be used to determine if hypotheses about an agency's use of ACCESS are consistent with the available evidence. This is the approach we have taken in the following paragraphs.

Table 5-4 provides information on the use of ACCESS by agencies serving various client groups. It can be seen that of those agencies serving elderly clients, 47 percent are affiliated with ACCESS. Thirty-four percent of agencies serving the physically handicapped and 32 percent of those serving the mentally handicapped use ACCESS. As a group, ACCESS-affiliated agencies spend more on transportation than do non-affiliated agencies. Thus, while the percentage of agencies that do not use ACCESS is greater than the percentage of agencies that do, agencies affiliated with ACCESS control a larger portion of total agency transportation resources (other than those provided by unpaid volunteers).

TABLE 5-4. PERCENTAGE OF AGENCIES SERVING VARIOUS CLIENT GROUPS, BY AFFILIATION WITH ACCESS

<u>Client Group</u>	<u>Percentage of Agencies Serving Groups That Use ACCESS</u>	<u>Percentage of Agencies Serving Groups That Do Not Use ACCESS</u>	<u>Total</u>
Elderly	47	53	100
Physically Handicapped	34	66	100
Mentally Handicapped	32	68	100
Other Groups	41	59	100

Note: Many agencies serve more than one client group.

SOURCE: Human Service Agency Surveys, May 1982; calculations by Charles River Associates.

Table 5-5, which details the transportation arrangements used by ACCESS-affiliated and non-affiliated agencies, provides additional insights into the differences between the two. A larger percentage of ACCESS-affiliated agencies operate agency vehicles than do non-affiliated agencies, and a larger percentage of ACCESS-affiliated agencies purchase transportation services than do those not affiliated with ACCESS. In contrast, a larger percentage of non-affiliated agencies use volunteers or staff who drive their own vehicles to provide transportation for their clients.

Agencies' responses to questions about why they do or do not use ACCESS support the notion that some agencies have transportation demands that are better met by systems other than ACCESS. First, many non-affiliated agencies schedule trips for their clients without an advance reservation requirement. ACCESS, which requires a one-day-in-advance reservation for agency-sponsored trips, does not meet the needs of these agencies. Second, many non-affiliated agencies provide only limited amounts of service, such as taxi service to or from a nursing home. These services are often billed directly to clients. Agencies providing such service have little incentive to set up a third-party billing system with ACCESS, as the benefits for the agency are unlikely to warrant the effort of doing so. Third, non-affiliated agencies that provide transportation on a regular basis are able to supply a large number of agency trips using agency vehicles or volunteers, and they prefer to supplement these arrangements with purchased taxi service. Many of these agencies believe it is less expensive for them to purchase supplemental transportation directly, rather than through ACCESS. Non-affiliated agencies that do purchase transportation services purchase only small amounts on average. Typical purchased services include ambulance service, hiring a van for a unique group trip, or hiring school bus service on a regular basis.

On average, ACCESS agencies own or operate fewer vehicles than do non-affiliated agencies. An important reason why ACCESS-affiliated agencies provide more transportation for their clients but own or operate fewer agency vehicles is suggested by the way these agencies use the broker. An examination of the services ACCESS-affiliated agencies use to provide various types of trips indicates that these agencies use the broker instead of agency vehicles for single-passenger trips. Table 5-6 lists the purposes for which ACCESS-affiliated agencies provide transportation by various types of service. Specific patterns of usage can be discerned. Although 47 percent of all ACCESS-affiliated agencies provide trips to group-meal sites, only 3 percent use ACCESS to provide the service. Similarly, while 67 percent of ACCESS-affiliated agencies provide group social trips, only 22 percent use the broker for this purpose. Agencies are more likely to provide these trips, which are usually group trips, using agency vehicles.

In contrast, 86 percent of ACCESS-affiliated agencies provide medical-related trips and 75 percent use ACCESS for this purpose. Medical trips are often long-distance and not pre-arranged into group trips. Scheduling return trips for medical trips is difficult, as the exact time at which a person will leave a doctor's office or hospital cannot be

TABLE 5-5. TRANSPORTATION ARRANGEMENTS OF AGENCIES SURVEYED,
BY AFFILIATION WITH ACCESS

<u>Transportation Arrangement</u>	<u>Percentage of ACCESS- Affiliated Agencies Using Arrangement*</u>	<u>Percentage of Non- Affiliated Agencies Using Arrangement*</u>
Operate Agency Vehicles	68	58
Purchase Transportation Services**	100	55
Use Volunteers or Staff Who Drive Their Own Vehicles	33	57
Reimburse Clients for Transportation Expenses	18	18

*Columns do not sum to 100 percent because some agencies use more than one arrangement to provide transportation for their clients.

**Includes transportation purchased through ACCESS.

SOURCE: Human Service Agency Surveys, May 1982; calculations by Charles River Associates.

TABLE 5-6. PURPOSES FOR WHICH ACCESS-AFFILIATED AGENCIES PROVIDE TRANSPORTATION, BY VARIOUS TYPES OF SERVICE

<u>Travel Purpose</u>	<u>Percentage of ACCESS-Affiliated Agencies Providing Service By Any Means*,**</u>	<u>Percentage of ACCESS-Affiliated Agencies Providing Service Using ACCESS**</u>	<u>Percentage of ACCESS-Affiliated Agencies Providing Service Using Agency Vehicles**</u>
Travel to Group-Meal Sites	47	3	39
Travel to Medical or Physical Rehabilitation Appointment	86	75	36
Travel to Group Social Outings and Events	67	22	53
Travel to Training and Employment	66	43	42
Travel for Shopping Purposes	61	11	28
All Purposes	11	0	11

*"By any means" includes service provided in agency vehicles, by contracts with other providers, through ACCESS, by volunteers, and through client reimbursement.

**Columns do not sum to 100 percent because agencies provide trips for more than one trip purpose.

Note: Agencies may use more than one provider to provide trips with similar purposes. For instance, an agency may use both ACCESS and its own vehicles to provide medical trips.

SOURCE: Human Service Agency Surveys, May 1982; calculations by Charles River Associates.

anticipated. Medical trips are, thus, difficult to organize into shared rides. The survey evidence suggests that ACCESS-affiliated agencies are using ACCESS to provide many of their medical trips and, thereby, freeing their agency vehicles to be more productive through serving group trips.

Two other features of Table 5-6 are worth noting. First, there is no discernible pattern in the way in which agencies provide training and employment trips, possibly because such trips may be either pre-arranged for groups or made by one person to one destination. Thus, agency vehicles may be preferred for some, ACCESS for others. Second, while 61 percent of ACCESS-affiliated agencies provide shopping trips, only 11 percent use the broker while 28 percent use agency vehicles for this purpose. Discussions with agency managers suggest that a number of agencies provide these trips with volunteers or by fixed-route service.

Most managers of ACCESS-affiliated agencies rate the broker's service quality as better than or equal to that they relied upon before becoming affiliated with ACCESS. Table 5-7 presents the ratings of various ACCESS service characteristics by agency managers. Agency managers consistently rated ACCESS service as superior to their previous service in terms of driver sensitivity, complaint procedures, availability of service, service hours, and accessible vehicles. The managers rated ACCESS service as equal to or better than their previous service in terms of time spent by clients in the vehicle, vehicle safety, and provision of door-to-door service. The only ACCESS service characteristic that more than 10 percent of the managers rated as inferior to their previous service was time spent waiting for a vehicle to arrive. As discussed in Section 4, there was no significant difference found between ACCESS' on-time performance and that of agency vehicles prior to the demonstration. There was a great deal of variation in on-time performance, however, and certain agencies may find the promptness of ACCESS vehicles more of a problem than others.

Table 5-8 presents the responses of ACCESS-affiliated agency managers to a number of statements concerning ACCESS and its effect on their agencies. The responses indicate that a majority of the agency managers believe that ACCESS provides a variety of benefits for the agency. Most agency managers also agree that ACCESS has helped to control agency transportation costs; that the broker provides a similar or higher-quality service than the agency previously received; that trip scheduling and the registering of complaints is easier with ACCESS; and that ACCESS can negotiate more successfully with carriers than an individual agency can. Interestingly, agency managers agree that their agencies can be more flexible regarding both the amount and timing of the transportation services they provide. An example of this flexibility concerns the AAA's transportation program. Prior to joining ACCESS, the AAA did not provide transportation for its clients on Wednesday, in an effort to increase ridesharing. Using ACCESS, the AAA has eliminated this restriction in the belief that ACCESS serves a sufficient number of trips to permit efficient vehicle usage Monday through Friday. Finally, Table 5-8 corroborates the findings that agencies use ACCESS as a supplement rather

TABLE 5-7. COMPARISON BY ACCESS-AFFILIATED AGENCY MANAGERS OF VARIOUS ACCESS SERVICE CHARACTERISTICS TO PREVIOUS SERVICE*

Service Characteristic	Percentage of Agency Managers Rating Characteristic:					All Agencies
	Much Better Than Previous Service	Somewhat Better Than Previous Service	The Same As Previous Service	Somewhat Worse Than Previous Service	Much Worse Than Previous Service	
Driver Sensitivity	26	35	30	9	0	100
Complaint Procedures	32	36	27	5	0	100
Time Spent Waiting for Vehicle to Arrive	25	25	29	13	8	100
Time Spent in Vehicle	27	14	55	4	0	100
Vehicle Safety	32	14	54	0	0	100
Availability of Service When Needed	36	28	24	8	4	100
Service Hours	36	27	32	5	0	100
Provision of Door-to-Door Service	33	13	46	4	4	100
Accessible Vehicles	35	13	48	4	0	100

*In response to the following question asked of ACCESS-affiliated agency managers:

"Below is a second list of ACCESS service characteristics. Please indicate how these service characteristics differ from the service you received before your agency became affiliated with ACCESS."

Numbers listed represent the percentages of respondents who checked each response.

SOURCE: Human Service Agency Surveys, May 1982; calculations by Charles River Associates.

TABLE 5-8. OPINIONS OF ACCESS-AFFILIATED AGENCY MANAGERS
ABOUT THE BENEFITS OF ACCESS SERVICE

Statement	Percentage of Agency Managers Responding			
	Agree	Disagree	No Opinion	All Agencies
1. Agency transportation costs have decreased or risen more slowly than they would have without ACCESS.	41	19	40	100
2. The agency receives a similar or higher-quality service from ACCESS than it did before.	48	21	31	100
3. The agency is more flexible in the amount of service it can provide for clients.	46	7	47	100
4. The agency is more flexible regarding when it can provide service for its clients.	61	18	21	100
5. The agency has been able to use its vehicles more efficiently by using ACCESS to provide single-passenger trips.*	52	9	39	100
6. Scheduling trips is easier than before.	52	17	31	100
7. It is easier to register complaints about service than before.	45	14	41	100
8. Complaints are resolved in a more satisfactory manner than before.	48	17	35	100
9. ACCESS is an important supplement to our other vehicles when a vehicle breaks down or a driver is unavailable.*	64	5	31	100
10. ACCESS can negotiate with carriers more successfully than an individual agency can.	55	14	31	100

*If an agency had no vehicles of its own, this question was omitted.

SOURCE: Human Service Agency Surveys, May 1982; calculations by Charles River Associates.

than a replacement for agency vehicles, and that agencies use ACCESS to serve trips that are difficult to organize into shared rides. Fifty-two percent of the managers agree with Statements #5 and #9 concerning their use of ACCESS for single-passenger trips and as a supplement to service provided by agency vehicles.

In comparison to these findings, Table 5-9 lists the opinions of managers of non-affiliated agencies concerning coordinated services. A number of findings from this table are worth noting. First, half of the managers believe that some type of coordination would result in lower transportation costs (Statement #1). Second, the managers believe that service quality would decline with coordination, as indicated by their responses to Statement #2 concerning driver sensitivity and Statement #3 regarding service quality. Furthermore, these managers believe that agencies would have less control over their transportation programs in a coordinated system. In contrast, agency managers that use ACCESS also believe that coordination results in lower costs, but the majority has detected no change in service quality; in fact, many have found that service quality has improved. This suggests that while many non-affiliated agencies do not use ACCESS because they are able to successfully meet their transportation needs using other arrangements, some agencies may still be uninformed about the actual nature of ACCESS service.

5.5 SUMMARY

In summary, of the 116 Allegheny County agencies that serve the elderly and/or handicapped, 42 use ACCESS (including 21 that are AAA-sponsored). ACCESS has actively marketed its services to many of these agencies and it appears to have been successful in engaging the participation of agencies that would benefit from a coordinated system. Agencies that do not participate appear to be able to provide the amount of transportation they wish to provide by using agency vehicles and volunteers and by purchasing service. The only agencies that indicated that they purchase large amounts of service outside the ACCESS system are those that serve ambulatory persons using taxis, a method that the agencies believe is more cost-effective for their purposes than ACCESS is.

ACCESS-affiliated agencies use the broker as a supplement to their other transportation services, including their use of agency vehicles. Affiliated agencies use ACCESS to provide many of their single-passenger trips, allowing improved utilization of their own vehicles. This suggests that ACCESS may have had an impact on the productivity of agency vehicles, beyond its effect on those agency vehicles directly engaged in ACCESS service provision.

The agencies consistently rate ACCESS service as equal to or better than their previous service. The agencies also agree that ACCESS has helped restrain transportation costs, allowed greater flexibility in transportation provision, and improved service quality in a number of ways. Overall, the ACCESS system can be considered an important and beneficial innovation from the perspective of many of Allegheny County's human service agencies.

TABLE 5-9. OPINIONS OF NON-AFFILIATED AGENCY MANAGERS REGARDING COORDINATION OF THEIR AGENCY TRANSPORTATION PROGRAMS*

Statement	Strongly Agree	Somewhat Agree	No Opinion	Somewhat Disagree	Strongly Disagree	All Agencies
1. Agency transportation costs would decrease.	7	43	27	7	16	100
2. Drivers in a coordinated program would be as sensitive as our current drivers are.	7	27	16	30	20	100
3. The agency would receive a lower quality of transportation service than it currently receives.	17	30	26	27	0	100
4. The agency would be more flexible in the amount of service it could provide to its clients.	7	31	21	31	10	100
5. The agency would be more flexible regarding when it could provide service for its clients.	14	28	17	24	17	100
6. The agency would have less control over its transportation program.	27	40	20	13	0	100
7. The agency would be able to keep its vehicles in use for longer portions of the day.**	13	31	17	26	13	100

Table continued on following page.

TABLE 5-9 (Continued). OPINIONS OF NON-AFFILIATED AGENCY MANAGERS REGARDING COORDINATION OF THEIR AGENCY TRANSPORTATION PROGRAMS*

<u>Statement</u>	<u>Strongly Agree</u>	<u>Somewhat Agree</u>	<u>No Opinion</u>	<u>Somewhat Disagree</u>	<u>Strongly Disagree</u>	<u>All Agencies</u>
8. The agency would be able to increase ridesharing (the number of passengers in a vehicle).	14	45	14	17	10	100
9. The agency would have difficulty planning a budget for its transportation programs.	13	23	27	24	13	100

*In response to the following question asked of managers of agencies not affiliated with ACCESS:

"Coordinating the transportation of human service agencies through vehicle-sharing or centralized purchasing of transportation services can lead to many changes for the agency. Some of the possible changes are described in the sentences below. Please indicate whether you agree or disagree that these types of changes would occur if (or did occur when) your agency coordinated its transportation program with other agencies."

Numbers listed represent the percentages of respondents who checked each response.

**If an agency had no vehicles of its own, this question was omitted.

SOURCE: Human Service Agency Surveys, May 1982; calculations by Charles River Associates.

6. THE ELDERLY AND HANDICAPPED POPULATION AND ITS USE OF ACCESS SERVICES

A major goal of the Paratransit Brokerage demonstration was to improve the transportation services available to Allegheny County's elderly and handicapped citizens. As discussed earlier, it was anticipated that the broker would have a positive effect on the level and quality of available paratransit services, and that the cost of service would be lowered by increased efficiency in the delivery of services. These changes were expected to benefit the elderly and handicapped generally, as well as agencies providing transportation to elderly and handicapped clients. In Section 4, we described the extent to which actual improvements in service quality and cost were achieved. In this section, we explore these changes from the perspective of ACCESS users.

Concurrent with the start of the demonstration, the Port Authority of Allegheny County instituted a program of user-side subsidies, available only to individuals who were physically unable to board a standard bus. For those eligible, the subsidy represented a substantial discount on the cost of paratransit services. The Port Authority subsidy provided a 75 percent discount on ACCESS scrip through October 1982 and provided an 88.75 percent discount after that time. It was hoped that this Port Authority program, in conjunction with the service quality and cost changes described in the previous paragraph, would represent an important new transportation alternative for those unable to use fixed-route buses.

Programmatically, both the broker and the Port Authority placed great emphasis on the user-side subsidy aspect of ACCESS, and both organizations emphasized ACCESS' potential impact on the mobility of the handicapped throughout the demonstration. To this end, the Port Authority instructed the broker to devote significant effort to the administration, promotion, and monitoring of the user-side subsidy program.

To better understand the results of these efforts, and to learn more about the elderly and handicapped population in general, the Service and Methods Demonstration Program sponsored a travel diary survey in Allegheny County. This effort involved a large telephone screening survey used to randomly locate survey participants, an in-home interview, and a two-week travel diary.* Four groups of people were included in the survey: the

*For a detailed description of this effort, see Charles River Associates, Design and Implementation of the Pittsburgh Travel Diary, prepared for the U.S. Department of Transportation, Transportation Systems Center, 1982.

non-elderly general population, the able-bodied elderly, the transportation-handicapped, and ACCESS registrants. Most of the information in this section is drawn from the travel diary survey.

We begin this section with a description of the elderly and handicapped population of Allegheny County. Next, we compare the characteristics of individuals who have registered for ACCESS with those of individuals who are eligible but have not registered. Third, we examine the use of ACCESS by registrants and its effect on their travel behavior. Finally, we present some evidence about the possible use of lift-equipped buses by the transportation-handicapped.

6.1 INCIDENCE OF THE ELDERLY AND THE TRANSPORTATION-HANDICAPPED IN THE GENERAL POPULATION

From the extensive telephone screening surveys used to locate travel diary participants, we can estimate the incidence of elderly and transportation-handicapped persons in the general population. During the telephone screening phase of the diary survey, over 18,000 randomly-chosen telephone numbers were dialed and successful interviews were completed with 8,647 households. This large, random sample of households provides useful data concerning the number of people in Allegheny County who experience physical difficulty while traveling.

Table 6-1 provides information on the estimated number of people under 60 years of age and 60 years of age or older who experience difficulty in traveling. These data were obtained by combining incidence rates from the telephone screening survey with 1980 U.S. Census statistics. People are classified as being able-bodied, handicapped but able to use standard bus, or handicapped and unable to use standard bus. These distinctions were made on the basis of survey respondents' beliefs about their own physical capabilities. Specifically, during the telephone screening interview, respondents were asked if they had physical difficulty in traveling. People who indicated that they did have difficulty were asked whether or not they would be able to board a PAT bus or streetcar on their own.

From Table 6-1, it can be seen that 79.1 percent of the Allegheny County population is under 60 years of age and able-bodied. A small fraction of the non-elderly population, however, experiences physical difficulty while traveling. This fraction is 1.24 percent of the county population under 60 years of age. Of the estimated 18,010 persons in this age group who indicate that they are transportation-handicapped, 8,157 persons are unable to board a standard bus.

TABLE 6-1. ESTIMATED NUMBER OF PERSONS AND INCIDENCE IN THE GENERAL POPULATION, BY AGE GROUP AND ABILITY TO USE PUBLIC TRANSPORTATION*

<u>Age Group</u>	<u>Ability to Use Public Transportation</u>	<u>Estimated Number of Persons</u>	<u>Percentage of Allegheny County Population</u>
Under 60 Years of Age	Able-bodied	1,146,684	79.10
	Handicapped, can use standard bus	9,853	0.68
	Handicapped, cannot use standard bus	8,157	0.56
60 Years of Age and Older	Able-bodied	238,147	16.42
	Handicapped, can use standard bus	25,058	1.72
	Handicapped, cannot use standard bus	22,186	1.52
All Persons		1,450,085	100.00

*Ability to use public transportation is self-reported. N = 8,647.

SOURCES: Allegheny County Travel Diary Survey, 1981; and U.S. Bureau of the Census, 1980 Census of Population; calculations by Charles River Associates, 1983.

Of those persons who are 60 years of age and older, 238,147 (16.42 percent of the total county population) are able-bodied. A large proportion of the elderly can be considered transportation-handicapped, however, as an estimated 47,244 persons in this age group experience physical difficulty while traveling. Of this group, 22,186 persons are unable to board a standard bus.

We can obtain an estimate of the number of people eligible to use ACCESS from the data presented in Table 6-1. Any elderly (60 years of age or older) and/or transportation-handicapped person can use ACCESS at full price. From Table 6-1, it can be seen that 303,401 persons are eligible to use ACCESS at full price (285,391 able-bodied and handicapped elderly persons and 18,010 non-elderly handicapped persons). These groups compose 20.9 percent of the total county population. A small subgroup of these ACCESS-eligible people qualifies for the Port Authority user-side subsidy. This subgroup includes the 8,157 non-elderly and 22,186 elderly persons who are unable to board a standard bus. Thus, an estimated 30,343 persons, or 2.1 percent of the Allegheny County population, are potentially eligible for the subsidy program.*

The ability to board a standard bus is, of course, the eligibility test for the Port Authority's user-side subsidy program for ACCESS service. Because the data presented here rely on self-reporting while ACCESS relies on certification by the Easter Seals Society, these data reflect a less stringent test of one's ability to use a standard bus than the test employed by ACCESS. Consequently, this estimate of the number of subsidy-eligible people may be an overestimate, to the extent that people's perceptions of their own physical abilities differ from those of ACCESS' certification personnel.

Table 6-2 presents data on the socioeconomic characteristics of the transportation-handicapped population. The table includes information on elderly and non-elderly persons who identify themselves as having difficulty traveling. From the age distribution data presented, it is clear that the elderly account for a large percentage of the transportation-handicapped population. We estimate that 74.8 percent of the transportation-handicapped are 61 years of age or older. The average age of all the transportation-handicapped persons is estimated to be 67 years.

An estimated 35 percent of the transportation-handicapped possess a valid driver's license. The ability to drive greatly enhances one's opportunity to travel. Thus, the fact that many transportation-handicapped

*It is interesting to note that in 1977, on the basis of National Health Statistics, the SPRPC estimated that 2.3 percent of Allegheny County residents were unable to use public transit without aids. This figure includes an estimate of the homebound.

TABLE 6-2. SOCIOECONOMIC CHARACTERISTICS OF THE
TRANSPORTATION-HANDICAPPED POPULATION*

<u>Characteristic</u>	<u>Percentage of the Transportation-Handicapped Population</u>
<u>Age Distribution</u>	
Under 16 years	1.2
16 years to 30 years	4.2
31 years to 45 years	5.0
46 years to 60 years	14.8
61 years to 75 years	43.5
76 years to 99 years	31.3
<u>Possess Valid Driver's License?</u>	
Do possess valid license	35.0
Do not possess valid license	65.0
<u>Gender</u>	
Male	29.0
Female	71.0
<u>Before-Tax Annual Household Income</u>	
Above \$6,000	61.0
Below \$6,000	39.0

*Includes elderly and non-elderly persons identifying themselves as having physical difficulty in traveling. It does not include the able-bodied elderly.

SOURCE: Allegheny County Travel Diary Survey, 1981; calculations by Charles River Associates, 1983.

persons can drive provides evidence that the needs of the physically-disabled for transportation assistance are quite diverse.

Females comprise a much higher percentage of the transportation-handicapped population than of the general population. One reason for this difference is the disproportionate representation of women among the elderly. It should also be noted that females are often over-represented in telephone surveys. However, a special effort was made during the travel diary survey to ensure that women were not disproportionately chosen for interviews. This effort allows us to rule out survey procedures as a major reason for the high percentage of women found among the transportation-handicapped.

From the telephone screening interviews, we also found that the transportation-handicapped are less affluent than the general population. A full 39 percent of the group indicated that the before-tax, annual income of their households was below \$6,000. For these low-income, transportation-handicapped individuals, private travel options may be especially limited.

6.2 COMPARISON OF ACCESS REGISTRANTS AND NONREGISTRANTS

Of the estimated 303,401 people who are eligible to use ACCESS service, approximately 3,000 had registered for ACCESS cards by November 1981. This means that approximately 1 percent of the eligible population has availed itself of the service. It is very important to note, however, that the majority of the eligible population does not qualify for the Port Authority user-side subsidy. Consequently, for the majority, ACCESS is a very expensive travel option, similar in out-of-pocket cost to a ridesharing taxi service. It is, therefore, unlikely to be an attractive routine option for people able to use PAT buses. Furthermore, because most people make use of taxis on only an occasional basis, it is not surprising that few full-price registrants have made the effort to register for ACCESS.

A better measure of ACCESS market penetration is to identify participation among those who are most in need of the service and who are eligible for the Port Authority subsidy. From data presented in Table 6-1, we have estimated that 30,343 persons in Allegheny County are physically unable to board a standard bus. As of mid-1982, ACCESS had certified approximately 2,800 persons as subsidy-eligible, indicating a market penetration rate of 9.2 percent among those unable to use public transportation.

Among nonregistrants who believe they are unable to board a standard bus, 82 percent indicated in the travel diary survey that they did not know about ACCESS. Despite ACCESS' extensive attempts to publicize the program, this evidence suggests that many potential users of ACCESS are unaware of its existence, clearly illustrating the difficulty of promoting special services in a large metropolitan area.

In Table 6-3, we examine the distribution of ACCESS eligibility and participation by group. In the first column, we present estimated percentages of ACCESS-eligible persons by group. It can be seen that the able-bodied elderly, those aged 60 and over, comprise the majority of ACCESS-eligible persons, 78.5 percent. The transportation-handicapped elderly form an additional 15.6 percent of ACCESS-eligible persons; 8.3 percent of eligible persons are elderly and have difficulty traveling but can board a standard bus, while 7.3 percent are elderly and cannot board a standard bus. Transportation-handicapped persons under 60 years of age comprise the remainder of ACCESS-eligible persons. While 3.2 percent of eligible persons are under 60 and transportation-handicapped but able to board a standard bus, 2.7 percent are under 60 and unable to board a standard bus.

Two of the groups listed in Table 6-3 are eligible for the Port Authority subsidy. These groups are elderly and non-elderly persons who are unable to board a standard bus, and they account for 10.0 percent of the total population eligible to use ACCESS service.

The second column of Table 6-3 provides information on the composition of ACCESS registrants. The majority of ACCESS registrants, 88.0 percent, are those who cannot board a standard bus and who are eligible for the user-side subsidy. The actual percentage of ACCESS registrants who have qualified for the subsidy program is even higher than these figures indicate. This discrepancy results from the fact that some elderly persons indicated in our surveys that they are able to use a bus when in actuality they are only able to use the bus sometimes.* These people typically suffer from arthritis or have suffered strokes. Since many of them can qualify for the subsidy program, it is likely that the percentage of ACCESS registrants who qualify for the user-side subsidy program is closer to 95 percent.

The third column of Table 6-3 presents an estimated percentage of ACCESS trips accounted for by each group. These data were compiled from the two-week travel diary. From the diaries of ACCESS registrants, we found that those persons under 60 years of age who qualified for the Port Authority subsidy accounted for 49 percent of all ACCESS trips. Thus, young, severely handicapped individuals account for a larger proportion of ACCESS trips than ACCESS registrants. Those persons 60 and over who are unable to board a standard bus account for 41 percent of all ACCESS trips. The remaining 10 percent of ACCESS trips are attributed to elderly transportation-handicapped individuals who are able to use the bus, at least sometimes. We found no ACCESS trips listed in the travel diaries of ACCESS registrants who are able-bodied and elderly or under 60 years of age and transportation-handicapped but able to use a bus. These two groups can only use ACCESS by paying the full-price fare.

*The surveys did not allow for the answer "sometimes."

TABLE 6-3. ACCESS PARTICIPATION, BY GROUP

<u>I. Individual Participation</u>	<u>Percentage of Eligible Persons*</u>	<u>Percentage of Registrants</u>	<u>Percentage of ACCESS Trips**</u>
Age 60 and over; handicapped but can use a bus	8.3	7.1	10.0
Age 60 and over; cannot board a bus	7.3	53.7	41.0
Age 60 and over; not handicapped	78.5	1.8	0
Under 60 years of age; handicapped but can use a bus	3.2	3.1	0
Under 60 years of age; cannot board a bus	2.7	34.3	49.0
TOTAL	100.0	100.0	100.0

<u>II. Agency-Sponsored Participation</u>	<u>Percent of Total Eligible Persons***</u>
Age 60 and over; handicapped but can use a bus	19.4
Age 60 and over; cannot board a bus	19.1
Age 60 and over; not handicapped	53.5
Under 60 years of age; can use a bus	1.0
Under 60 years of age; cannot board a bus	7.0
TOTAL	100.0

*People were considered ACCESS-eligible for the purposes of this table if they considered themselves unable to board a standard PAT bus.

**Percent of ACCESS trips that are not agency-sponsored.

***"Eligible" means a member of a social service agency that uses ACCESS. All clients of such agencies are considered eligible for service by virtue of agency membership.

SOURCE: Data on individual participation is from the Allegheny County Travel Diary Survey, 1981. Data on social service agency-sponsored participation is from the 1980 agency client survey. Calculations by Charles River Associates, 1983.

The bottom portion of Table 6-3 describes the composition of agency-sponsored ACCESS users. These are the only data that we will present in this section concerning agency-sponsored users.* Most agency-sponsored users are 60 years of age or older and 53.5 percent are able-bodied elderly persons; 19.4 percent are elderly and transportation-handicapped but able to use a bus, while 19.1 percent are elderly persons unable to use a bus. Persons under 60 years of age who cannot board a bus account for 7 percent of agency-sponsored participation, while an additional 1 percent are under 60 and transportation-handicapped but able to use a bus.

In Figure 6-1, we contrast the difficulties experienced by ACCESS registrants while traveling with those of ACCESS-eligible nonregistrants.** It is clear that, as a group, ACCESS registrants are more severely disabled than nonregistrants: 85.2 percent of ACCESS registrants experience difficulty walking over one block, compared to 49.1 percent of nonregistrants. Ninety-two percent of ACCESS registrants experience difficulty boarding or leaving a standard bus while half of the nonregistrants face a similar transportation barrier. Similar comparisons can be made between the two groups for every functional difficulty considered in our surveys.

With regard to mobility aids, Figure 6-2 shows that 43.2 percent of ACCESS registrants require the use of a wheelchair, 41.1 percent must use a cane when walking, and 63.2 percent believe that another person must be with them while they travel. In contrast, an estimated 4.8 percent of nonregistrants require the use of a wheelchair, 19 percent must use a cane when walking, and 32.4 percent believe that another person must be with them while they travel.

A comparison of the socioeconomic characteristics of ACCESS registrants and nonregistrants indicates that ACCESS registrants are younger, more likely to be employed or seeking work, and somewhat less affluent than nonregistrants. Table 6-4 presents the age and income distribution and marital and employment status of the two groups. These differences are at least partially due to the large percentage of nonregistrants who are able-bodied elderly persons.

Table 6-4 also presents some evidence concerning differences between registrants and nonregistrants in their ability to drive an automobile. A

*The effect of ACCESS on agencies has been discussed in a previous section. We do not focus on the broker's influence on agency-sponsored users directly because ACCESS usage by agency clients is entirely controlled by the agencies.

**ACCESS-eligible nonregistrants include the able-bodied elderly and all transportation-handicapped persons who have not registered for ACCESS.

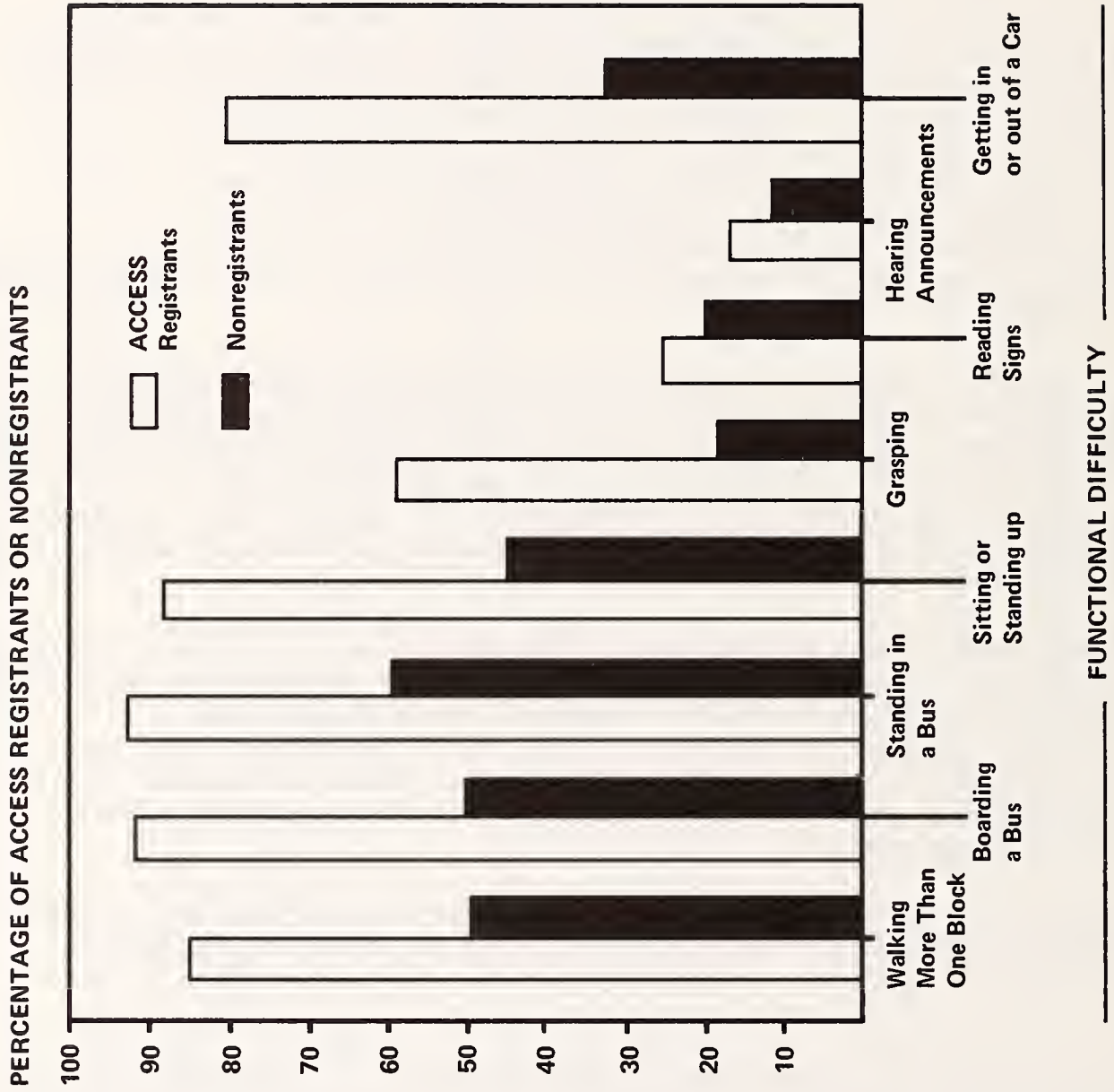

Figure 6-1. PERCENTAGE OF ACCESS REGISTRANTS AND NONREGISTRANTS, BY FUNCTIONAL DIFFICULTY

SOURCE: Allegheny County Travel Diary, 1981; calculations by CRA, 1983.

PERCENTAGE OF ACCESS REGISTRANTS AND NONREGISTRANTS

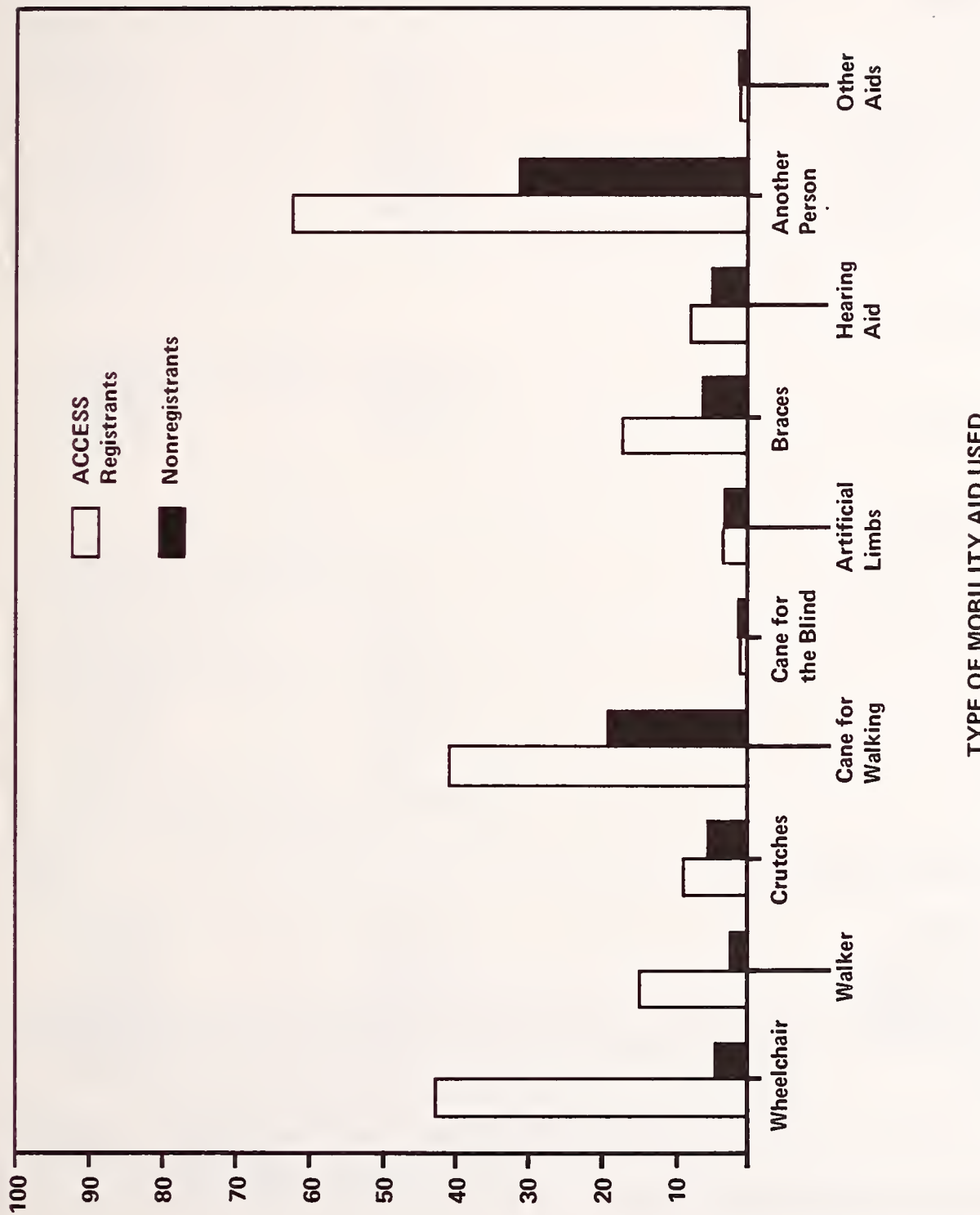

Figure 6-2. PERCENTAGE OF ACCESS REGISTRANTS AND NONREGISTRANTS, BY TYPE OF MOBILITY AID USED

SOURCE: Allegheny County Travel Diary, 1981; calculations by CRA, 1983.

TABLE 6-4. SOCIOECONOMIC CHARACTERISTICS OF
ACCESS REGISTRANTS AND NONREGISTRANTS

	<u>Percentage of ACCESS Registrants</u>	<u>Percentage of Nonregistrants*</u>
<u>Age Distribution</u>		
Under 16 years	2.1	1.2
16 years to 30 years	12.6	4.2
31 years to 45 years	8.7	5.0
46 years to 60 years	16.4	14.8
61 years to 75 years	35.4	43.5
76 years to 99 years	24.8	31.3
<u>Marital Status</u>		
Married	33.0	42.0
Single	29.0	10.5
Formerly Married	38.0	47.5
<u>Employment Status</u>		
Employed Full-Time	4.9	3.6
Employed Part-Time	4.3	3.2
Unemployed	18.4	4.7
Retired	44.8	56.0
Student	9.8	4.0
Homemaker	16.6	24.5
Other	1.2	4.0
<u>Annual Household Income</u>		
Less than \$5,000	28.9	19.1
\$5,000 to \$9,999	37.6	33.7
\$10,000 to \$14,999	16.1	25.2
\$15,000 to \$24,999	11.4	14.6
\$25,000 to \$34,999	3.3	4.5
Over \$35,000	2.7	2.8

Table continued on following page.

TABLE 6-4 (Continued). SOCIOECONOMIC CHARACTERISTICS OF
ACCESS REGISTRANTS AND NONREGISTRANTS

	<u>Percentage of ACCESS Registrants</u>	<u>Percentage of Nonregistrants*</u>
<u>Race</u>		
White	84.0	91.6
Black	16.0	8.3
Other	0.0	0.0
<u>Gender</u>		
Male	34.0	31.8
Female	66.0	68.2
<u>Possess Valid Driver's License?</u>		
Yes	22.5	45.8
No	77.5	54.1
<u>When Last Drove a Car?</u>		
Within 1 Month	8.0	34.3
Within 3 Months	0.0	1.5
Over 3 Months Ago	35.8	2.5
Never	56.2	61.7
<u>Client of Human Service Agency?</u>		
Yes	47.8	29.7
No	52.2	70.3

*Nonregistrants include the able-bodied elderly and all transportation-handicapped persons who have not registered for ACCESS.

SOURCE: Allegheny County Travel Diary Survey, 1981; calculations by Charles River Associates, 1983.

small percentage of the registrants, 22.5 percent, possess a valid driver's license, compared to 45.8 percent of nonregistrants. The percentages of active drivers in both groups appear to be lower than these figures suggest, however. Only 8 percent of ACCESS registrants had driven an automobile within 3 months of the survey date, while 35.8 percent of nonregistrants had driven within 3 months of the survey date. Together, these data indicate that traveling as an automobile driver is an option available to only a limited segment of nonregistrants and to a very small segment of ACCESS registrants.

Finally, Table 6-4 shows that 47.8 percent of ACCESS registrants are clients of a human service agency. This high rate of affiliation with agencies reflects the fact that most ACCESS registrants rely on human service agencies for rehabilitation, medical assistance, sheltered workshops, and training programs. Furthermore, 49.4 percent of ACCESS registrants who are agency clients indicated that they receive transportation assistance from an agency. In contrast, 30 percent of nonregistrants are clients of a human service agency and, of this group, 35 percent report receiving transportation assistance from an agency.

Often, the transportation resources of individuals are supplemented by the resources of other people sharing the same household. In Table 6-5 we compare the household characteristics of four groups: the non-elderly, able-bodied general population, able-bodied elderly nonregistrants, transportation-handicapped nonregistrants, and ACCESS registrants. In comparison to the non-elderly general population, the elderly and the transportation-handicapped in general reside in smaller households. The average number of people per household for the non-elderly general population is 3.56 persons, compared to 2.06 persons in households containing an able-bodied elderly person, 2.47 in households containing a transportation-handicapped nonregistrant, and 2.36 in households containing an ACCESS registrant.

In examining the average number of automobiles per household, we find that the differences between the four groups are not quite so great. Households containing non-elderly members of the general population average 1.86 autos per household. Households containing an able-bodied elderly person average 1.45 autos per household. Households containing a transportation-handicapped nonregistrant average 1.43 autos while households containing an ACCESS registrant average 1.12 autos.

Differences in the average number of drivers per household are greater than differences in auto ownership. Households containing non-elderly members of the general population average 2.18 drivers. In contrast, households containing the able-bodied elderly, transportation-handicapped nonregistrants, and ACCESS registrants average 1.24 drivers, 1.18 drivers, and 0.79 drivers, respectively. Again, the available evidence suggests that ACCESS registrants as a group have limited private transportation options.

TABLE 6-5. VARIOUS HOUSEHOLD CHARACTERISTICS BY GROUP:
 GENERAL POPULATION, ABLE-BODIED ELDERLY, TRANSPORTATION-HANDICAPPED
 NONREGISTRANTS, AND ACCESS REGISTRANTS

Household Characteristics	Non-Elderly General Population		Able-Bodied Elderly Nonregistrants		Transportation- Handicapped Nonregistrants		ACCESS Registrants
	Average Number of People in Household	3.56	2.06	2.47	2.36		
Average Number of People in Household Who Are Handicapped	.04	.13	1.00	1.12			
Average Number of People in Household Over 65 Years of Age	*	1.22	0.84	0.81			
Average Number of Cars per Household	1.86	1.45	1.43	1.12			
Average Number of Drivers in Household	2.18	1.24	1.18	0.79			

*Sample size insufficient.

SOURCE: Allegheny County Travel Diary Survey, 1981; calculations by Charles River Associates, 1983.

People who are eligible to use ACCESS, either at full-price or with the user-side subsidy, and who have not registered were asked why they do not participate in the ACCESS program. Table 6-6 lists the reasons cited by nonregistrants in response to this question. The reason most often cited by nonregistrants for nonparticipation is that sufficient information about ACCESS was not available to them. This response was given by 56 percent of respondents. Many of these people had simply never heard of ACCESS. The second most frequent reason cited for nonparticipation is the absence of a need for specialized service. Almost 40 percent of respondents have adequate transportation available to them without ACCESS. A small portion of nonregistrants do not participate in ACCESS either because they believe they are ineligible for the Port Authority subsidy or because they have been denied certification for the subsidy program. It is interesting to note that these people have not registered for ACCESS use at the full-price fare. A minority of nonrespondents indicated that objections to ACCESS service quality factored in their decision not to participate: 2.1 percent believe that ACCESS is inconvenient to use, while less than 1 percent suggest that they have a bad impression of ACCESS.

6.3 USE OF ACCESS BY REGISTRANTS AND ITS EFFECT ON THEIR TRAVEL BEHAVIOR

6.3.1 Reasons for Using ACCESS and the Convenience of Registering

The reasons why registrants use ACCESS are many but they all reflect ACCESS' unique service characteristics. As is evident in Table 6-7, over 31 percent of ACCESS registrants surveyed indicated they use ACCESS because it is their only travel option. Two other groups of respondents also indicated their dependency on the specialized service; 14 percent stated that they use ACCESS because they need door-to-door service and 11.7 percent stated that they need an accessible vehicle for travel. These responses clearly illustrate the importance of ACCESS to a large segment of its users, in the absence of other transportation services within the financial reach of the severely handicapped.

Some registrants, 18.7 percent, stated that they use ACCESS because it is affordable compared to other travel options, such as exclusive-ride taxi service or unsubsidized chair-cars. Another group, 17.3 percent of respondents, stated that they like ACCESS service characteristics such as door-to-door service and assistance from drivers. A small percentage of respondents, 5.6 percent, replied philosophically that ACCESS gives them independence by freeing them from continual reliance on others for transportation.

TABLE 6-6. REASONS CITED BY NONREGISTRANTS
FOR NOT PARTICIPATING IN THE ACCESS PROGRAM*

<u>Reasons for Nonparticipation</u>	<u>Percentage of Nonregistrants Citing the Reason</u>
Have adequate transportation already	39.7
Do not have sufficient information about ACCESS	56.0
Not eligible for Port Authority subsidy	6.5
In process of joining ACCESS	1.0
ACCESS is too inconvenient	2.1
Have a bad impression of ACCESS	0.7

*Multiple responses were recorded.

SOURCE: Allegheny County Travel Diary Survey, 1981; calculations by
Charles River Associates, 1983.

TABLE 6-7. STATED REASON FOR USING ACCESS

<u>Stated Reason</u>	<u>Percentage of Responses*</u>
Only way person has to travel	31.8
Gives independence	5.6
It saves money or is affordable	18.7
Need door-to-door service	14.0
Need accessible vehicles	11.7
Like service characteristics	17.3
Other reason	0.9
All Responses	100.0

*Multiple responses were recorded.

SOURCE: Allegheny County Travel Diary Survey, 1981; calculations by Charles River Associates, 1983.

Table 6-8 lists the ways in which ACCESS registrants heard about ACCESS. The largest group of respondents, 34.2 percent, heard about the broker through a human service agency. This reflects both ACCESS' efforts to coordinate its activities with local agencies and the importance of agencies as a means of communicating information to the handicapped. An additional 30.4 percent of respondents heard about ACCESS from friends or relatives, some of whom may have seen the broker's newspaper advertisements or noticed television and radio public service messages. Only 1.9 percent of registrants initially became aware of ACCESS service by direct contact with the ACCESS office.

The second and third panels of Table 6-8 provide information concerning ACCESS registrants' opinions on the ease of registering for ACCESS: 77.6 percent of respondents believe that it is convenient to register for ACCESS, while 22.4 percent disagree. Of those who find registration inconvenient, essentially all experienced difficulty traveling downtown for certification procedures. ACCESS does hold certification sessions at local agency centers, but apparently some people still experience difficulty obtaining an ACCESS card.

The largest percentage of this group, 67.6 percent, had difficulty arranging transportation to the downtown certification site. Another 17.6 percent of those who found registration inconvenient found it difficult to travel downtown because of poor health, while 11.8 percent found it expensive to travel downtown.

6.3.2 Frequency and Purpose of ACCESS Usage

Studies of specialized transportation systems often find that a core of frequent users is responsible for a large portion of total service provision. This pattern of usage is consistent with the pattern of ACCESS usage we found through the travel diary survey. It appears, however, that because of the strict eligibility requirements imposed by the Port Authority on its user-side subsidy program, the core of frequent ACCESS users represents quite a large percentage of total registrants. That is to say, because of the effort required to obtain subsidy status, a large percentage of the people who register for ACCESS actually use the service.

The frequency of ACCESS usage by participants is explored in Tables 6-9, 6-10, 6-11, and 6-12. Table 6-9 provides information on the frequency of ACCESS use by registrants: 35.6 percent of surveyed registrants indicated that they had used ACCESS within 7 days (one week) of the survey date. An additional 22.2 percent stated that they had used ACCESS within the past month, and 22.7 percent had used it within the past year. Less than 20 percent of registrants had never used ACCESS or had not used it in the past year.

TABLE 6-8. HOW ACCESS REGISTRANTS HEARD ABOUT ACCESS AND THEIR OPINIONS ABOUT THE CONVENIENCE OF REGISTERING

I. HOW REGISTRANTS HEARD ABOUT ACCESS

<u>Method of Receiving Information</u>	<u>Percentage of Respondents</u>
Newspaper	3.7
Radio or television	3.1
Human service agency	34.2
Religious organization	1.3
Through friends or relatives	30.4
From ACCESS directly	1.9
Other method	25.4
All Respondents	100.0

II. CONVENIENCE OF REGISTERING

<u>Opinion About Ease of Registering</u>	
It is convenient to register	77.6
It is inconvenient to register	22.4
All Respondents	100.0

III. REASON FOR FINDING REGISTRATION INCONVENIENT

<u>Reason for Inconvenience*</u>	
It's difficult to get downtown - transportation-related	67.6
It's difficult to get downtown - health-related	17.6
It's too expensive to travel downtown	11.8
Other reason	3.0
All Respondents	100.0

*These responses are from those respondents who considered registration inconvenient.

SOURCE: Allegheny County Travel Diary Survey, 1981; calculations by Charles River Associates, 1983.

TABLE 6-9. TIME PERIOD SINCE LAST ACCESS TRIP

<u>Time Period</u>	<u>Percentage of Registrants</u>
Within the last week	35.6
Within the last month	22.2
Within the last year	22.7
Over one year or never	19.5

SOURCE: Allegheny County Travel Diary Survey, 1981; calculations by Charles River Associates, 1983.

TABLE 6-10. PERCENTAGE OF ACCESS REGISTRANTS USING ACCESS DURING PAST YEAR, BY AGE GROUP

<u>Age Group</u>	<u>Percentage of Age Group Using ACCESS at Least Once in Past Year</u>
Under 16 years	43
16 years to 30 years	77
31 years to 45 years	80
46 years to 60 years	87
61 years to 75 years	86
76 years to 99 years	91

SOURCE: Allegheny County Travel Diary Survey, 1981; calculations by Charles River Associates, 1983.

TABLE 6-11. PERCENTAGE OF ACCESS REGISTRANTS,
BY FREQUENCY OF ACCESS CARD USE

<u>Number of Weekly One-Way Trips Using ACCESS Card</u>	<u>Percentage of ACCESS Registrants</u>
0	52.9
1	2.9
2	20.7
3	3.6
4	5.7
5 - 10	12.1
11 - 15	2.1
All Registrants	100.0

SOURCE: Allegheny County Travel Diary Survey, 1981; calculations by Charles River Associates, 1983.

TABLE 6-12. ACCESS TRIPS AS A PERCENTAGE OF TOTAL TRIPMAKING
BY ACCESS REGISTRANTS

<u>ACCESS Trips As a Percentage of Total Trips</u>	<u>Percentage of ACCESS Registrants</u>
No ACCESS trips	52.9
Ten percent or less	2.1
From 11 to 20 percent	8.6
From 21 to 30 percent	7.1
From 31 to 40 percent	5.0
From 41 to 50 percent	4.3
From 51 to 60 percent	0.7
From 61 to 70 percent	1.4
From 71 to 80 percent	2.9
From 81 to 90 percent	0.7
From 91 to 100 percent	14.3

SOURCE: Allegheny County Travel Diary Survey, 1981; calculations by Charles River Associates, 1984.

Table 6-10 shows usage of ACCESS by age group. It can be seen from the table that active use of the broker is positively related to age. Only 43 percent of registrants under 16 years of age had used ACCESS at least once in the past year. In comparison, 91 percent of those registrants between 76 and 99 years of age had used ACCESS at least once during the same period.

Table 6-11 presents data on the frequency of ACCESS card usage. These data were obtained directly from ACCESS registrants' travel diaries. Only those who used the broker at least once during the year prior to the survey date were asked to complete a travel diary. These data, therefore, reflect only "active" users. They show that slightly over half, 52.9 percent, of the ACCESS registrants participating in the survey made no trips using the broker during an average week.* A total of 32.9 percent of registrants made between 1 and 4 one-way ACCESS trips during an average week. Relatively frequent users, those making between 5 and 10 weekly one-way trips, composed 12.1 percent of registrants. Those persons making 11 to 15 one-way trips per week made up only 2.1 percent of registrants. The average number of weekly ACCESS trips per registrant is estimated to be 1.9 one-way trips.** These figures indicate that a large segment of ACCESS registrants are not frequent users, even though the majority of registrants had used ACCESS at least once in the year prior to our survey. There is, however, a sizable core of registrants who are clearly frequent users, some perhaps using ACCESS for job commuting.

When we consider ACCESS trips as a percentage of total tripmaking, we find that there is a group of registrants that relies very heavily on ACCESS for transportation. As shown in Table 6-12, slightly over half of ACCESS registrants participating in our survey made no ACCESS trips. However, an estimated 14.3 percent of registrants used ACCESS for more than 90 percent of their total tripmaking. This group constitutes 30 percent of those unsponsored individuals who made any trips at all on ACCESS during the survey weeks. Clearly, ACCESS and the Port Authority subsidy play an important role in the transportation plans of these handicapped individuals.

While some users are very reliant upon ACCESS, on average registrants make 26 percent of their total trips using ACCESS service. (This figure accounts for those registrants who make no trips using ACCESS.) We find no significant difference between full-fare users and subsidized users in this respect. It must be noted that our sample of full-fare users is very small (N=16 for this statistic).

*The travel diary covered a two-week period.

**If we include registrants who have never made an ACCESS trip or who did not make a trip in the year prior to the survey, the average number of one-way trips per week is closer to 1.5 trips.

Evidence from the travel diary survey on the trip purpose distribution of ACCESS trips supports the hypothesis that some registrants use the broker for work trips. As shown in Table 6-13, 28.1 percent of ACCESS trips (excluding return-home trips) were made for work-related purposes. An additional 8.8 percent of ACCESS trips were for travel to and from school. This finding further confirms the importance of ACCESS in the daily routine of some of its users.

The second-largest category of ACCESS trips was travel for medical purposes; 24.3 percent of ACCESS trips were made for this purpose. There is also significant demand for shopping trips, with 5.7 percent of ACCESS trips made for shopping purposes. Most specialized transportation systems are called upon to provide transportation to and from medical appointments and for shopping trips; the desire of the elderly and handicapped population for this type of assistance appears to be universal.

It is interesting to note that ACCESS also provides many so-called "non-essential" trips for its registrants. Under this heading are 16.6 percent of ACCESS trips made for personal business, 3.8 percent made to visit friends or relatives, 1.9 percent made to eat a meal away from home, 2.6 percent made to engage in a religious activity, 4.3 percent made traveling to an entertainment site, and 1.9 percent for traveling to a recreation site. This type of usage is actively supported by Port Authority policy, which allows the user-side subsidy to be used in traveling for any purpose and which has led to ACCESS' extensive service hours.

In the travel diary survey, respondents were asked why they do not use ACCESS more often. The response most frequently given, as shown in Table 6-14, was that the respondent had no need for more transportation or that poor health prevented him or her from traveling more often. The remaining responses related to aspects of ACCESS service quality, in particular the punctuality of vehicle arrival and trip scheduling procedures.

6.3.3 Opinions About ACCESS Service Quality

In general, ACCESS registrants are pleased with the service quality they receive. There are, however, several ways in which registrants would like to see service improved.

Table 6-15 lists the responses of ACCESS registrants to questions about various aspects of service quality. The overwhelming majority of respondents (more than 85 percent in all cases) felt that ACCESS drivers are friendly and courteous; that assistance is provided to passengers entering and leaving the vehicle; that vehicles are clean and safe; and that, in general, ACCESS provides a satisfactory level of service.

TABLE 6-13. TRIP PURPOSE DISTRIBUTION OF ACCESS TRIPS
DURING DIARY WEEK*

<u>Purpose</u>	<u>Percentage of ACCESS Trips Including Return-Home Trips</u>	<u>Percentage of ACCESS Trips Excluding Return-Home Trips</u>
Work	16.2	28.1
School	5.1	8.8
Shopping	3.3	5.7
Personal Business	9.6	16.6
Medical	14.0	24.3
Eat Meal	1.1	1.9
Religious Activity	1.5	2.6
Visit Friend or Relative	2.2	3.8
Entertainment	2.5	4.3
Recreation	1.1	1.9
Return Home	42.3	---
Other	<u>1.1</u>	<u>2.0</u>
	100.0	100.0

*Does not include agency-sponsored trips.

SOURCE: Allegheny County Travel Diary Survey, 1981; calculations by Charles River Associates, 1983.

TABLE 6-14. STATED REASON FOR NOT USING ACCESS MORE OFTEN

<u>Stated Reason</u>	<u>Percentage of Responses*</u>
No need; poor health	60.2
Vehicles are not punctual	12.3
Scheduling is inconvenient	10.5
Escorts are not always available	5.3
Drivers or schedulers are rude	3.5
Cannot afford to travel more	8.2
All Respondents	100.0

*Multiple responses were recorded.

SOURCE: Allegheny County Travel Diary Survey, 1981; calculations by Charles River Associates, 1983.

TABLE 6-15. OPINIONS OF ACCESS REGISTRANTS
ABOUT VARIOUS ASPECTS OF SERVICE QUALITY

<u>Service Quality Question</u>	<u>Percentage Responding</u>	
	<u>Yes</u>	<u>No</u>
Is the driver usually friendly and courteous?	93	7
Does the driver provide assistance in getting in or out of vehicle?*	90	10
Are the vehicles usually clean and safe?	85	15
Has ACCESS provided satisfactory service?	85	15

*Asked only of those persons who require such assistance. Seventy-six percent of ACCESS registrants indicated that they need assistance.

SOURCE: Allegheny County Travel Diary Survey, 1981; calculations by Charles River Associates, 1983.

In a related series of questions, one-third (33 percent) of registrants surveyed believe that ACCESS' advance reservation system causes problems for them or reduces the number of trips they might otherwise make. Of those who experience this difficulty, 58 percent indicated a preference for a same-day reservation system. Same-day service is currently provided by ACCESS, but only on an as-capacity-allows basis. Apparently, some users are unfamiliar with this policy or have been denied same-day service. A smaller group, 13 percent of those who find the reservation system cumbersome, claimed that service is not available when they want to travel. Another group, 11 percent of those experiencing difficulty, dislikes ACCESS procedures for scheduling return trips, many of which are made on a will-call basis. (A will-call return means that the user calls the carrier when he or she is ready to be picked up.) Some passengers object to the waiting time entailed with this procedure.

Perhaps the most important criticism of ACCESS service quality, however, relates to the on-time performance of the broker's vehicles. As shown in Table 6-16, the service improvement most frequently suggested by registrants is that service should be more punctual. Despite ACCESS' improvements in this area, some registrants are still inconvenienced by the tardy or early arrivals of vehicles. Table 6-16 also shows other suggested service improvements for ACCESS.

In a related series of questions, 30 percent of registrants claimed that they are not usually picked up by their ACCESS carrier at the scheduled time. When asked how long they usually have to wait, respondents supplied times ranging from 5 to 90 minutes. The average perceived waiting time, among those who felt they did not usually receive punctual service, was 39 minutes. It should be emphasized, however, that the majority of respondents stated that they are usually picked up on time.

The ACCESS scrip system seems to be working well from the user's perspective. Only a few registrants believe that they have been asked by a driver to pay an incorrect fare. Less than 5 percent of respondents indicated that they have had difficulty obtaining scrip from the ACCESS office. Most of these people feel it takes too long to receive scrip through the mail. We also asked respondents about whether or not they tip ACCESS drivers. Taxi drivers sometimes feel that serving special groups is undesirable because of limited tipping. Interestingly, 64 percent of surveyed registrants stated they usually tip their ACCESS driver.

6.3.4 Changes in Travel Behavior

The implementation of a system such as ACCESS can lead to two types of changes in the travel behavior of its users. First, it can change mode choice; that is, the new specialized service can be substituted for less desirable modes of travel. This mode switch can result from the lower

TABLE 6-16. SUGGESTED ACCESS SERVICE IMPROVEMENTS

<u>Suggested Improvement*</u>	<u>Percentage of Responses</u>
Service should be more punctual	26
Trip requests should be communicated to drivers more accurately	4
Vehicles should be kept cleaner	5
Better equipment is needed	7
Schedulers should be more courteous	3
Drivers should provide more assistance, be more courteous	8
Service should be immediately available for emergencies	5
Service should be available with less advance notice for shopping and personal business	8
Less advance notice should be acceptable for weekend trips	4
More service should be available when needed	5
Reduce waiting time on will-call returns	2
Call riders when vehicles are late	4
Lower the cost of service	4
Allow riders a choice of vehicles	2
Expand service hours	2
Other suggested improvements	11
All Responses	100

*Multiple responses were recorded.

SOURCE: Allegheny County Travel Diary Survey, 1981; calculations by Charles River Associates, 1983.

out-of-pocket cost of the new service, its service qualities, or simply its ability to reduce dependency on other modes. Second, the new specialized service can lead to changes in other travel choices (destinations, frequency, time of travel, etc.). In general, it can induce travel through the removal of major barriers to travel. This second behavioral impact presupposes that some people have the desire for mobility -- to participate in certain activities that are constrained by barriers to travel. As we explain below, the evidence suggests that ACCESS has led to both types of travel behavior changes.

It is clear that, for subsidized users, ACCESS represents a significant reduction in the cost of accessible service. As illustrated in Figure 6-3, total use of ACCESS service has grown steadily between 1979 and 1982 and a significant portion of this growth can be attributed to the Port Authority user-side subsidy. Besides cost, high service quality and the degree to which ACCESS offers the handicapped independence are factors explaining usage of the broker.

Measuring the degree to which ACCESS trips represent a modal switch from another travel mode is a complicated task. Few people make the same trips every week from year to year, and, thus, it is difficult to know what mode would have been used in the absence of one particular travel option. This is particularly true of the elderly and handicapped because many of them are not employed and have highly variable travel behavior.

To indicate those travel modes from which ACCESS registrants might have switched, we asked registrants about their most frequent mode of travel prior to their using ACCESS. As shown in Table 6-17, the most frequent means of travel prior to ACCESS for 45 percent of respondents was by auto. Twenty percent of respondents stated that a taxi or jitney was their most frequent travel method prior to ACCESS, and 11.4 percent used PAT buses. It is likely then, that, to the extent ACCESS trips represent substitution from other modes, the broker is replacing travel by auto or in a taxi or jitney.

In order to better understand what modal switches may have occurred with the implementation of ACCESS, we can focus on those individuals who make regularly-scheduled trips using the broker. Because of the routine nature of these trips, substitution of one mode for another can be inferred without a great deal of concern that frequency or destination will also have changed. The results are informative and are shown in Table 6-18. Of those ACCESS registrants making regularly-scheduled trips, 39.7 percent previously made the trip as an auto passenger, 14.7 percent used a taxi or jitney, 11.8 percent traveled by agency vehicle, and 7.4 percent used PAT buses. A small fraction, 1.5 percent, previously made the trip as an auto driver. These data give us some indication of the modes from which ACCESS has attracted passengers. The previous dependency of many registrants on travel as an auto passenger suggests the importance of ACCESS in providing flexibility and independence in travel.

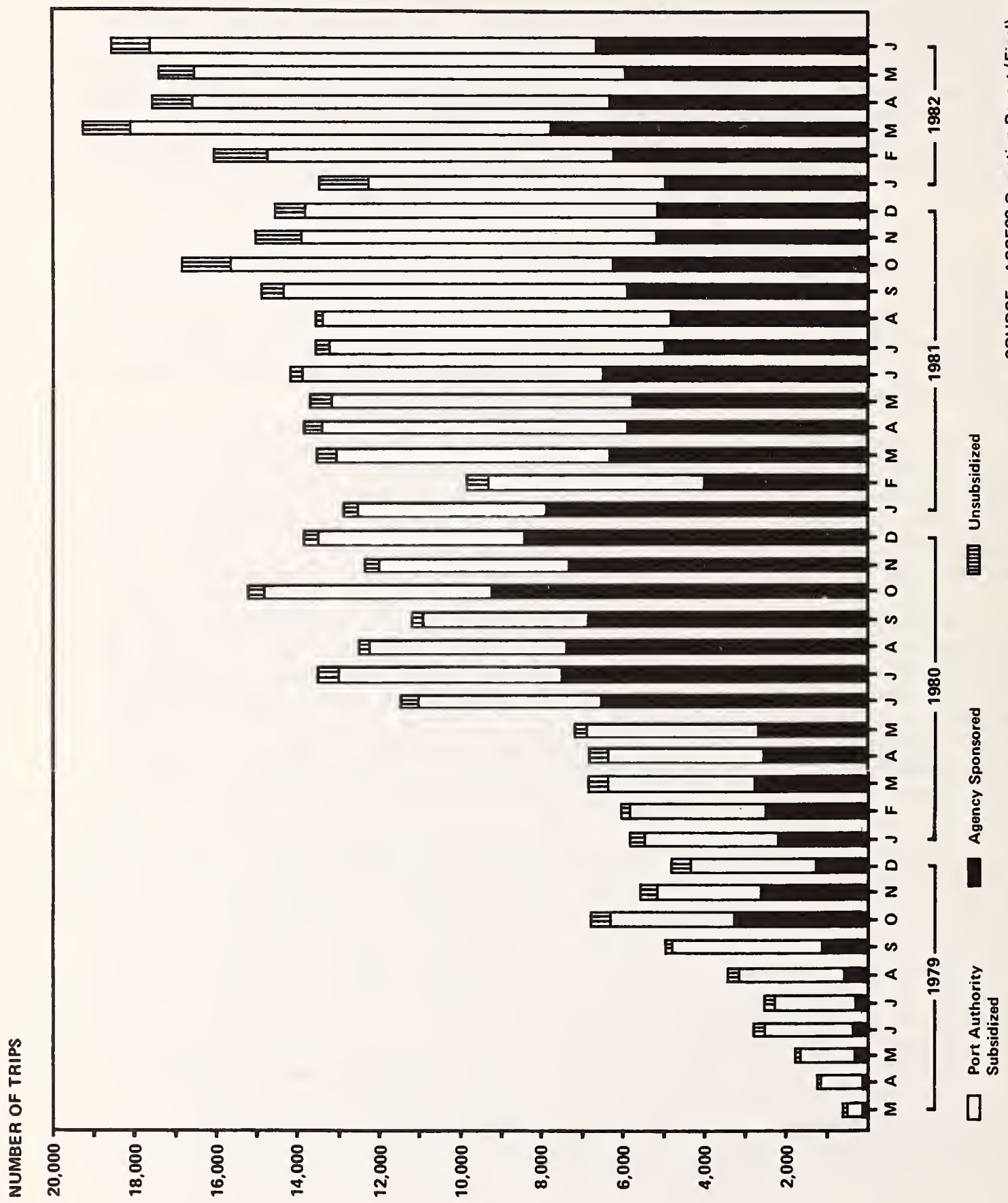

SOURCE: ACCESS Operation Report (Final).

Figure 6-3. NUMBER OF TRIPS BY TYPE OF SUBSIDY

TABLE 6-17. MOST FREQUENT METHOD OF TRAVEL BEFORE ACCESS REGISTRATION

<u>Method of Travel</u>	<u>Percentage of Respondents</u>
Walk or Wheelchair	2.9
Auto Driver	7.1
Auto Passenger	45.0
Taxi or Jitney	20.0
PAT Bus	11.4
Agency Vehicle	8.6
Other Method	5.0
All Respondents	100.0

SOURCE: Allegheny County Travel Diary Survey, 1981; calculations by Charles River Associates, 1983.

TABLE 6-18. PREVIOUS TRAVEL MODE USED FOR
REGULARLY-SCHEDULED TRIPS CURRENTLY MADE USING ACCESS

<u>Previous Travel Mode</u>	<u>Percentage of Respondents Making Regularly-Scheduled Trips on ACCESS*</u>
Auto Driver	1.5
Auto Passenger	39.7
Taxi or Jitney	14.7
PAT Bus	7.4
Agency Vehicle	11.8
Other Travel Mode	5.8
Did Not Make Trip Before	19.1
All Respondents	100.0

*Sixty-one people in the sample of ACCESS registrants reported making regularly-scheduled, non-agency-sponsored ACCESS trips.

SOURCE: Allegheny County Travel Diary Survey, 1981; calculations by Charles River Associates, 1983.

It is important to note, as shown in Table 6-18, that 19.1 percent of those making regularly-scheduled trips state they did not make the trip before ACCESS. While it is true that some of these trips would be made without the broker, it is reasonable to assume the availability of ACCESS has been a causal factor in the taking of some of these trips. This issue is discussed further in the next paragraphs.

Many ACCESS registrants perceive that, in addition to modal choice, other travel choices have changed because of the availability of ACCESS service. As shown in Table 6-19, 46 percent believe they set out for destinations they could not travel to before ACCESS, and 32 percent believe they go to destinations that are farther away than the places they could reach before. With regard to flexibility in the timing of travel, 34 percent of respondents believe they are able to make trips at times different from those during which they used to travel before ACCESS; 36 percent believe that they are able to make trips on different days of the week.

These data strongly suggest that ACCESS has played a role in improving the mobility of the handicapped. This conclusion is supported by a preliminary econometric analysis that sought to identify the unique contribution of ACCESS to changes in total tripmaking by the handicapped.* A more full-scale analysis is beyond the scope of this evaluation. The preliminary econometric analysis results support the hypothesis that ACCESS has led to increased tripmaking by the severely handicapped. Specifically, the data suggest that ACCESS has increased the number of trips made by registrants for discretionary (personal business, entertainment, recreation, etc.) purposes, but not for employment or medical purposes. This result is consistent with the belief that some trips are essential and will be made even at great cost. ACCESS' contribution with regard to these essential trips (as reflected by travelers' substitution of ACCESS for another mode) has been a reduction in out-of-pocket costs and the improvement of service quality. ACCESS' contribution with regard to discretionary tripmaking, however, appears to be an increase in overall mobility.

*On the basis of travel diary data, cross-sectional comparisons of tripmaking by severely handicapped registrants and nonregistrants were made. These analyses were complicated by the simultaneous (two-way) cause-and-effect relationships involved. In particular, it is difficult to delineate the distinct influences of ACCESS participation on trip rates, and trip rates on the decision to participate in the ACCESS program.

TABLE 6-19. PERCEIVED CHANGES IN OTHER THAN
MODE CHOICE BECAUSE OF ACCESS

<u>Because of ACCESS, Does Respondent:</u>	<u>Percentage Responding</u>	
	<u>Yes</u>	<u>No</u>
Go places couldn't go before?	46	54
Go places farther away?	32	68
Make trips at different times than before?	34	66
Make trips on different days than before?	36	63

SOURCE: Allegheny County Travel Diary Survey, 1981; calculations by Charles River Associates, 1983.

6.4 THE ABILITY OF ACCESS REGISTRANTS AND NONREGISTRANTS TO USE LIFT-EQUIPPED BUSES

Lift-equipped buses are often cited as an alternative or complement to specialized, demand-responsive transportation systems. As part of the travel diary survey, CRA investigated the self-evaluated ability of Allegheny County's transportation-handicapped to use standard and lift-equipped buses. The findings are shown in Table 6-20.

The first panel of Table 6-20 shows the perceived ability of transportation-handicapped nonregistrants and ACCESS registrants to board PAT buses and to reach the PAT bus stop nearest their home.* It can be seen that 44.2 percent of the transportation-handicapped and 88.8 percent of ACCESS registrants believe that they are physically unable to board a standard PAT vehicle. Among those individuals who are able to board a standard bus, 41.2 percent of the transportation-handicapped and 10.1 percent of ACCESS registrants are able to reach the bus stop nearest their home. The remaining individuals, 14.6 percent of the transportation-handicapped and 2.1 percent of ACCESS registrants, are physically able to board a standard bus but are unable to reach the bus stop.

The second panel of Table 6-20 presents information on the perceived ability of individuals unable to board a standard bus to use lift-equipped buses. Because the Port Authority does not operate lift equipment, these perceptions are necessarily based only on the respondents' impressions about this form of transportation. It must be noted, furthermore, that these perceptions may be colored by the belief that ACCESS and accessible buses would compete for the same transportation funds. Nevertheless, they provide valuable information about the portion of the handicapped population that might be willing to use such special equipment if it were available.

As can be seen from the table, 31.9 percent of those transportation-handicapped unable to board a standard bus believe that they would not be able to use lift buses if they were available. Of the remaining 68.1 percent who believe they would be able to use the equipment, 48.6 percent would not be able to reach the bus stop. This leaves 19.5 percent of those unable to use standard buses who believe that they are able both to use lift equipment and to reach the bus stop nearest their home.

Among ACCESS registrants, 51.7 percent of those unable to use standard buses believe that they would be unable to use lift-equipped buses if they were available. Although 48.3 percent believe they would be able to use lift-equipped buses, only 26.5 percent believe they would be able to use the special buses and reach the bus stop nearest their home.

*Transportation-handicapped nonregistrants do not include the able-bodied elderly.

TABLE 6-20. ABILITY TO USE STANDARD AND LIFT-EQUIPPED BUSES, BY GROUP

	<u>Percentage of Transportation- Handicapped Nonregistrants</u>	<u>Percentage of ACCESS Registrants</u>
<u>I. Ability to Use Standard Buses</u>		
Physically able to board a PAT vehicle		
--and able to get to bus stop	41.2	10.1
--and not able to get to bus stop	14.6	2.1
Not physically able to board a PAT vehicle	44.2	88.8
All Persons	100.0	100.0
<u>II. Ability to Use Lift Buses</u>		
<u>By Those Unable to Use Standard Buses</u>		
Able to use lift buses if available		
--and able to get to bus stop	19.5	26.5
--and not able to get to bus stop	48.6	21.8
Not able to use lift bus if available	31.9	51.7
All Persons	100.0	100.0

SOURCE: Allegheny County Travel Diary Survey, 1981; calculations by Charles River Associates, 1983.

These data suggest that the market for lift-equipped bus transportation is limited both by handicapped individuals' perceptions of their ability to use the special equipment, and by their ability to get themselves to the bus stop. From this perspective, it appears that door-to-door services, like ACCESS, are the only form of public transportation that a large segment of the handicapped population would be willing to use.

6.5 SUMMARY

There are an estimated 303,401 elderly and transportation-handicapped individuals in Allegheny County. These groups constitute 20.9 percent of the county population. A subgroup of the elderly and handicapped is unable to board standard Port Authority Transit buses. This latter group numbers an estimated 30,343 persons and comprises 2.1 percent of the county population.

Both elderly and transportation-handicapped persons are eligible to use ACCESS. An estimated 90 to 95 percent of ACCESS participants are drawn from those handicapped individuals who are unable to board a standard bus. This suggests that the availability of the Port Authority's user-side subsidy is a major incentive for participation.

ACCESS registrants constitute an estimated 9.2 percent of those unable to board a standard bus. This relatively low market penetration rate appears to result from the availability of private transportation options for many handicapped persons and from the unawareness of many handicapped persons that ACCESS even exists.

A comparison of ACCESS registrants and nonregistrants indicates that, as a group, ACCESS registrants are more likely to require the use of such mobility aids as wheelchairs, walkers, or canes. They are also, as a group, younger, more likely to be employed or seeking work, and less affluent than are nonregistrants. A larger percentage of ACCESS registrants than nonregistrants are affiliated with human service agencies and receive transportation assistance from an agency.

ACCESS registrants appear to have more limited private transportation options than do either elderly or transportation-handicapped nonregistrants. The households they reside in have fewer automobiles and fewer drivers on average. All three groups, however, reside in households with smaller average numbers of automobiles and drivers than those of the general public. ACCESS registrants are also less likely than nonregistrants to possess a valid driver's license.

ACCESS registrants generally express satisfaction with the transportation services they receive from the broker. Two important areas in which improvement is desired are ease of registering for the service and on-time performance of ACCESS vehicles.

Approximately 20 percent of ACCESS registrants have never used the service or had not done so in the year prior to our surveys. Among those who used ACCESS at least once in the year prior to the survey, the average number of one-way ACCESS trips taken per week was 1.9. The range of weekly one-way trips observed was from 0 trips to 15 trips.

The most frequent purpose for which ACCESS is used is work-related travel. Medical trips are the next most frequently taken, followed by personal business and school trips. ACCESS provides a high percentage of so-called "non-essential" trips (i.e., non-work/school/medical), reflecting the Port Authority's decision to allow relatively unconstrained use of its user-side subsidy program.

ACCESS appears to have led to two types of travel behavior changes: modal shifts and increased tripmaking. Analyses of the mode used most frequently by registrants prior to ACCESS and of regularly-scheduled trips suggest that the broker has attracted trips formerly made in autos or taxis. Preliminary evidence also suggests that ACCESS has led to increased tripmaking by some of its registrants, with the increase tending to be for discretionary (non-work) trip purposes.

An examination of the potential use of lift-equipped buses by ACCESS-eligible transportation-handicapped individuals was also made. Based on individuals' perceptions of their own abilities, we find that the market for lift-equipped buses is limited both by a perceived inability to use the equipment itself and by an inability to reach the bus stop.

In conclusion, ACCESS provides a valuable transportation service to a small segment of the population. This segment, however, is clearly very much in need of transportation assistance. ACCESS registrants are severely handicapped and have limited private transportation options. Many of them are, nevertheless, fully-employed individuals who have a wide variety of desired trip purposes. ACCESS appears to have had a positive effect on their transportation behavior, both through the transferral of trips from less-preferred modes and through increased tripmaking.

Despite the considerable success of ACCESS in assisting the handicapped, however, many transportation-handicapped individuals are still unfamiliar with the program. ACCESS should, therefore, exert additional effort to distribute information on its unique and valuable services more widely.

7. CONCEPT FEASIBILITY AND TRANSFERABILITY

In previous sections, we have explored the design and administrative cost of the ACCESS system as well as its effect on paratransit suppliers, human service agencies, and individual users. In this section, we summarize the results of the brokerage demonstration by assessing the extent to which the project has met the goals originally set for it by its sponsors, the Port Authority of Allegheny County and the Service and Methods Demonstration Program. In the course of this discussion, we draw some conclusions regarding the transferability of these results to other localities.

7.1 RESULTS IN MEETING THE OBJECTIVES OF THE PORT AUTHORITY

As discussed in Section 1.3.1, two major goals of the Port Authority for the brokerage demonstration can be identified. First, the Authority supported the demonstration as a means of meeting its commitment to the local elderly and handicapped communities. This commitment was partly an outgrowth of a multi-year, continuing effort by the Port Authority and the SPRPC to respond to public concern about transportation for the elderly and handicapped. This concern was voiced formally to the SPRPC and the Authority through an Advisory Committee, composed of elderly and handicapped citizens, transportation providers, human service agencies, and government agencies. The Advisory Committee supported the institution of a paratransit broker as an important step in improving the access of nonambulatory citizens to paratransit services. The Port Authority agreed to implement the brokerage demonstration.

The second goal of the Port Authority for the demonstration was to fulfill Federal Section 504 requirements with a program of paratransit service and user-side subsidies, rather than through purchase of lift-equipped buses. Because of the local topography and the experience of other communities with accessible buses, the Port Authority endorsed paratransit as the best local solution to deficiencies in public transportation provision for the nonambulatory.

By sponsoring the demonstration throughout its three-year history and by continuing the ACCESS project after completion of the demonstration, the Port Authority obviously met its commitment to support the program. Between July 1979 and June 1982, the Port Authority provided \$888,096 in direct subsidization of the broker's transportation operations, not including its program of user-side subsidies. The Port Authority, therefore, provided both organizational and financial support for the program.

With regard to its second goal, providing paratransit service rather than accessible, fixed-route bus service, the Port Authority and ACCESS have demonstrated that paratransit is a feasible option for Allegheny County. As shown in Table 6-20, only a small percentage of ACCESS registrants and transportation-handicapped nonregistrants believe they would be able to use accessible buses. In contrast, the ACCESS program has become an integral part of the specialized transportation network. It is used by almost one-half of the county's human service agencies serving the elderly and handicapped. In addition, it provides over 6,000 trips each month for unaffiliated users.

The Port Authority has followed a program of providing a large subsidy to a well-defined group for an unlimited number of trips. For those who have taken advantage of the program, the unlimited nature of the subsidy seems to have influenced their use of ACCESS. Many ACCESS trips are taken for social and recreational purposes as well as for employment, suggesting very active use by a small segment of the population. Not surprisingly, preliminary research suggests that the subsidy has led to increased tripmaking by some participants.

This method of distributing subsidies, while undoubtedly beneficial to the severely mobility-constrained people who use it, must be contrasted with the provision of limited subsidies to a broader group, implemented by several other communities.* Only about 1 percent of the total elderly and handicapped population participate as individuals (i.e., non-agency-sponsored participants) in the ACCESS program. A more broadly distributed program would probably result in a broader distribution of subsidy funds, but it would also alter the way the program is used by those unable to use standard buses. The choice between the two program designs, when there is a constraint on total program funding, is a difficult one.

Given the Port Authority's goal of aiding those for whom accessible bus service would be designed, it is a reasonable choice to narrowly limit eligibility for the user-side subsidy. However, stringent eligibility requirements make active promotion of the program essential. In our survey of the transportation-handicapped, we found that many people who may qualify for the user-side subsidy program had not heard of it. This strongly suggests that further promotion of the ACCESS program would bring the Port Authority closer to its goal of aiding the nonambulatory through user-side subsidies.

*See Bruce D. Spear, "User-Side Subsidies: Delivering Special-Needs Transportation Through Private Providers," Transportation Research Record, No. 850, 1982.

7.2 RESULTS IN MEETING THE OBJECTIVES OF THE SERVICE AND METHODS DEMONSTRATION PROGRAM

Six issues were identified in Section 1.3.2 as nationally-important key objectives of the Pittsburgh Paratransit Demonstration. Previous sections of this report have discussed these issues in detail. Here, we briefly summarize our findings and attempt to draw some lessons from this demonstration for use by other localities.

7.2.1 Overcoming Regulatory and Institutional Barriers

The first issue investigated was the ability of the broker to overcome regulatory and institutional barriers to coordination. The broker was successful in overcoming these barriers, as evidenced by the integrated system it currently manages. Two aspects of the broker's experience in implementing this system are worth highlighting.

First, regulatory and institutional barriers to coordination had an important effect on the timing of the project. Regulatory disputes slowed the SMD grant approval process and caused the broker to begin operations in an uncertain regulatory environment. Perhaps more important, institutional barriers to agency participation significantly delayed full realization of the project's scope. The AAA refused to purchase service from the broker until one and one-half years into a demonstration originally scheduled to extend over a two-year period. This delay limited the scale of broker operations during its first years of operation, and led to unexpected market effects. It does not, however, seem to have had a long-term impact on the broker's effectiveness.

A second aspect of ACCESS' experience with regulatory and institutional barriers to coordination concerns the impact of regulation on the paratransit industry. As discussed in Section 4, regulation had a lasting effect on the behavior of paratransit providers and probably reduced the number of carriers available to the broker. Both of these impacts made it difficult for the broker to stimulate competition for its trip requests and to use this competition to control costs. In response, the broker devoted increasing resources over the course of the demonstration to monitoring carrier records and scheduling procedures.

Localities considering the implementation of a paratransit broker or a user-side subsidy program should consider the regulatory environment into which the program will be introduced. This should be done not just to assess the possibility for successful implementation but also to anticipate the influence of regulation on the program's design and costs. In areas where competition has been limited, the realization of potential cost savings through industry competition might take several years.

7.2.2. Administrative Procedures and Costs

The second nationally important issue investigated in the demonstration relates to administrative procedures and the cost of the broker's administrative functions. The administrative procedures of the broker were described in detail in Section 3. Carrier contracting procedures have worked well and over time have become a central focus of ACCESS' drive to reduce transportation costs. Both its accounting functions and its third-party billing system have performed smoothly and have met with consumer approval. One improvement in administrative procedures noted by individual users has been an easing of the travel burden to the user-side subsidy certification site in downtown Pittsburgh.

It should also be noted that the broker has found it beneficial not to perform the functions of trip scheduling and dispatching. Currently, the broker does no dispatching and schedules only some agency trips (a small portion of its total monthly trips). Although these functions were once considered for inclusion by ACCESS designers (in a very early design stage), it was believed that these functions would duplicate existing carrier facilities and that their costs would not be offset by increased productivity.

ACCESS' administrative costs provide mixed evidence concerning the feasibility of the brokerage form of coordination. The per-trip costs of broker administration were rather high during its first year of operation (\$3.71 per trip), reflecting initial start-up costs and low patronage. In fiscal years 1981 and 1982, administrative costs averaged \$1.84 and \$1.51 per trip, respectively. In fiscal year 1982, administrative costs totaled 14.6 percent of total program costs. Thus, while steady progress in reducing administrative costs was achieved, these costs remain rather high on a per-trip basis.

Whether or not other localities will experience a level of administrative costs similar to that achieved by ACCESS depends on a number of factors. Two of the most important appear to be the number of total trips brokered and proper management. The administrative expenses of the broker are unlikely to increase at the same rate at which the number of brokered trips increases. Many of the functions of the broker including contracting, marketing, and some bookkeeping procedures remain fairly uniform, regardless of the number of trips handled. This fact is illustrated by the reduction in ACCESS' administrative costs as a percentage of total program costs (transportation and administrative costs) over time.

The second important factor in the achievement of ACCESS' administrative cost level is its management and the duties assigned to the broker. ACCESS staff perform only those administrative activities considered necessary, but the mandate given ACCESS by the Port Authority is broad. ACCESS performs many time-consuming functions, including carrier monitoring and other labor-

intensive activities. Where possible, part-time labor is employed by ACCESS management to minimize labor expenses. Furthermore, the broker tries to avoid unnecessary capital expenditures. Computerized scheduling was rejected as an administrative expense that would not be recouped through lower transportation costs. In 1982, the ACCESS office did acquire a microcomputer, but only after the administrative demands of the office had developed to the point where the benefits of computerizing records had become apparent.

7.2.3 Effectiveness in Improving Service Quality

The third issue considered in the demonstration was measurement of the effectiveness of the broker in improving the quality of paratransit services supplied to the community. CRA found that ACCESS has been successful in achieving improved service quality as measured by increased geographic availability, longer service hours, greater availability of accessible vehicles, and improved complaint-handling procedures. Through analysis of driver manifest data, we also found that ACCESS appears to have reduced trip circuitry, increased the effective speed of travel, and improved the on-time performance of its vehicles. Over a wide variety of service characteristics, the majority of agency managers rate ACCESS as equivalent to or better than their previous service. Individual users are also satisfied with the broker's service, although many would like to see further improvement in the on-time performance of ACCESS vehicles.

Localities impressed with these results should be mindful of the cost of achieving them. These improvements have resulted from the allocation of more resources to paratransit than were allocated to paratransit before the demonstration; they must either be paid for by someone or be achieved through increased efficiencies. As shown by ACCESS, transportation deficits can occur when sufficient economies are not immediately forthcoming. During the demonstration, funding for ACCESS' transportation deficits came from both the Port Authority and the Federal SMD program. It is only since July 1983 that ACCESS has approached its goal of 100 percent cost recovery.

7.2.4 Effect of the Broker on Transportation Costs

The fourth issue investigated by the demonstration evaluation was the effect of the broker on the costs of transportation services. It was expected that the broker would achieve cost savings through increased ridesharing and through the encouragement of competition among providers.

With regard to ridesharing, the ACCESS experience indicates that the simple aggregation of trips will not in itself lead to increased ridesharing for the coordinated part of a transportation network. Because of the system's design, many agencies found it desirable to transfer long-distance and unique trips to ACCESS, thus freeing their own vehicles for more productive group trips. As a result of this behavior and the unique demands of its user-side subsidy patrons, the broker did not find that more trips meant higher productivity for its vehicles over time. Agencies do use ACCESS selectively, however, suggesting that ACCESS did achieve higher vehicle productivity serving many trips formerly served by the agencies individually. In this sense, coordination made the transportation system, taken as a whole, more productive.

Similarly, ACCESS' experience indicates that competition among carriers is not an automatic response to regulatory reform and the introduction of a broker. The broker must overcome the reluctance of carriers to engage in competition. This can only be accomplished where there is at least the potential for entry of new firms into the market. ACCESS has shown that competition can be stimulated during carrier contracting if two or more carriers are capable of serving the same geographic area. Under these conditions, cost reductions may be achieved. Where the broker must rely on only one carrier for specific trips without competition from other carriers, the broker has little leverage in restraining the cost of carriers' transportation contracts.

The broker must also be careful not to become a barrier to entry itself. ACCESS did enforce strict carrier requirements in its first years of operation, basing its qualification requirements in part on the past record of carriers in service to the elderly and handicapped. While these standards were designed to ensure a high quality of service, they resulted in the exclusion of new carriers from the ACCESS network. ACCESS eventually relaxed these standards to allow new providers into the network and to reduce its transportation costs. Now that these carriers have been integrated into the network, ACCESS is working with the providers in making any necessary service quality improvements.

7.2.5 Response of Human Service Agencies

The fifth issue addressed in the demonstration was the response of human service agencies to the broker. Two results are worth noting, one pertaining to the number of agencies using ACCESS and the second to the ways in which these agencies use the broker.

From ACCESS' experience with human service agency participation, it appears that a necessary condition for any agency's involvement is the realization of real benefits from the purchase of service through a broker.

Those agencies that participate in the ACCESS system perceive a number of benefits deriving from participation, including lower transportation costs, more flexible service hours, and greater flexibility in the amount of service they can provide their clients. On the other hand, those agencies that do not participate generally appear to have little to gain by participation. They are either provided with satisfactory service from existing suppliers or are able to meet their own transportation needs.

Another difficult-to-document factor in agency participation is related to the political climate. Those agencies that receive substantial support from local sources are sensitive to the political environment. These agencies seek to deliver transportation services without provoking complaints from the people they serve; they also hesitate to participate in a coordination project if they perceive a possibility for deterioration in service quality. Because of such factors, some agencies will not respond to a promise or even a guarantee of lower transportation costs through the use of a broker. In such cases, the broker may find it necessary to market coordinated services to an agency's funding source as well as to the agency itself.

With regard to how agencies use ACCESS, the broker's experience, combined with the experiences of other brokerage programs, suggests that a system's design plays a key role in determining its usage. The ACCESS system seems to provide an economical alternative for agencies sponsoring trips that are difficult to group into shared rides. This does not imply that ACCESS receives no pre-grouped, regularly-scheduled trips from agencies; it does serve many trips of this kind. Rather, it suggests that ACCESS provides difficult-to-group trips at a lower cost to the agency than the agency can itself manage. This situation is beneficial to the agency but difficult for the broker. The broker cannot cover its transportation costs from agency revenues unless it can serve these trips more efficiently than the agencies, but these trips, by their very nature, induce low vehicle productivities. If the broker cannot achieve the required efficiencies, it must raise its agency fare schedule.

An alternative to this situation is to design a system that is economical for group trips but not for single-passenger trips. Such a system is in use in Lancaster, Pennsylvania.* With a sliding scale of fares, the broker in Lancaster provides a cost incentive for agencies to group trips. This design would not meet the needs of every locality, but it does provide a useful example of how system design influences system usage.

*See LISTS: Transportation Brokerage for the Elderly and Handicapped in Lancaster, PA. UMTA/TSC Evaluation Series Report No. UMTA-MA-06-0049-84-6, June 1984.

7.2.6 Effect of the Broker on the Transportation-Handicapped

The final objective of the demonstration was to examine the effect of the broker on the mobility of the transportation-handicapped. The broker, in conjunction with the user-side subsidy program, has led to an improvement in existing mobility options and, for some groups, the creation of new or at least newly-feasible options.

The ability of handicapped persons to travel when and where they choose is often limited by the transportation options available to them. Because of their special requirements, transportation modes such as the conventional bus network and taxicabs are inaccessible to many handicapped persons. In Allegheny County before the demonstration, handicapped persons unable to use a bus or taxi faced extremely limited transportation options. Someone requiring the use of a wheelchair, for example, would probably have found it necessary to provide for the majority of his or her trips through private resources (through friends or relatives or, in some cases, as a driver). Transportation was also available for some trip purposes through human service agencies. In addition, for those in the city of Pittsburgh, Magic Carpet provided accessible service at a subsidized price. This important resource was available in only a small segment of the county, however.

ACCESS changed this situation in some very important ways. First, the broker made paratransit service available in every portion of the county. Second, ACCESS made accessible vehicles available throughout the county, a difficult task given the county's size. Third, ACCESS strove to offer high-quality service and to achieve a uniform level of quality throughout its service area. Furthermore, when the broker is not successful in delivering quality service, there is a complaint procedure that gives riders a chance to be heard. Fourth, through the demonstration, ACCESS gradually increased its hours of operation, extending service to between 6 a.m. and midnight and to seven days a week. Finally, ACCESS has tried to reduce its advance reservation requirements. It has fallen short of actively implementing a reduced reservation time, however, because of the broker's belief that this last improvement will benefit some but not all its patrons. Thus, through the many ways it has made improved-quality paratransit more readily available, the broker has increased the travel options of the transportation-handicapped.

It must be noted, however, that while the brokerage demonstration made paratransit service physically available and accessible, the user-side subsidy program made paratransit economically accessible to handicapped individuals. As evidenced by the travel diary survey, the transportation-handicapped as a group have lower than average incomes. Given the small number of non-agency-sponsored persons who use ACCESS at full price, it is clear that the subsidy program has been extremely important in making paratransit a feasible option for many of those unable to board a standard bus. Without the subsidy program, it is unlikely that a significant number of unaffiliated individuals would use the broker's services -- it would simply be too expensive.

With the user-side subsidy program, ACCESS service has increased the mobility of a segment of the transportation-handicapped population. Many ACCESS trips represent a switch from a less-preferred mode, usually auto, to the broker. Other trips, as the evidence suggests, are new trips that would not have been undertaken in the absence of the program. Furthermore, these new trips are probably clustered under the rubric of "non-essential" trips -- social, recreational, and shopping trips, among others. Thus, the mobility improvements derived from increased tripmaking are most likely due both to the existence of the user-side subsidy program and to its unrestricted nature -- the fact that trip subsidies can be used for any trip purpose. Thus, the effect of ACCESS on the mobility of the transportation-handicapped is a function of the broker's supply improvements, the availability of user-side subsidies, and the unrestricted use of these programs.

In conclusion, the Pittsburgh Paratransit Brokerage Demonstration provides valuable experience concerning the difficulties and complexities of introducing a full-scale paratransit broker into a complicated regulatory environment. ACCESS' achievements have been substantial, and its organizational design and administrative procedures provide useful models for other localities. In considering the formation of a paratransit broker, however, localities should carefully assess the characteristics of their local paratransit industry and human service agencies to evaluate potential transportation efficiencies and level of agency participation. The experience in Pittsburgh underscores the strong influence of pre-implementation conditions in shaping the ultimate performance of the broker. Finally, we note the essential contribution of the user-side subsidy program to the broker's success in improving the mobility of a segment of the transportation-handicapped population. Economic barriers to increased tripmaking by the handicapped, like physical barriers, must be confronted by those who advocate paratransit rather than accessible buses to remedy deficiencies in public transportation provision.

APPENDIX A. ACCESS CARRIER VEHICLE
INSPECTION PROGRAM

ACCESS CARRIER VEHICLE INSPECTION PROGRAM

Carrier: _____

Vehicle Make and Model: _____

Date: _____

Model Year: _____

Inspector: _____

Fleet No.: _____

Signature: _____

License Plate No.: _____

Instructions:

Complete all items. Check the appropriate box unless deficient; then fill in the blank or describe the deficiency in the comment space provided at the bottom of the page. Use extra page if necessary. Put the item number beside each comment.

Fill out this page for each vehicle used in dedicated ACCESS service. If van or bus, attach and complete the appropriate additional sheet.

- | | | |
|--|------------------|----------|
| 1. <u>Current Inspection Sticker</u> | _____ Yes | _____ No |
| 2. <u>Seats</u> | | |
| a. Number of Seats | _____ | _____ |
| b. Number of Seat Belts | _____ | _____ |
| c. Shortest Belt Length | _____ | _____ |
| d. All Seat Belts in Working Condition | _____ Yes | _____ No |
| e. Minimum Seat Width | _____ $\geq 18"$ | _____ No |
| f. Minimum Seat Depth | _____ $\geq 16"$ | _____ No |
| g. Clearance for Legs | _____ $\geq 10"$ | _____ No |
| h. All Permanent Seats Forward Facing | _____ Yes | _____ No |
| i. Seats of Fire-Resistant Material | _____ Yes | _____ No |

3. Wheelchair Positions

a. Number of Positions _____

b. Number of Tiedowns _____

c. Number of Passenger Seat Belts _____

d. Shortest Belt Length _____

4. Lighting

a. Directionals _____ Yes _____ No

b. Hazard Lights _____ Yes _____ No

c. Interior Light, Engine On _____ Yes _____ No

d. Interior Light, Engine Off _____ Yes _____ No

5. General

a. Sharp Protuding Edges Inside Vehicle _____ Yes _____ No

b. Grab Bars or Other Assists _____ Adequate _____ No

c. Exterior _____ Acceptable _____ No

d. Interior _____ Acceptable _____ No

e. Doors Can Be Opened from Inside _____ Yes _____ No

COMMENTS:

VANS

6. Wheelchair Entrance

- a. Curb Side Yes No
- b. Door Type _____ Swing Other
- c. Horizontal Clearance _____ $\geq 39"$ No
- d. Vertical Clearance _____ $\geq 57"$ No
- e. Tiebacks Yes No
- f. Lighting of Lift Area Yes No

7. Wheelchair Loading - Lift

- a. Minimum Loading Design _____ ≥ 600 Lbs.
- b. Non-Skid Platform Yes No
- c. Side Barriers Yes No
- d. Anti-Roll-Off Barrier or Wheel Locks Yes No
- e. Inside Controls Yes No
- f. Outside Controls Yes No
- g. Secure from Unauthorized Operation Yes No
- h. Electrically Powered by Vehicle Yes No
- i. Smooth, Non-Jerking Motion Yes No
- j. Power Failure Mode - Can Be Lowered with Passenger Yes No
- k. Power Failure Mode - Can Be Raised/ Unloaded Yes No
- l. Power Failure Mode - Will Not Collapse from Stored Position Yes No
- m. Operative Warning Signal When Door Is Not Properly Closed Yes No
- n. Maximum Intrusion Into Vehicle When Stored _____ $\leq 14"$ Other
- o. Hazardous Exposed Moving Parts _____ Yes No

8. Ramp (Optional in Lieu of Lift)

- a. Metal Yes No
- b. Folding, Counterbalanced Yes No
- c. Maximum Intrusion Into Vehicle When Stored _____ $\leq 14''$ Other

9. Wheelchair Restraint

- a. Adjustable Tie-Downs for Each Wheelchair Position Yes No
- b. Type:
- Belts Bar Wheelwell
- Other (Specify) _____
- c. Seatbelts for Passengers in Wheelchairs Yes No
- d. Maximum Length of Seat Belt for Wheelchair Passenger _____

10. Emergency Door

- a. Rear Door Yes No
- b. Seats Obstructing Yes No
- c. Minimum Aisle Width Clearance _____ $\geq 14''$ Other
- d. Can Be Opened from Inside Yes No

11. Roof

- a. Collapse-Resistant Steel Rollover Edge Yes No
- b. Maximum Vertical Clearance, Any Passenger Entrance _____ $\geq 72''$ Other
- c. Minimum Vertical Clearance in Aisle _____ $\geq 72''$ Other
- d. Insulated Roof Yes No

12. Ambulatory Passenger Entrance

- a. Height of Entrance Step Without Riser _____
- b. Height of Entrance Step With Riser _____
- c. Width of Riser _____
- d. Riser Secured to Vehicle _____ Yes _____ No
- e. If No, Describe Riser _____

13. Emergency Equipment

- a. Fire Extinguisher _____ Yes _____ No
- b. Flares _____ Yes _____ No
- c. First Aid Kit _____ Yes _____ No

14. Temperature Control

- a. Heating System _____ Yes _____ No
- b. Air Conditioning _____ Yes _____ No
- c. Fans _____ Yes _____ No
- d. Rear Windows (for Passengers) Which
Open and Close _____ Yes _____ No

USE BACK OF SHEET FOR ADDITIONAL COMMENTS

APPENDIX B. MATERIALS FOR ACCESS DRIVER
SENSITIVITY TRAINING PROGRAM



AGENDA

ACCESS Driver Training Program

Oct. 3, 1981 -- 8:15 - 12:30 AM

United Cerebral Palsy Association

8:15 - 9:30	What is ACCESS: Funding/federal laws Coordination Paperwork Driver requirements
9:30 - 10:00	Understanding Elderly and Handicapped Passengers
10:00 - 10:15	Coffee Break
10:15 - 11:00	Assistance Techniques Wheelchair handling Assistance to blind passengers Demonstrations
11:00 - 11:15	Slide Show - Safety
11:15 - 11:30	Demonstration on Van
11:30 - 12:00	Passenger Relations Sensitive Issues Scheduling Problems Confidentiality Requests for help you can't give Complaints Difficult types of passengers
12:00 - 12:15	Community Resources
12:15 - 12:30	General Questions/Comments



I. Understanding ACCESS Riders

A. The Elderly Rider

1. Reactions to unfamiliar situations
2. Need for reassurance
3. How do you talk to an older person?
4. The economics of being elderly
5. Mental confusion and loss of memory
6. Losses and the elderly

B. The Handicapped Rider

1. Sickness and disability
2. How do people acquire handicaps?
3. How do you talk to a handicapped person?
4. Should you have sympathy for the handicapped?

II. Public Relations

1. Sensitive issues in passenger assistance
2. Scheduling problems
3. Confidentiality
4. Passenger requests for help you can't give
5. Passenger complaints addressed to the driver
6. Difficult types of passengers

PASSENGER ASSISTANCE TECHNIQUES

- I. NEED
 - A. WHO BENEFITS?
 - B. WHY INVEST IN TRAINING?
- II. DRIVER'S PERSPECTIVE
 - A. FEELING COMPETENT
 - B. PRIDE IN WORK
 - C. CONCERN FOR PASSENGER SAFETY
- III. PASSENGER'S PERSPECTIVE
 - A. SAFETY
 - B. SECURITY
 - C. RELIABILITY
- IV. MANAGER'S PERSPECTIVE
 - A. SERVICE CONSIDERATIONS
 - B. PASSENGER SAFETY
 - C. INSURANCE
 - D. PUBLIC IMAGE
- V. SOME EXAMPLES
 - A. BASIC PRINCIPLES OF ASSISTING PASSENGERS
 - B. BASIC PRINCIPLES OF WHEELCHAIR MANAGEMENT
 - C. DO'S AND DON'TS
- VI. DISCUSSION AND EXAMINATION

Reminder! All these issues will be discussed as the movie depicts examples of each situation. Veteran drivers are encouraged to voice their recommendations based on past experiences.

Wheelchair Maneuverability

1. Demonstrate all working parts (brakes, foot rests, fold up, tilt, arm rest, removal).
2. Scenes of in and out door, up and down ramp, up and down curb, and up and down steps.
3. Some suggestions: plan ahead and consult advice of consumer.

Hydraulic Lift (Know you van; each is different.)

1. The position of vehicle operator varies depending on their weight and the concerns of the consumer.
 - a. stand on lift during movement
 - b. some stand in front or beside hydraulic lift during operation
 - c. heavy operators are encouraged not to stand on lift.
2. Put up safety bar on bottom of lift.
3. Secure passenger's brakes.
4. If possible - put one hand on chair and one hand on operating button

Wheelchair Positioning

1. Plan ahead for who sits where.
2. Small amount of space.
3. Watch your back; use muscles in knees.
4. Secure the wheels in the rods.
5. Put brake and seat belt on - most important concern of consumer.
6. Face little wheels in same direction as big wheels.
7. Ask customer if he feels secure.

Non Wheelchair Passenger

1. If necessary assist customer from home into van seat.
2. Ride with passenger up hydraulic lift by holding him or her in such a way to secure both of your balances.
3. Watch head when going into the van.
4. Assist into seat.
5. Help secure seat belt.

Wheelchair Transfer

1. Because of limited wheelchair space, it sometimes is necessary to transfer customer from his chair into seat.
2. Try to use your leg muscles rather than back.
3. If passenger agrees, select one who can transfer himself easily or with little assistance.
4. Secure with seat belt.
5. Fold up wheelchair and position in van some where securely.
6. Never put a customer on the floor.

Amount of Assistance Provided

1. Ask customer what kind of assistance he or she may need.
2. Please try to encourage independence wherever and whenever possible.
3. When assisting a person don't be afraid to touch but also show respect (consider how you would feel in that situation).

Positioning for Easy Pick Up and Departures

1. Plan ahead. Where is the most accessible point?
2. Allow enough turn around space for wheelchair positioning.
3. Pull up as close to the curb as possible.

Vehicle Movements

1. Smooth starts and stops.
2. Remember you are not the only passenger in vehicle.

3. Don't take unnecessary risks (it may cause an accident or loss of your job).
4. Take your time: don't let passengers pressure you into rushing.
5. Concentrate on driving (potholes, etc)
6. Take bends slowly: wheelchairs tip easily.

Vehicle Maintenance

1. Cleanliness of van and seat belts.
2. Keep van in safe operating condition.
3. Notify carrier if van is unsafe for transportation purposes.

Other Considerations

1. Time inconvenience (ride the van for 2½ hours to get to destination - shared ride).
2. Plan a week day ahead of time.
3. Kidney problems (length of time on van).
4. Heater, air conditioner, window, radio - consider comfort of customer.
5. Waiting time for pick up may be 2 hours.
6. If van breaks down and you foresee a long wait for repair, then have courtesy to notify dispatcher to call parent about delay.

(There will also be a free handout about the different kinds of disability).

IV. Actual Simulation of Van Ride

The vehicle operators will be divided into two groups for this sensitivity exercise. Each driver will select a type of disability and in turn, use the appropriate type of adaptive equipment to simulate the real experience. Disabilities and adaptations will include:

Partially sighted	Saran Wrap covering eyes
Speech problems	Use language board to communicate needs
Deaf	Cotton
Wheelchair	Standard and electric

Braces

Sling

Splint

Reciprocal Walker

Walker

Crutches

Canes

The vehicle operator may experience a combination of the above handicapping conditions.

1. Bad Ride - While driving to Three Rivers Stadium with a van full of workshop participants temporarily disabled with the help of special aids, a designated vehicle operator will demonstrate the "wrong" way to provide van service. Hopefully the drivers will become sensitive to what it feel like if the role of passenger and vehicle operator are reversed.
2. Good Ride - On the return trip the designated vehicle operator will now give the best kind of transportation service based on the recommendations learned by the workshop presentation.

V. Conclusion and Closing Comments

1. Dialogue about observations and feelings during both rides.
2. Evaluation of workshop.

jc
3/6/79

Guidelines for Handling a Manual Wheelchair

FOLDING A WHEELCHAIR

Remove any seat cushions. Lift footrests. Stand next to the chair and pull upward on the seat fabric at the center front and back. Never lift a wheelchair by the armrests. If a chair has removable armrests, they will become unattached.

OPENING A WHEELCHAIR

Keep your fingers turned toward the middle of the seat and press with the heels of the hand on the sides of the seat. Never put your fingers between the chair and frame and the seat.

TAKING A WHEELCHAIR DOWN A CURB

Turn the wheelchair so the back of the chair is toward the curb. Lower the back wheels to ground level, then lower the front wheels.

The second way to take a wheelchair down a curb is to place your foot on the tipping lever - see wheelchair diagram - (1). and take firm hold of the handgrips, then tip the chair backward. Gently lower the chair down the curb. You must now take some of the weight, so be sure to arch your back and bend your knees.

It is very important that both rear wheels hit the ground at the same time.

TAKING A WHEELCHAIR UP A CURB

Place your foot on the tipping lever and lift the chair off its front wheels, moving them forward onto the curb. Gauge the distance to the curb carefully; avoid forcing the front wheels against any ridge or unevenness. Lift the rear wheels up onto the curb and push the chair forward.

TAKING A WHEELCHAIR DOWN STEPS

Don't attempt to take a wheelchair down steps unless you are absolutely sure that you can hold the weight of the person and maintain full control of the chair. Grasp handgrips, slowly move the chair forward, control the forward and downward movement against the step's edge. Use your body as a brake at the top of the step. Don't wait until the chair drops to do so. Repeat the above procedure as often as needed.

TAKING A WHEELCHAIR UP STEPS

Position the wheelchair squarely at the foot of the steps with its back toward the steps. Tip the chair backward. Take a firm grip, place one foot up on the first step, throw the same shoulder slightly backward and pull the chair up onto the step. Repeat the above procedure as often as needed.

TAKEN FROM THE SOURCE BOOK FOR THE DISABLED

ADDITIONAL SUGGESTIONS FOR HANDLING A MANUAL WHEELCHAIR

DETACHING LEGRESTS/FOOTRESTS FROM WHEELCHAIR

See (2) on wheelchair accessories page - lift lever upward and release footrest. Turn footrest outward and lift from mounts.

PUTTING LEGRESTS/FOOTRESTS ON WHEELCHAIR

Match mounts and mount holes on wheelchair. Swing footrest inward until they lock in place. You will hear a clicking sound.

OPERATING ELEVATING LEGRESTS

See (3) on wheelchair accessories page - to lower legrests, push the lever down. - to raise legrest, lift the entire legrest upward.

BRAKES

See (4) on wheelchair accessories page - the lever type brake can be placed in an on position by pulling the lever forward and resting it in the desired slot. To release brake, push the lever backward and rest it in the last available slot.

See (5) on wheelchair accessories page - the toggle type brake can be placed in an on position by pulling the lever forward until a slight clicking sound is heard. To unlock, push the lever backward until it can no longer be moved.

REMOVING ARMRESTS ON WHEELCHAIR

See (6) on wheelchair accessories page - some wheelchairs are equipped with removal desk type armrests. To remove an armrest, push the pin inward and lift the armrest out of the slots. See (7) on wheelchair accessories page.

To put armrests back, match the armrest up with the slots. Push the armrest down until it locks in place. Do not force the armrest into place. If it armrest becomes jammed, pull it out and start over. When the armrest locks in place, the pin will pop into view.

Wheelchairs

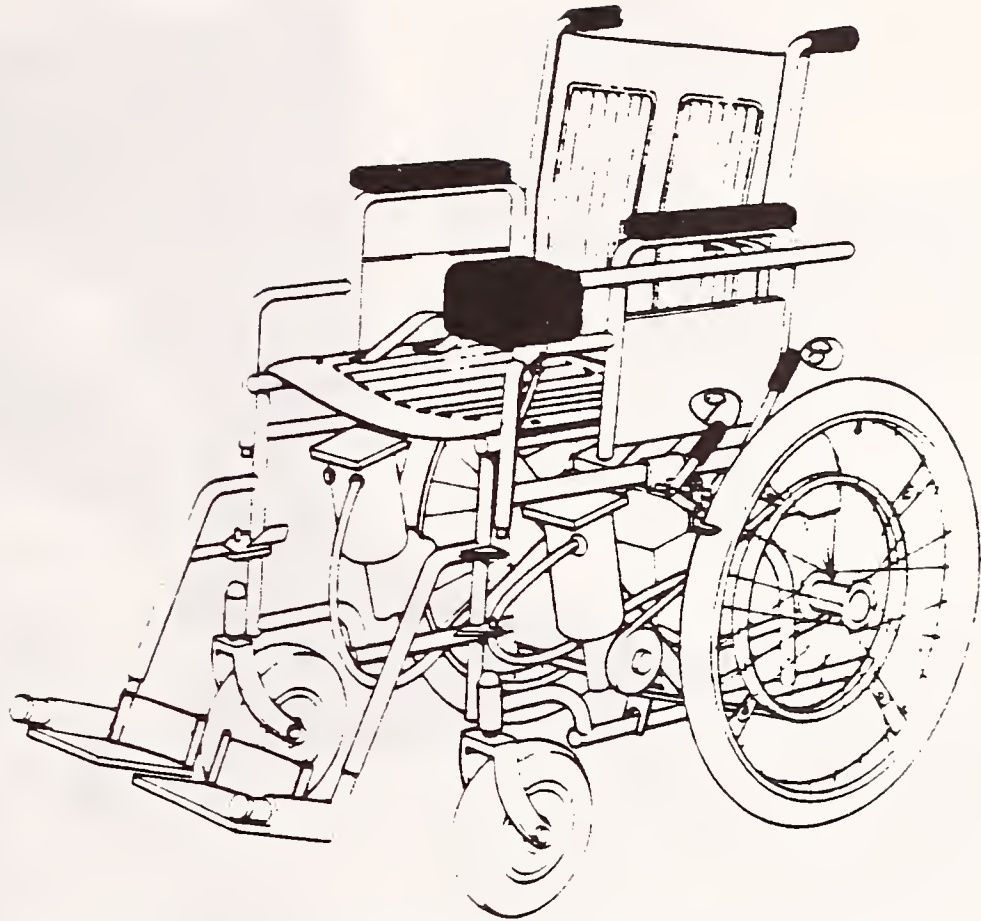

DIRECTIONS FOR ALLOWING AN ELECTRIC WHEELCHAIR TO BE OPERATED MANUALLY

At times it may become necessary to operate an electric wheelchair manually. If the wheelchair is similar to the one on this page, there is a lever on the side of the frame which disengages the gears. See (8) on this page. Pull the lever forward. This will enable the wheelchair to be moved manually. In order to allow the wheelchair to be powered by the battery again, push the lever backward.

NEVER ATTEMPT TO MANUALLY OPERATE AN ELECTRIC WHEELCHAIR WITHOUT PULLING THE LEVER FORWARD. FAILURE TO DO THIS CAN CAUSE PERMANENT DAMAGE TO THE WHEELCHAIR.

THE BRAKES ON ELECTRIC WHEELCHAIRS SIMILAR TO THE ONE ON THIS PAGE ARE LOCATED DIRECTLY IN FRONT OF THE LARGE WHEELS. SEE (9) ON THIS PAGE.

Wheelchairs

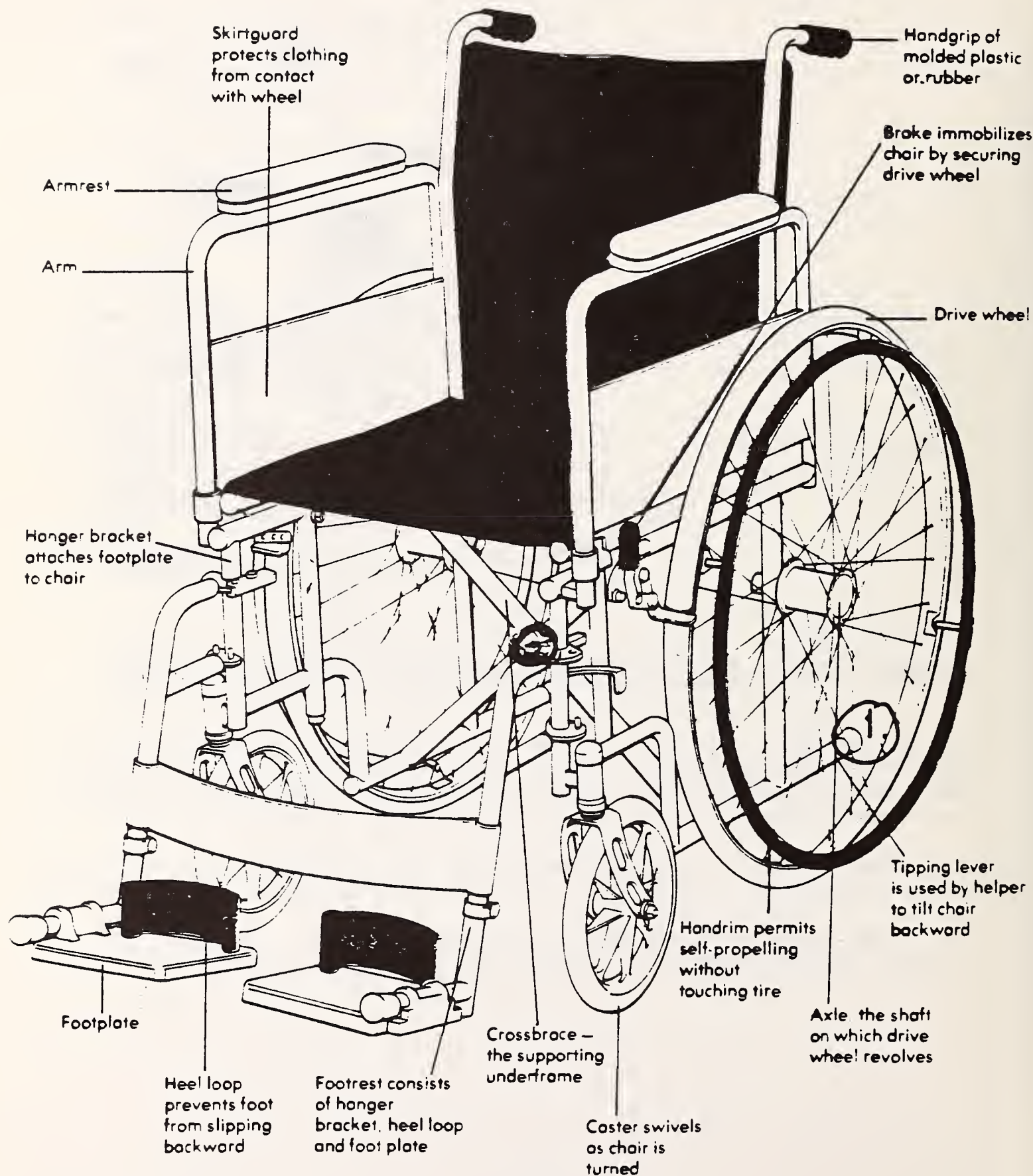

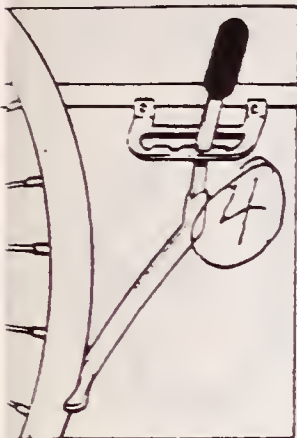

Lever-type wheelchair brakes above can be turned on, off or in a partially on position.

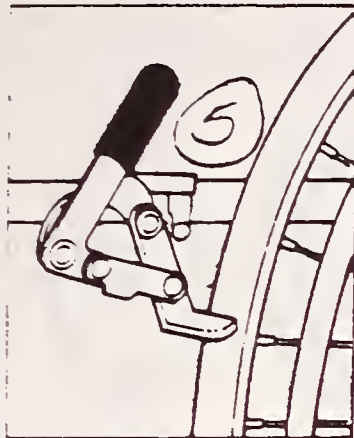

The toggle-type brake above has only the on and off positions which helps to reduce acceleration. The toggle-type brake above has only the on and off positions

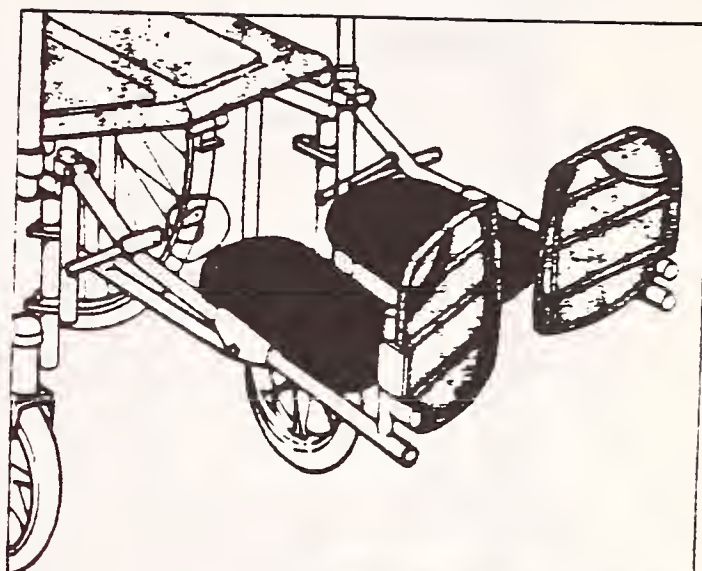

Elevated leg rests are available for people who must keep their legs up. They are made in detachable, swing-away models. The angle can be adjusted to suit the individual. To protect the calves, adjustable, padded calf panels are provided.



Full-length armrests give about fifteen inches (38 cm) of support to the forearms.

6 Desk arms enable the chair to be wheeled under a desk or a table.

Detachable, wrap-around arms—full-length, desk or adjustable—are space-savers

Some sportsman's models have sloping wraparound arms

Adjustable armrests, available in full-length, desk and wraparound styles, can be raised or lowered as required

VARIOUS TYPES OF ARMRESTS

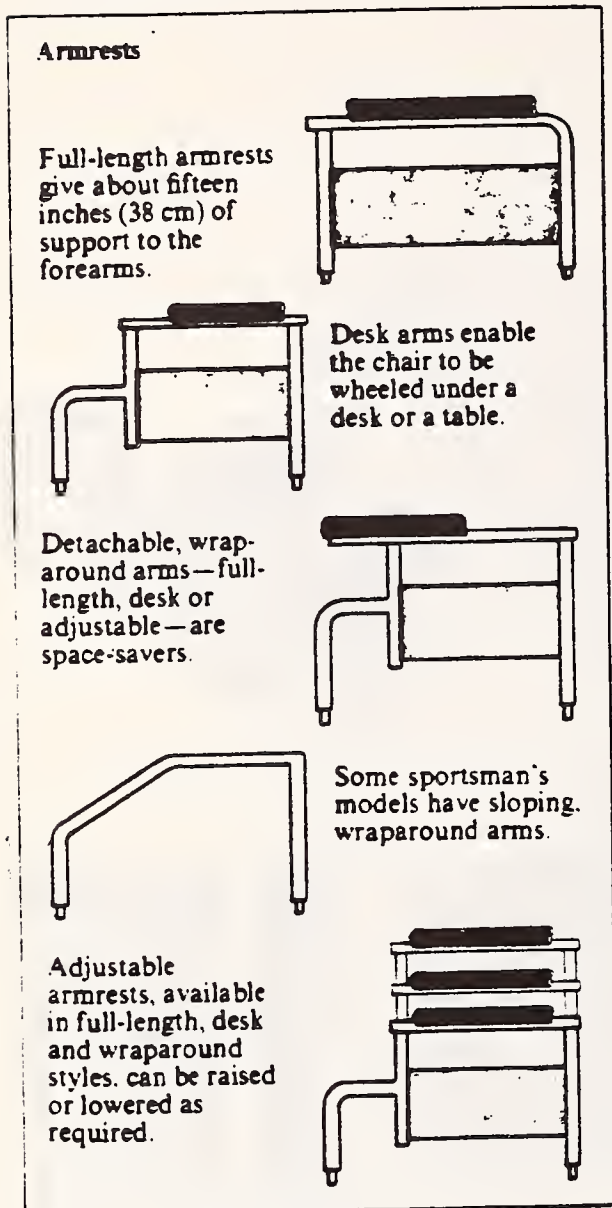

VARIOUS TYPES OF HANDRIMS

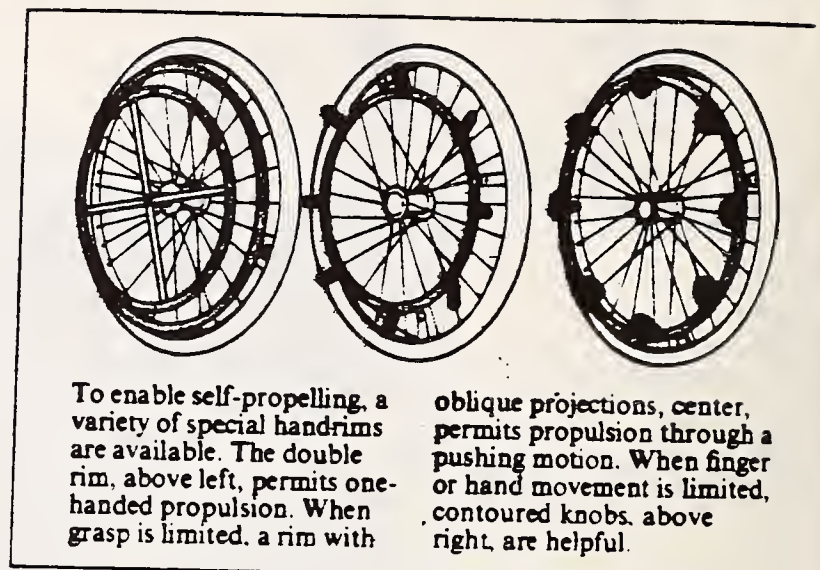

ELEVATED LEGRESTS

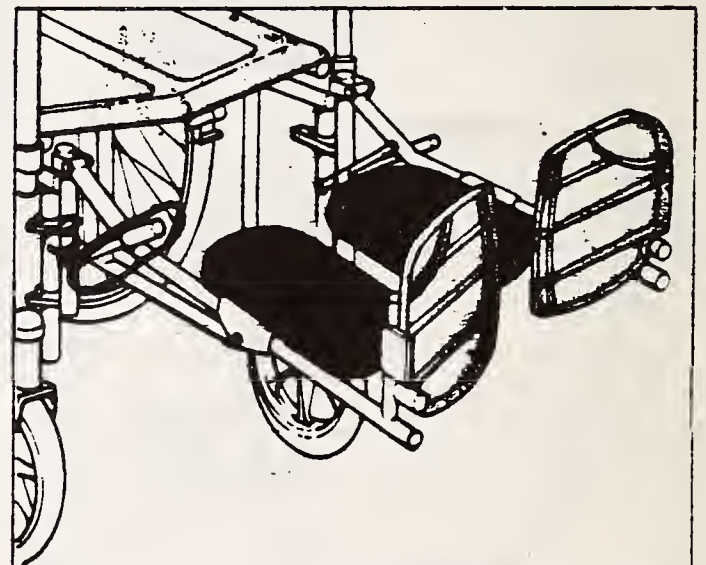

BRAKES

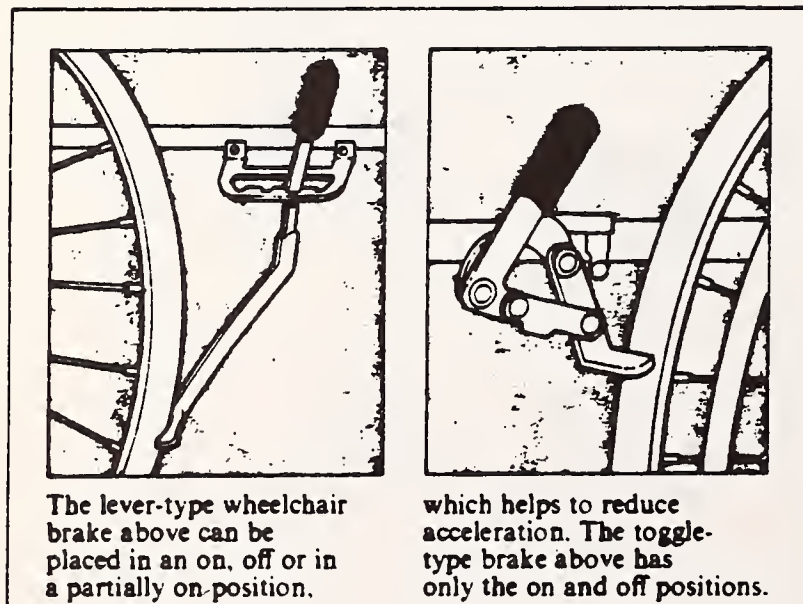

Elevated leg rests are available for people who must keep their legs up. They are made in detachable, swing-away models. The angle can be adjusted to suit the individual. To protect the calves, adjustable, padded calf panels are provided.





Certificate

In recognition that

has attended a Driver Sensitivity Training
Workshop Session comprising a total of _____ hours
of instruction presented _____ day of _____, 19

Manager, ACCESS Transportation Systems, Inc.

Workshop Facilitator, United Cerebral Palsy

October 5, 1981

Thank you for giving up a Saturday morning to attend the ACCESS Driver Training Program. I hope that the morning provided you with some information that will make your difficult job a little easier.

Good drivers are what really make the ACCESS service a success. A thoughtful, sensitive driver will put a passenger at ease, a polite driver will make a late vehicle easier to bear. ACCESS appreciates the extra effort it takes for you to provide the special service that we offer.

Remember that we are here to help you too. If you have questions about the ACCESS system, please feel free to call. You will receive our newsletter, the ACCESS EXPRESS every month, and it should keep you well informed of any changes in the service.

Once again, thanks for attending the session, and keep up the good work!

Sincerely,

Karen Hoesch
Assistant Manager

KH/jmc
enclosure

APPENDIX C. PROMOTIONAL MATERIALS SENT BY ACCESS TO AGENCIES



April 23, 1982

Mr. David Engle
Allegheny County Planning Department
1300 Allegheny Building
429 Forbes Avenue
Pittsburgh, Pennsylvania 15219

Dear David:

As ACCESS enters its fourth year of service, planners, providers and consumers are solidly in agreement as to its success. Both the scope and effectiveness of the service and the public's response to ACCESS have exceeded initial expectations and have made ACCESS one of the model paratransit programs in the United States.

The concept for the ACCESS program was developed locally by the joint efforts of the community, the Port Authority and SPRPC. Door-to-door transportation was seen as the most viable option for the Allegheny County area with its hilly terrain and inclement weather. The concept of a brokerage to provide service by using existing carriers was fairly unique, but made sense in Allegheny County because of the large number of qualified providers with a history of serving the elderly and handicapped. Coordination of the 7 original carriers was originally seen as a challenge - especially with non-profit and for-profit, union and non-union companies working closely together.

Allegheny County was chosen as a demonstration site by UMTA, and the ACCESS program was established in March, 1979, operating under a 3-year demonstration grant. The major objectives of the program were:

1. To provide an affordable alternative means of transportation to elderly and handicapped persons who are not physically able to use fixed route PAT service.
2. To make a uniformly high quality of service available throughout the county. By controlling service quality through central management, ACCESS has more power to enforce service standards and resolve problems than a single agency or consumer.
3. To set up a framework for aggregating the demands of various social service agencies. By centrally coordinating trips, there is less duplication of service and more ride sharing, thus reducing the cost to the agency.

Mr. David Engle
April 23, 1982
Page Two

4. To reduce costs to elderly and handicapped riders by promoting ride-sharing and passing through a substantial, PAT sponsored 75% discount fare to eligible individuals.

A special feature of the ACCESS system is the opportunity for non-ambulatory and semi-ambulatory persons to travel at a reduced cost. For those individuals who are unable to board a bus by virtue of their disability, the Port Authority provides a 75% fare discount. Persons gain eligibility for this subsidy by undertaking a simple certification procedure administered by a licensed physical therapist at the Easter Seal Society under contract to ACCESS.

The ACCESS system allows payment for service in one of two ways. Individuals may buy scrip tickets from ACCESS which are given to the driver as a fare. Agencies may also set up billing accounts with ACCESS for trips which are authorized by agency staff. Agencies are invoiced on a monthly basis for service provided.

Service Characteristics

- o Service available 7 days per week, 6 AM - midnight
- o No restriction on type, length or number of trips
- o Available throughout Allegheny County (729 sq. mi.)
- o Door-to-door service - Drivers provide assistance entering and leaving vehicle and up or down as many as 4 steps.
- o Advance reservations required
- o Riders pay with scrip; fares are pre-determined

ACCESS also improved the quality of service available by:

1. Increasing level of insurance coverage required, well above PUC limit.
2. Implementing a half-day driver training program which all regular ACCESS drivers must complete. The program puts heavy emphasis on understanding the nature of various disabilities and on sensitivity training.
3. Maintaining vehicle accessibility and safety standards, and enforcing them by on-going vehicle inspections.

4. Acting as ombudsman and advocate for elderly and handicapped clients. Service related problems are handled through the central ACCESS office where staff articulates needs of passengers to the carrier and arranges backup service as necessary. Complaints are also documented and pursued to a satisfactory resolution.

The following statistics highlight the growth of the ACCESS program:

- o Chosen as demonstration site by UMTA - March 79 - March 82
Operated under UMTA demonstration grant. Now completely sponsored by PAT, but operate independently.
- o Currently average 16,000 trips per month
- o Nearly 200,000 trips per year
- o Over 3,000 individuals registered for PAT 75% discount
- o 11 carriers in system
- o Average trip length 4.8 miles
- o Average out-of-pocket cost to ACCESS rider - \$1.20 one way.
- o 60% of ACCESS trips for work or education
- o No restrictions on type, number or length of trips
- o 36 Agencies currently purchase service from ACCESS, including AS/AAA, largest purchaser
- o 60% of trips are purchased by individuals, 40% purchased by agencies
- o 1979 - 6,000 (Average) trips per month
- o 1980 - 10,000 (Average) trips per month
- o 1981 - 13,000 (Average) trips per month
- o 1982 - 16,000 (Average) trips per month
- o New carriers added - originally had 7, now have 11
- o Individual usually has to wait less than 15 minutes for vehicle

Mr. David Engle
April 23, 1982
Page Four

By continuing to work closely with elderly and handicapped consumers, ACCESS has been able to greatly increase the responsiveness of the service, and make the system more comparable to fixed-route service.

- o Hours were extended from original 6:30 AM - 10:30 PM to 6:00 AM - midnight
- o Weekend service was added
- o Reservation periods were shortened; consumers have the option of calling on a same day basis with as little as 2 hours advance notice for transportation.

As of April 1, 1982, the UMTA grant expired == PAT assumed the full responsibility for the ACCESS system and is now operated as an integral part of PAT's family of services. The ACCESS system has proved beyond any doubt that by working closely with elderly and handicapped consumers, an accessible transportation system has been developed that disabled consumers can really participate in and use to the fullest extent. Its strong base in the community has been one of the greatest strengths of the ACCESS system.

PAT continues to be committed to providing a high level of service to elderly and handicapped residents of Allegheny County. The new LRV system will be fully accessible as will the Mon Incline with its planned modifications. Over the past 2 years, PAT has added accessibility features to its fixed route-fleet including new lighting, handrails, more readable origin/destination signs and kneeling features. Both the Wood Street and Manchester offices have been made more accessible, and TTY service has been added. In addition, all PAT drivers attend extensive sensitivity training programs.

Both ACCESS and PAT look forward to the continued challenge of providing service, and to working with Pittsburgh's elderly and handicapped community to make ACCESS as responsive to local needs as possible.

Let me know how plans are shaping up for ACCESS week, and if I can be of additional assistance.

Thanks, as always, for your cooperation and support of the ACCESS system.

Sincerely,



Karen Hoesch
Assistant Manager

KH/jmc



THE ACCESS SERVICE-- AN OVERVIEW

ACCESS is a door-to-door, advance reservation, shared-ride transportation service for elderly and handicapped persons in Allegheny County, Pennsylvania. It is sponsored by the Port Authority of Allegheny County (PAT) and funded by a demonstration grant from the Urban Mass Transportation Administration under the Service and Methods Demonstration Program. ACCESS services are managed by a "broker", ACCESS Transportation Systems, Inc., who is charged with the responsibility of organizing and managing service delivery, and of coordinating the demands of individuals and agencies for this service.

ACCESS was designed to fulfill four major objectives. First, it was intended to provide an alternative means of transportation to elderly and handicapped persons who are not physically able to use the fixed-route PAT transit services. Door-to-door service is the only practical way to transport most non-ambulatory and many semi-ambulatory persons, particularly in the Pittsburgh area which is dominated by steep hills and severe winter weather. Second, it aimed to make a uniformly high quality service available throughout the county. By controlling service quality through central management, ACCESS has more power to enforce service standards and to resolve problems than a single agency or consumer.

Third, it set up a framework for aggregating the demands of various social service agencies. Through central coordination, transportation services can be scheduled more efficiently, with less duplication and a lower cost. Fourth, it sought to reduce costs to elderly and handicapped riders by promoting ride-sharing and by offering an alternative to paying exclusive-ride taxi rates.

ACCESS transportation services are provided through the use of vehicles operated by private carriers, including taxi companies and non-profit agencies, under contract to ACCESS Transportation Systems, Inc. These carriers, of which there are now seven, are responsible to the broker for providing service and meeting service standards as specified in their ACCESS contracts. The broker, in turn, pays for service delivered on the basis of a negotiated hourly rate or on the basis of the metered fare. In general, service provided with vans (most with lifts) is contracted on an hourly basis, while service by taxi cabs is on a metered basis.

ACCESS carriers were selected on the basis of their capability and interest in serving the specialized transportation market in Allegheny County. Carrier responsibilities are clearly delineated, in geographic terms and in terms of the type of service offered, so that there is no conflict between carriers, particularly between for-profit and non-profit carriers.

The process for selecting ACCESS carriers was implemented in three stages. First, ACCESS made a public solicitation for Qualifications Statements from potential carriers. All known existing carriers who might be

The ACCESS Service: An Overview

November 6, 1980

Page Two

interested were personally solicited in addition to the public notice. Based on the responses received, carriers were selected as qualified for further consideration.

A request for a competitive price bid was sent to the for-profit carriers; a request for a cost statement was sent to the non-profit organizations. Carriers negotiate new contracts yearly, and each year, ACCESS attempts to solicit interest from new potential carriers.

ACCESS offers service between the hours of 6:30 A.M. and 10:30 P.M., Monday-Sunday, including holidays. The service is available throughout Allegheny County, which covers 729 sq. mi. There are no trip purpose restrictions, or any restrictions on trip length or number of trips which can be requested by an agency or an individual.

The ACCESS system utilizes a zone-based fare schedule which subdivides the county into 195 zones and computes fares on the basis of airline distance between zone centroids. Current fares amount to a minimum charge of \$2.00 and a charge of \$1.25 per airline mile for trips between zones. The fare represents the complete user charge; riders do not pay any additional time or mileage charges and are not required to tip. This fare structure enables carriers to quote fares to riders before they take their trip. Agencies which schedule trips through ACCESS for their clients are also charged on the basis of this fare structure. In addition, ACCESS offers special group rates for pre-grouped trips arranged in advance by individuals or agencies.

A special feature of the ACCESS system is the opportunity for non-ambulatory and semi-ambulatory persons to travel at a reduced cost. For those individuals who are unable to board a bus by virtue of their disability, the Port Authority provides a 75% fare discount. Persons gain eligibility for this subsidy by undertaking a simple certification procedure administered by a licensed physical therapist at the Easter Seal Society under contract to ACCESS.

The ACCESS system allows payment for service in one of two ways. Individuals may buy scrip tickets from ACCESS which are given to the driver as a fare. Agencies may also set up billing accounts with ACCESS for trips which are authorized by agency staff. Agencies are invoiced on a monthly basis for service provided.

At the present time, 36 agencies are purchasing service through the ACCESS system, including Adult Services of Allegheny County which is the local Area Agency on Aging. AS/AAA is the largest single purchaser of transportation services for the elderly in Allegheny County. Of the 14,000 passenger trips provided by ACCESS in the month of October, about 60% of these are billed to a third party, while 40% are purchased by individual riders.

The ACCESS Service: An Overview

November 6, 1980

Page Three

ACCESS has also been instrumental in improving the quality of transportation services available to handicapped and elderly residents of Allegheny County. Prior to ACCESS, many carriers had only the bare minimum of insurance coverage required by the Public Utility Commission. ACCESS raised all its carriers' limits substantially and also purchased an excess liability policy covering itself and the Port Authority well beyond the increased limits.

ACCESS also implemented a half-day driver training program which all regular ACCESS drivers must complete. The program puts heavy emphasis on understanding the nature of various disabilities and on sensitivity training.

A related program which ACCESS has also instituted is an on-going vehicle inspection program. ACCESS carrier contracts stipulate minimum standards for vehicles and these standards are being enforced by on-site inspections and detailed follow-up efforts.

ACCESS also plays an important role for the consumer as "ombudsman." Lost calls, vehicle delays and other service related problems are handled through the central ACCESS office where the staff articulates the needs of the passenger to the carrier and arranges back-up service as necessary. In addition, all service-related complaints are documented and followed up in Writing, both to the carrier and the passenger, and pursued until there is a satisfactory resolution.

In addition to this service, the ACCESS office provides consumers information about transportation services available locally and nationally. From this activity has evolved a comprehensive guide to transportation services available in Allegheny County which is distributed free of charge to agencies and individuals. The guide is updated each year. ACCESS also provides users with a monthly newsletter which has items of interest to elderly and handicapped consumers as well as providing information to the consumer about the ACCESS service. Consumers are actively involved in the planning and development of the ACCESS service, both through the Elderly and Handicapped Advisory Committee of the Southwestern Pennsylvania Regional Planning Commission and the ACCESS Task Force.

ACCESS will continue to make its service as responsive as possible to the needs of elderly and handicapped persons. The future may bring such changes in the service such as shorter reservation periods, and increased levels of coordination and productivity throughout the system.

APPENDIX D. HUMAN SERVICE AGENCY SURVEYS

SURVEY OF AGENCIES AFFILIATED WITH ACCESS

Please Note:
This Column
Is For Use
In Survey
Tabulation.

Part 1: QUESTIONS ABOUT YOUR AGENCY

PLEASE ANSWER THE FOLLOWING QUESTIONS ABOUT YOUR AGENCY AND ITS CLIENTS.

1
1

Agency Name: _____
Address: _____
Telephone: _____
Contact Person: _____ Title: _____

2 3 4

1. Is your agency affiliated with other Allegheny County human service agencies?

5

1. _____ No
2. _____ Yes → Which Agencies? _____

6 7

2. Which of the following would best describe your organization?
(Please check the one that applies.)

8

1. _____ Private, for profit 3. _____ Public
2. _____ Private, not-for-profit 4. _____ Other (Please specify)

3. What are the major funding sources of your agency and what percentage of total agency funds comes from each source?

<u>Funding Source</u>	<u>Percentage of agency funds</u>	
_____	_____	9 10
_____	_____	11 12
_____	_____	13 14
_____	_____	15 16
_____	_____	17 18
All Sources	100 %	

4. What type of clients does your agency serve? (Please check all that apply.)

- | | | | | |
|----|-------|-------------------------------|----|----|
| 1. | _____ | Elderly | 23 | 24 |
| 2. | _____ | Physically Handicapped | 25 | 26 |
| 3. | _____ | Mentally Handicapped | 27 | 28 |
| 4. | _____ | Others (Please Specify) _____ | 29 | 30 |
| | | _____ | | |
| | | _____ | | |

5. What type of services does your agency provide? (Please check all that apply.)

- | | | | | | | | |
|----|-------|-------------------|----|-------|-------------------------|----|----|
| 1. | _____ | Counseling | 5. | _____ | Physical Rehabilitation | 31 | 32 |
| 2. | _____ | Group Meals | 6. | _____ | Vocational Training | 33 | 34 |
| 3. | _____ | Recreation/Social | 7. | _____ | Economic Assistance | 35 | 36 |
| 4. | _____ | Education | 8. | _____ | Other (Please specify.) | | |
| | | | | | _____ | | |

6. Approximately how many clients does your agency currently serve?

_____ clients

31 32 33

7. What percentage of these clients use agency services at least once a week?

34 35

_____ percent

8. What requirements must individuals meet to be served by your agency?
(Please check all that apply.)

36 37

1. _____ They must be over age _____. (Please fill in.)

38 39

2. _____ They must meet specific income guidelines.

3. _____ They must be physically or mentally handicapped.

40 41

(Please describe type of handicap, if any) _____

4. _____ They must live in a specific area.

42 43

5. _____ They must be of a particular religious faith.

6. _____ They must be of a particular profession.

7. _____ They must be referred by another agency.

8. _____ No requirements for clients.

9. _____ Other requirements. (Please specify.) _____

9. What percentage of your clients are ambulatory and what percentage require the use of a wheelchair?

_____ percent are ambulatory.

44 45

_____ percent require the use of a wheelchair.

46 47

Part 2: QUESTIONS ABOUT THE AGENCY'S TRANSPORTATION SERVICES

PLEASE ANSWER THE FOLLOWING QUESTIONS ABOUT THE TRANSPORTATION SERVICES PROVIDED BY YOUR AGENCY

10. Does your agency provide transportation to clients in any of the following ways?

Operate agency vehicles?	1. <input type="checkbox"/>	Yes	2. <input type="checkbox"/>	No	48
Purchase transportation services?	1. <input type="checkbox"/>	Yes	2. <input type="checkbox"/>	No	49
Use volunteers or staff who drive their own vehicles?	1. <input type="checkbox"/>	Yes	2. <input type="checkbox"/>	No	50
Reimburse clients for transportation expenses?	1. <input type="checkbox"/>	Yes	2. <input type="checkbox"/>	No	51

11. Are you able to serve all your clients' requests for service?

1. Yes
2. No → Why not? (Please explain.)
- _____
- _____

12. Are decisions concerning the agency's transportation services made at the agency?

1. Yes
2. No → Who makes transportation decisions for the agency?
- _____
- _____

13. Considering all carriers and vehicles, for what purposes does your agency provide transportation? (Check all that apply.)

1. Travel to group-meal sites
2. Travel to medical appointment, physical rehabilitation, etc.
3. Travel to group social outings and events
4. Travel to employment
5. Travel for shopping purposes
6. Travel to educational classes
7. The agency provides transportation for all purposes
8. The agency provides transportation for other purposes. (Please list these.)
- _____
- _____
- _____

14. Does your agency own or operate any vehicles?

1. _____ Yes
2. _____ No → PLEASE SKIP TO QUESTION 24 AND CONTINUE SURVEY.

61

15. How many vehicles does your agency own or operate?

_____ vehicles (Please fill in number.)

62 63

16. How many of these vehicles are ramp or lift equipped?

_____ vehicles (Please fill in number.)

64 65

17. Are advance reservations required for transportation services in agency vehicles?

1. _____ No
2. _____ Yes → How far in advance? _____ hours

66

67 68

18. Please complete the following sentences by filling in the number of each type of vehicle owned or operated by your agency.

69 70

The agency owns or operates _____ sedans.

71 72

The agency owns or operates _____ vans.

The agency owns or operates _____ buses.

73 74

19. Of the vehicles that your agency owns or operates, how many does the agency own?

75 76

_____ vehicles

2
1

2 3 4

20. Where did your agency obtain funds to purchase any or all of these vehicles? (Please check as many as apply.)
- | | | | | |
|----|--------------------------|---------------------------------|----------|-----------|
| 1. | <input type="checkbox"/> | Federal Section 16(b)(2) grants | <u>5</u> | <u>6</u> |
| 2. | <input type="checkbox"/> | General agency funds | <u>7</u> | <u>8</u> |
| 3. | <input type="checkbox"/> | State funds | <u>9</u> | <u>10</u> |
| 4. | <input type="checkbox"/> | County funds | | |
| 5. | <input type="checkbox"/> | Local (city or town) funds | | |
| 6. | <input type="checkbox"/> | Other (Please describe) _____ | | |

21. Who owns the vehicles, if any, that your agency operates but does not own?
- _____
- _____

22. Are there any restrictions on your agency's use of any of its vehicles?
1. No
2. Yes → What are these restrictions?
- _____
- _____

23. For what purposes does your agency use its own vehicles? (Please check all that apply.)
- | | | | | |
|----|--------------------------|---|-----------|-----------|
| 1. | <input type="checkbox"/> | Transport clients to group meal sites | <u>14</u> | <u>15</u> |
| 2. | <input type="checkbox"/> | Transport clients to medical appointment, physical rehabilitation centers, etc. | <u>16</u> | <u>17</u> |
| 3. | <input type="checkbox"/> | Transport clients to group social outings and events | <u>18</u> | <u>19</u> |
| 4. | <input type="checkbox"/> | Transport clients to their jobs | | |
| 5. | <input type="checkbox"/> | Transport clients to educational classes | | |
| 6. | <input type="checkbox"/> | Transport clients for shopping purposes | | |
| 7. | <input type="checkbox"/> | Other client activities (Please describe.) _____ | | |
8. The agency does not use its own vehicles to transport clients.

24. Does your agency purchase transportation services from providers other than ACCESS either directly or through a central agency such as AS/AAA? (ACCESS is the shared-ride transportation system sponsored by the Port Authority of Allegheny County.)
1. Yes
2. No → PLEASE SKIP TO QUESTION 29 AND CONTINUE SURVEY.

25. From which carrier or carriers does your agency purchase service?
(Please check all that apply but do not include carriers that you use
only through a contract with ACCESS.)

21 22

- | | | | |
|-----------------------------|---|--|------------------|
| 1. <input type="checkbox"/> | Yellow Cab | 6. <input type="checkbox"/> | Diamond Cab |
| 2. <input type="checkbox"/> | Tube City Taxi | 7. <input type="checkbox"/> | People's Cab |
| 3. <input type="checkbox"/> | Colonial Taxi | 8. <input type="checkbox"/> | Tri-Borough Taxi |
| 4. <input type="checkbox"/> | Magic Carpet | 9. <input type="checkbox"/> | Others |
| 5. <input type="checkbox"/> | North Hills
Transportation
Services | (Please specify carriers.)

_____ | |

23 24

26. Are advance reservations required for service by this carrier(s)?

1. No
2. Yes → How far in advance? _____ hours.

25

27. Approximately how much does your agency pay on average for a one-way
client trip provided by these carriers?

26 27

\$ _____ per one-way trip

28 29 30 31

28. How is your agency charged for service from these carriers?

1. Agency is charged a pre-determined price for each trip.
2. Agency is charged the metered fare.
3. Agency is charged for service on a per-hour basis
4. Other (Please describe) _____

32

29. Approximately how many one-way trips per week does your agency
provide for its clients. (Please fill in the blanks.)

using carriers other than ACCESS? _____ one-way trips per week
using ACCESS? _____ one-way trips per week
using agency-owned or operated vehicles? _____ one-way trips per
week

33 34 35

36 37 38

39 40 41

30. Approximately what percentage of all trips provided by your agency are
groups trips (i.e., organized groups of 2 or more persons)?

42 43

_____ percent are group trips.

31. How much, if anything, does your agency charge its clients for transportation services?

44 45 46

\$ _____ per one-way trip

32. Approximately how much did your agency spend in 1981 on transportation services for its clients?

47 48 49 50 51 52

\$ _____

33. Approximately what percentage is this of the total agency budget?

53 54

_____ percent

34. How much does the agency expect to spend on transportation services in 1982?

55 56 57 58 59 60

\$ _____

35. We are interested in the days and times during which your agency provides trips for its clients. Please indicate on the spaces below approximately the number of agency trips made during the following time periods this week.

TIME PERIOD	DAY OF THE WEEK						
	Sunday	Monday	Tuesday	Wednesday	Thursday	Friday	Saturday
7:00 a.m.-9:00 a.m.	_____	_____	_____	_____	_____	_____	_____
9:00 a.m.-2:00 p.m.	_____	_____	_____	_____	_____	_____	_____
2:00 p.m.-5:00 p.m.	_____	_____	_____	_____	_____	_____	_____
5:00 p.m.-7:00 p.m.	_____	_____	_____	_____	_____	_____	_____
After 7:00 p.m.	_____	_____	_____	_____	_____	_____	_____

Part 3 AGENCY EXPERIENCE WITH ACCESS

PLEASE ANSWER THE FOLLOWING QUESTIONS ABOUT YOUR EXPERIENCES WITH ACCESS.

36. For what trip purposes does your agency use ACCESS service?
(Please check all that apply.) 61 62
- | | | | |
|--|---|----|----|
| 1. <input type="checkbox"/> All trips | 5. <input type="checkbox"/> Social/recreational | 63 | 64 |
| 2. <input type="checkbox"/> Nutrition | 6. <input type="checkbox"/> Education | 65 | 66 |
| 3. <input type="checkbox"/> Medical | 7. <input type="checkbox"/> Grocery shopping | 67 | 68 |
| 4. <input type="checkbox"/> Training or employment | 8. <input type="checkbox"/> Other purposes (Please describe.) _____ | | |

37. Has the agency had any difficulties with ACCESS' third-party billing procedures? (Please check one.) 69
1. No difficulties.
2. Minor difficulties that have been resolved satisfactorily.
3. Major difficulties that have already been resolved.
(Please describe.) _____

4. Difficulties that have not yet been resolved.
(Please describe.) _____

3
1

2 3 4

38. What transportation providers or services did the agency use for the majority of its trips before contracting with ACCESS? (Please check one.)

5

- | | | | |
|-----------------------------|----------------------|-----------------------------|-------------------------|
| 1. <input type="checkbox"/> | Used agency vehicles | 6. <input type="checkbox"/> | Diamond Cab |
| 2. <input type="checkbox"/> | Magic Carpet | 7. <input type="checkbox"/> | People's Cab |
| 3. <input type="checkbox"/> | Yellow Cab | 8. <input type="checkbox"/> | Tri-Borough Taxi |
| 4. <input type="checkbox"/> | Tube City Taxi | 9. <input type="checkbox"/> | Other (Please specify.) |
| 5. <input type="checkbox"/> | Colonial Taxi | | _____ |
| | | | _____ |

39. Which ACCESS carrier does the agency use for the majority of its ACCESS trips? (Please check one.)

6 7

- | | | | |
|-----------------------------|------------------------|------------------------------|---------------------------|
| 1. <input type="checkbox"/> | Magic Carpet | 7. <input type="checkbox"/> | The Center |
| 2. <input type="checkbox"/> | Yellow Cab | 8. <input type="checkbox"/> | Chartiers |
| 3. <input type="checkbox"/> | Tube City Taxi | 9. <input type="checkbox"/> | Tri-Borough Taxi |
| 4. <input type="checkbox"/> | Colonial | 10. <input type="checkbox"/> | North Hill Transportation |
| 5. <input type="checkbox"/> | Focus on Renewal | | Services |
| 6. <input type="checkbox"/> | Steelworkers Oldtimers | 11. <input type="checkbox"/> | Amram Enterprises |
| | Foundation | | |

40. Below is a list of ACCESS service characteristics. Please indicate if these characteristics are very useful, somewhat useful, or have no effect.

	(1)	(2)	(3)	
	Very Useful	Somewhat Useful	No	
	<u>To Agency</u>	<u>To Agency</u>	<u>Effect on</u>	
			<u>the Agency</u>	
Monthly ACCESS Accounting Records	_____	_____	_____	<u>8</u>
6:00 A.M.--12:00 P.M. Service	_____	_____	_____	<u>9</u>
Sunday-Saturday Service	_____	_____	_____	<u>10</u>
ACCESS Carrier Insurance	_____	_____	_____	<u>11</u>

41. Below is a second list of ACCESS service characteristics. Please indicate how these service characteristics differ from the service you received before your agency became affiliated with ACCESS.

	(1) Much Better Than Previous Service	(2) Somewhat Better Than Previous Service	(3) The Same As Previous Service	(4) Somewhat Worse Than Previous Service	(5) Much Worse Than Previous Service	
Driver Sensitivity	_____	_____	_____	_____	_____	<u>12</u>
Complaint Procedures	_____	_____	_____	_____	_____	<u>13</u>
Time Spent Waiting for Vehicle to Arrive	_____	_____	_____	_____	_____	<u>14</u>
Time Spent in Vehicle	_____	_____	_____	_____	_____	<u>15</u>
Vehicle Safety	_____	_____	_____	_____	_____	<u>16</u>
Availability of Service When Needed	_____	_____	_____	_____	_____	<u>17</u>
Service Hours	_____	_____	_____	_____	_____	<u>18</u>
Provision of Door-To- Door Service	_____	_____	_____	_____	_____	<u>19</u>
Accessible Vehicles	_____	_____	_____	_____	_____	<u>20</u>

42. Please indicate whether you agree or disagree that the agency has received any of the following benefits from contracting with ACCESS.

	(1) <u>Agree</u>	(2) <u>Disagree</u>	(3) No <u>Opinion</u>	
a) Agency transportation costs have decreased or risen more slowly than they would have without ACCESS.	—	—	—	<u>21</u>
b) The agency receives a similar or higher quality service from ACCESS than it did before.	—	—	—	<u>22</u>
c) The agency is more flexible in the <u>amount</u> of service it can provide for its clients.	—	—	—	<u>23</u>
d) The agency is more flexible in <u>when</u> it can provide service for its clients.	—	—	—	<u>24</u>
e) The agency has been able to use its vehicles more efficiently by using ACCESS to provide single-passenger trips.*	—	—	—	<u>25</u>
f) Scheduling trips is easier than before.	—	—	—	<u>26</u>
g) It is easier to register complaints about service than before.	—	—	—	<u>27</u>
h) Complaints are resolved in a more satisfactory manner than before.	—	—	—	<u>28</u>
i) ACCESS is an important supplement to our other vehicles when a vehicle breaks down or a driver is unavailable.*	—	—	—	<u>29</u>
j) ACCESS can negotiate with carriers more successfully than an individual agency can.	—	—	—	<u>30</u>

*If your agency has no vehicles of its own, please skip over this statement.

Please feel free to elaborate on any of the answers you gave in this survey or to add any thoughts you or others in your organization may have concerning agency transportation.

THANK YOU FOR YOUR COOPERATION!

SURVEY OF AGENCIES NOT AFFILIATED WITH
ACCESS

Please Note:
This Column
Is For Use
In Survey
Tabulation.

Part 1: QUESTIONS ABOUT YOUR AGENCY

PLEASE ANSWER THE FOLLOWING QUESTIONS ABOUT YOUR AGENCY AND ITS CLIENTS.

1
1

Agency Name: _____
Address: _____
Telephone: _____
Contact Person: _____ Title: _____

2 3 4

1. Is your agency affiliated with other Allegheny County human service agencies?

5

1. _____ No
2. _____ Yes → Which Agencies? _____

6 7

2. Which of the following would best describe your organization?
(Please check the one that applies.)

8

1. _____ Private, for profit 3. _____ Public
2. _____ Private, not-for-profit 4. _____ Other (Please specify)

3. What are the major funding sources of your agency and what percentage of total agency funds comes from each source?

<u>Funding Source</u>	<u>Percentage of agency funds</u>	
_____	_____	<u>9 10</u>
_____	_____	<u>11 12</u>
_____	_____	<u>13 14</u>
_____	_____	<u>15 16</u>
_____	_____	<u>17 18</u>
All Sources	100 %	

4. What type of clients does your agency serve? (Please check all that apply.)

- | | | |
|-----------------------------|-------------------------------|-----------|
| 1. <input type="checkbox"/> | Elderly | <u>19</u> |
| 2. <input type="checkbox"/> | Physically Handicapped | <u>20</u> |
| 3. <input type="checkbox"/> | Mentally Handicapped | <u>21</u> |
| 4. <input type="checkbox"/> | Others (Please Specify) _____ | <u>22</u> |
| | _____ | |
| | _____ | |

5. What type of services does your agency provide? (Please check all that apply.)

- | | | | | |
|-----------------------------|-------------------|-----------------------------|-------------------------|--------------|
| 1. <input type="checkbox"/> | Counseling | 5. <input type="checkbox"/> | Physical Rehabilitation | <u>23 24</u> |
| 2. <input type="checkbox"/> | Group Meals | 6. <input type="checkbox"/> | Vocational Training | <u>25 26</u> |
| 3. <input type="checkbox"/> | Recreation/Social | 7. <input type="checkbox"/> | Economic Assistance | <u>27 28</u> |
| 4. <input type="checkbox"/> | Education | 8. <input type="checkbox"/> | Other (Please specify.) | <u>29 30</u> |
| | | | _____ | |

6. Approximately how many clients does your agency currently serve?

_____ clients 31 32 33

7. What percentage of these clients use agency services at least once a week?

34 35

_____ percent

8. What requirements must individuals meet to be served by your agency?
(Please check all that apply.)

36 37

1. _____ They must be over age _____. (Please fill in.)

38 39

2. _____ They must meet specific income guidelines.

3. _____ They must be physically or mentally handicapped.

40 41

(Please describe type of handicap, if any) _____

4. _____ They must live in a specific area.

42 43

5. _____ They must be of a particular religious faith.

6. _____ They must be of a particular profession.

7. _____ They must be referred by another agency.

8. _____ No requirements for clients.

9. _____ Other requirements. (Please specify.) _____

9. What percentage of your clients are ambulatory and what percentage require the use of a wheelchair?

_____ percent are ambulatory.

44 45

_____ percent require the use of a wheelchair.

46 47

Part 2: QUESTIONS ABOUT THE AGENCY'S TRANSPORTATION SERVICES

PLEASE ANSWER THE FOLLOWING QUESTIONS ABOUT THE TRANSPORTATION SERVICES PROVIDED BY YOUR AGENCY

10. Does your agency provide transportation to clients in any of the following ways?

Operate agency vehicles?	1. _____	Yes	2. _____	No	48
Purchase transportation services?	1. _____	Yes	2. _____	No	49
Use volunteers or staff who drive their own vehicles?	1. _____	Yes	2. _____	No	50
Reimburse clients for transportation expenses?	1. _____	Yes	2. _____	No	51

11. Are you able to serve all your clients' requests for service?

1. _____	Yes				52
2. _____	No	→	Why not? (Please explain.)		
<hr/> <hr/>					

12. Are decisions concerning the agency's transportation services made at the agency?

1. _____	Yes				53
2. _____	No	→	Who makes transportation decisions for the agency?		54
<hr/> <hr/>					

13. Considering all carriers and vehicles, for what purposes does your agency provide transportation? (Check all that apply.)

1. _____	Travel to group-meal sites	55	56
2. _____	Travel to medical appointment, physical rehabilitation, etc.	57	58
3. _____	Travel to group social outings and events		
4. _____	Travel to employment		
5. _____	Travel for shopping purposes		
6. _____	Travel to educational classes		
7. _____	The agency provides transportation for all purposes		
8. _____	The agency provides transportation for other purposes. (Please list these.)		
<hr/> <hr/> <hr/>			

14. Does your agency own or operate any vehicles?

1. _____ Yes
 2. _____ No → PLEASE SKIP TO QUESTION 24 AND CONTINUE SURVEY.

61

15. How many vehicles does your agency own or operate?

_____ vehicles (Please fill in number.)

62 63

16. How many of these vehicles are ramp or lift equipped?

_____ vehicles (Please fill in number.)

64 65

17. Are advance reservations required for transportation services in agency vehicles?

1. _____ No
 2. _____ Yes → How far in advance? _____ hours

66

67 68

18. Please complete the following sentences by filling in the number of each type of vehicle owned or operated by your agency.

69 70

The agency owns or operates _____ sedans.

71 72

The agency owns or operates _____ vans.

The agency owns or operates _____ buses.

73 74

19. Of the vehicles that your agency owns or operates, how many does the agency own?

75 76

_____ vehicles

2
1

2 3 4

20. Where did your agency obtain funds to purchase any or all of these vehicles? (Please check as many as apply.)
- | | | | |
|----|--|----------|-----------|
| | | <u>5</u> | <u>6</u> |
| 1. | <input type="checkbox"/> Federal Section 16(b)(2) grants | <u>7</u> | <u>8</u> |
| 2. | <input type="checkbox"/> General agency funds | <u>9</u> | <u>10</u> |
| 3. | <input type="checkbox"/> State funds | | |
| 4. | <input type="checkbox"/> County funds | | |
| 5. | <input type="checkbox"/> Local (city or town) funds | | |
| 6. | <input type="checkbox"/> Other (Please describe) _____ | | |

21. Who owns the vehicles, if any, that your agency operates but does not own?
- _____
- _____

22. Are there any restrictions on your agency's use of any of its vehicles?
1. No
2. Yes → What are these restrictions?
- _____
- _____

23. For what purposes does your agency use its own vehicles? (Please check all that apply.)
- | | | | |
|----|--|-----------|-----------|
| | | <u>12</u> | <u>13</u> |
| 1. | <input type="checkbox"/> Transport clients to group meal sites | <u>14</u> | <u>15</u> |
| 2. | <input type="checkbox"/> Transport clients to medical appointment, physical rehabilitation centers, etc. | <u>16</u> | <u>17</u> |
| 3. | <input type="checkbox"/> Transport clients to group social outings and events | <u>18</u> | <u>19</u> |
| 4. | <input type="checkbox"/> Transport clients to their jobs | | |
| 5. | <input type="checkbox"/> Transport clients to educational classes | | |
| 6. | <input type="checkbox"/> Transport clients for shopping purposes | | |
| 7. | <input type="checkbox"/> Other client activities (Please describe.) _____ | | |

8. The agency does not use its own vehicles to transport clients.

24. Does your agency purchase transportation services from providers other than ACCESS either directly or through a central agency such as AS/AAA? (ACCESS is the shared-ride transportation system sponsored by the Port Authority of Allegheny County.)
1. Yes
2. No → PLEASE SKIP TO QUESTION 29 AND CONTINUE SURVEY.

25. From which carrier or carriers does your agency purchase service?
(Please check all that apply but do not include carriers that you use
only through a contract with ACCESS.)

21 22

- | | | | |
|-----------------------------|---|--|------------------|
| 1. <input type="checkbox"/> | Yellow Cab | 6. <input type="checkbox"/> | Diamond Cab |
| 2. <input type="checkbox"/> | Tube City Taxi | 7. <input type="checkbox"/> | People's Cab |
| 3. <input type="checkbox"/> | Colonial Taxi | 8. <input type="checkbox"/> | Tri-Borough Taxi |
| 4. <input type="checkbox"/> | Magic Carpet | 9. <input type="checkbox"/> | Others |
| 5. <input type="checkbox"/> | North Hills
Transportation
Services | (Please specify carriers.)

_____ | |

23 24

26. Are advance reservations required for service by this carrier(s)?

1. No
2. Yes → How far in advance? _____ hours.

25

27. Approximately how much does your agency pay on average for a one-way
client trip provided by these carriers?

26 27

\$ _____ per one-way trip

28 29 30 31

28. How is your agency charged for service from these carriers?

1. Agency is charged a pre-determined price for each trip.
2. Agency is charged the metered fare.
3. Agency is charged for service on a per-hour basis
4. Other (Please describe) _____

32

29. Approximately how many one-way trips per week does your agency
provide for its clients. (Please fill in the blanks.)

using carriers other than ACCESS? _____ one-way trips per week
using ACCESS? _____ one-way trips per week
using agency-owned or operated vehicles? _____ one-way trips per
week

33 34 35

36 37 38

39 40 41

30. Approximately what percentage of all trips provided by your agency are
groups trips (i.e., organized groups of 2 or more persons)?

42 43

_____ percent are group trips.

31. How much, if anything, does your agency charge its clients for transportation services?

44 45 46

\$ _____ per one-way trip

32. Approximately how much did your agency spend in 1981 on transportation services for its clients?

47 48 49 50 51 52

\$ _____

33. Approximately what percentage is this of the total agency budget?

53 54

_____ percent

34. How much does the agency expect to spend on transportation services in 1982?

55 56 57 58 59 60

\$ _____

35. We are interested in the days and times during which your agency provides trips for its clients. Please indicate on the spaces below approximately the number of agency trips made during the following time periods this week.

TIME PERIOD	DAY OF THE WEEK						
	Sunday	Monday	Tuesday	Wednesday	Thursday	Friday	Saturday
7:00 a.m.-9:00 a.m.	_____	_____	_____	_____	_____	_____	_____
9:00 a.m.-2:00 p.m.	_____	_____	_____	_____	_____	_____	_____
2:00 p.m.-5:00 p.m.	_____	_____	_____	_____	_____	_____	_____
5:00 p.m.-7:00 p.m.	_____	_____	_____	_____	_____	_____	_____
After 7:00 p.m.	_____	_____	_____	_____	_____	_____	_____

Part 3: COORDINATED SERVICES

PLEASE ANSWER THE FOLLOWING QUESTIONS ABOUT COORDINATING YOUR AGENCY'S TRANSPORTATION PROGRAM WITH THE PROGRAMS OF OTHER AGENCIES.

36. Are your transportation services coordinated in any way with the transportation services of other agencies and organizations? (e.g., integrated scheduling or dispatching, vehicle sharing, centralized purchasing of service, centralized maintenance, centralized billing.)

61

- 1. Yes
- 2. No

If yes, please describe _____

Agencies Involved _____

37. Has your agency ever considered purchasing service through ACCESS, Port Authority Transit's shared-ride system?

62

- 1. Yes
- 2. No

38. Why did your agency decide not to purchase service through ACCESS?

39. Does the agency have any plans to consider purchasing transportation service from ACCESS in the future?

63

- 1. No
- 2. Yes (Please explain.)

40. Are there any special factors about your agency or restrictions that would prevent your agency from using a coordinated transportation system? (Please explain) _____

41. Coordinating the transportation of human service agencies through vehicle sharing or centralized purchasing of transportation services can lead to many changes for the agency. Some of the possible changes are described in the sentences below. Please indicate whether you agree or disagree that these types of changes would occur if (or did occur when) your agency coordinated its transportation program with other agencies.

	(1) <u>Strongly</u> <u>Agree</u>	(2) <u>Somewhat</u> <u>Agree</u>	(3) <u>No</u> <u>Opinion</u>	(4) <u>Somewhat</u> <u>Disagree</u>	(5) <u>Strongly</u> <u>Disagree</u>	
a) Agency transportation costs would decrease.	—	—	—	—	—	<u>64</u>
b) Drivers in a coordinated program would be as sensitive as our current drivers are.	—	—	—	—	—	<u>65</u>
c) The agency would receive a lower quality of transportation service than it currently receives.	—	—	—	—	—	<u>66</u>
d) The agency would be more flexible in the <u>amount</u> of service it could provide to its clients.	—	—	—	—	—	<u>67</u>
e) The agency would be more flexible in <u>when</u> it could provide service for its clients.	—	—	—	—	—	<u>68</u>
f) The agency would have less control over its transportation program.	—	—	—	—	—	<u>69</u>
g) The agency would be able to keep its vehicles in use for longer portions of the day.*	—	—	—	—	—	<u>70</u>
h) The agency would be able to increase ridesharing (the number of passengers in a vehicle).	—	—	—	—	—	<u>71</u>
i) The agency would have difficulty planning a budget for its transportation programs.	—	—	—	—	—	<u>72</u>

*If your agency has no vehicles, please skip over this statement.

Please feel free to elaborate on any of the answers you gave on this survey or to add any thoughts you or others in your organization may have concerning agency transportation.

THANK YOU FOR YOUR COOPERATION!

If you would like additional information about ACCESS, please indicate below the person to whom the information should be sent.

_____ Yes, I would like additional information about ACCESS.
Please send it to:

SURVEY OF AGENCIES FORMERLY AFFILIATED WITH
ACCESS

Please Note:
This Column
Is For Use
In Survey
Tabulation.

Part 1: QUESTIONS ABOUT YOUR AGENCY

PLEASE ANSWER THE FOLLOWING QUESTIONS ABOUT YOUR AGENCY AND ITS CLIENTS.

1
1

Agency Name: _____
Address: _____
Telephone: _____
Contact Person: _____ Title: _____

2 3 4

1. Is your agency affiliated with other Allegheny County human service agencies?

5

1: _____ No
2: _____ Yes → Which Agencies? _____

6 7

2. Which of the following would best describe your organization?
(Please check the one that applies.)

8

1. _____ Private, for profit 3. _____ Public
2. _____ Private, not-for-profit 4. _____ Other (Please specify)

3. What are the major funding sources of your agency and what percentage of total agency funds comes from each source?

<u>Funding Source</u>	<u>Percentage of agency funds</u>	
_____	_____	<u>9 10</u>
_____	_____	<u>11 12</u>
_____	_____	<u>13 14</u>
_____	_____	<u>15 16</u>
_____	_____	<u>17 18</u>
All Sources	100 %	

4. What type of clients does your agency serve? (Please check all that apply.)

- | | | |
|----------|-------------------------------|-----------|
| 1. _____ | Elderly | <u>19</u> |
| 2. _____ | Physically Handicapped | <u>20</u> |
| 3. _____ | Mentally Handicapped | <u>21</u> |
| 4. _____ | Others (Please Specify) _____ | <u>22</u> |
| | _____ | |
| | _____ | |

5. What type of services does your agency provide? (Please check all that apply.)

- | | | | | |
|----------|-------------------|----------|-------------------------|--------------|
| 1. _____ | Counseling | 5. _____ | Physical Rehabilitation | <u>23 24</u> |
| 2. _____ | Group Meals | 6. _____ | Vocational Training | <u>25 26</u> |
| 3. _____ | Recreation/Social | 7. _____ | Economic Assistance | <u>27 28</u> |
| 4. _____ | Education | 8. _____ | Other (Please specify.) | <u>29 30</u> |
| | | | _____ | |

6. Approximately how many clients does your agency currently serve?

_____ clients 31 32 33

7. What percentage of these clients use agency services at least once a week?

34 35

_____ percent

8. What requirements must individuals meet to be served by your agency?
(Please check all that apply.)

36 37

1. _____ They must be over age _____. (Please fill in.)

38 39

2. _____ They must meet specific income guidelines.

3. _____ They must be physically or mentally handicapped.
(Please describe type of handicap, if any) _____

40 41

4. _____ They must live in a specific area.

42 43

5. _____ They must be of a particular religious faith.

6. _____ They must be of a particular profession.

7. _____ They must be referred by another agency.

8. _____ No requirements for clients.

9. _____ Other requirements. (Please specify.) _____

9. What percentage of your clients are ambulatory and what percentage require the use of a wheelchair?

_____ percent are ambulatory.

44 45

_____ percent require the use of a wheelchair.

46 47

Part 2: QUESTIONS ABOUT THE AGENCY'S TRANSPORTATION SERVICES

PLEASE ANSWER THE FOLLOWING QUESTIONS ABOUT THE TRANSPORTATION SERVICES PROVIDED BY YOUR AGENCY

10. Does your agency provide transportation to clients in any of the following ways?

Operate agency vehicles?	1. <input type="checkbox"/>	Yes	2. <input type="checkbox"/>	No	48
Purchase transportation services?	1. <input type="checkbox"/>	Yes	2. <input type="checkbox"/>	No	49
Use volunteers or staff who drive their own vehicles?	1. <input type="checkbox"/>	Yes	2. <input type="checkbox"/>	No	50
Reimburse clients for transportation expenses?	1. <input type="checkbox"/>	Yes	2. <input type="checkbox"/>	No	51

11. Are you able to serve all your clients' requests for service?

1. <input type="checkbox"/>	Yes		52
2. <input type="checkbox"/>	No	→ Why not? (Please explain.)	

12. Are decisions concerning the agency's transportation services made at the agency?

1. <input type="checkbox"/>	Yes		
2. <input type="checkbox"/>	No	→ Who makes transportation decisions for the agency?	53

		_____	54

13. Considering all carriers and vehicles, for what purposes does your agency provide transportation? (Check all that apply.)

1. <input type="checkbox"/>	Travel to group-meal sites	55	56
2. <input type="checkbox"/>	Travel to medical appointment, physical rehabilitation, etc.	57	58
3. <input type="checkbox"/>	Travel to group social outings and events		
4. <input type="checkbox"/>	Travel to employment		
5. <input type="checkbox"/>	Travel for shopping purposes		
6. <input type="checkbox"/>	Travel to educational classes		
7. <input type="checkbox"/>	The agency provides transportation for all purposes		
8. <input type="checkbox"/>	The agency provides transportation for other purposes. (Please list these.)		

14. Does your agency own or operate any vehicles?
 1. _____ Yes 61
 2. _____ No → PLEASE SKIP TO QUESTION 24 AND CONTINUE SURVEY.
15. How many vehicles does your agency own or operate?
 _____ vehicles (Please fill in number.) 62 63
16. How many of these vehicles are ramp or lift equipped?
 _____ vehicles (Please fill in number.) 64 65
17. Are advance reservations required for transportation services in agency vehicles?
 1. _____ No 66
 2. _____ Yes → How far in advance? _____ hours 67 68
18. Please complete the following sentences by filling in the number of each type of vehicle owned or operated by your agency. 69 70
 The agency owns or operates _____ sedans. 71 72
 The agency owns or operates _____ vans. 73 74
 The agency owns or operates _____ buses.
19. Of the vehicles that your agency owns or operates, how many does the agency own? 75 76
 _____ vehicles 2
1
2 3 4

20. Where did your agency obtain funds to purchase any or all of these vehicles? (Please check as many as apply.) 5 6
- 1. Federal Section 16(b)(2) grants 7 8
 - 2. General agency funds
 - 3. State funds 9 10
 - 4. County funds
 - 5. Local (city or town) funds
 - 6. Other (Please describe) _____
-
21. Who owns the vehicles, if any, that your agency operates but does not own?
- _____
-
22. Are there any restrictions on your agency's use of any of its vehicles? 11
- 1. No
 - 2. Yes → What are these restrictions?
- _____
-
23. For what purposes does your agency use its own vehicles? (Please check all that apply.) 12 13
- 1. Transport clients to group meal sites 14 15
 - 2. Transport clients to medical appointment, physical rehabilitation centers, etc. 16 17
 - 3. Transport clients to group social outings and events 18 19
 - 4. Transport clients to their jobs
 - 5. Transport clients to educational classes
 - 6. Transport clients for shopping purposes
 - 7. Other client activities (Please describe.)
-
8. The agency does not use its own vehicles to transport clients.
24. Does your agency purchase transportation services from providers other than ACCESS either directly or through a central agency such as AS/AAA? (ACCESS is the shared-ride transportation system sponsored by the Port Authority of Allegheny County.) 20
- 1. Yes
 - 2. No → PLEASE SKIP TO QUESTION 29 AND CONTINUE SURVEY.

25. From which carrier or carriers does your agency purchase service?
(Please check all that apply but do not include carriers that you use
only through a contract with ACCESS.)

21 22

- | | | | |
|-----------------------------|---|--|------------------|
| 1. <input type="checkbox"/> | Yellow Cab | 6. <input type="checkbox"/> | Diamond Cab |
| 2. <input type="checkbox"/> | Tube City Taxi | 7. <input type="checkbox"/> | People's Cab |
| 3. <input type="checkbox"/> | Colonial Taxi | 8. <input type="checkbox"/> | Tri-Borough Taxi |
| 4. <input type="checkbox"/> | Magic Carpet | 9. <input type="checkbox"/> | Others |
| 5. <input type="checkbox"/> | North Hills
Transportation
Services | (Please specify carriers.)

_____ | |

23 24

26. Are advance reservations required for service by this carrier(s)?

1. No
2. Yes → How far in advance? _____ hours.

25

27. Approximately how much does your agency pay on average for a one-way
client trip provided by these carriers?

26 27

\$ _____ per one-way trip

28 29 30 31

28. How is your agency charged for service from these carriers?

1. Agency is charged a pre-determined price for each trip.
2. Agency is charged the metered fare.
3. Agency is charged for service on a per-hour basis
4. Other (Please describe) _____

32

29. Approximately how many one-way trips per week does your agency
provide for its clients. (Please fill in the blanks.)

using carriers other than ACCESS? _____ one-way trips per week
using ACCESS? _____ one-way trips per week
using agency-owned or operated vehicles? _____ one-way trips per
week

33 34 35

36 37 38

39 40 41

30. Approximately what percentage of all trips provided by your agency are
groups trips (i.e., organized groups of 2 or more persons)?

42 43

_____ percent are group trips.

31. How much, if anything, does your agency charge its clients for transportation services?

44 45 46

\$ _____ per one-way trip

32. Approximately how much did your agency spend in 1981 on transportation services for its clients?

47 48 49 50 51 52

\$ _____

33. Approximately what percentage is this of the total agency budget?

53 54

_____ percent

34. How much does the agency expect to spend on transportation services in 1982?

55 56 57 58 59 60

\$ _____

35. We are interested in the days and times during which your agency provides trips for its clients. Please indicate on the spaces below approximately the number of agency trips made during the following time periods this week.

TIME PERIOD	DAY OF THE WEEK						
	Sunday	Monday	Tuesday	Wednesday	Thursday	Friday	Saturday
7:00 a.m.-9:00 a.m.	_____	_____	_____	_____	_____	_____	_____
9:00 a.m.-2:00 p.m.	_____	_____	_____	_____	_____	_____	_____
2:00 p.m.-5:00 p.m.	_____	_____	_____	_____	_____	_____	_____
5:00 p.m.-7:00 p.m.	_____	_____	_____	_____	_____	_____	_____
After 7:00 p.m.	_____	_____	_____	_____	_____	_____	_____

Part 3 AGENCY EXPERIENCE WITH ACCESS

PLEASE ANSWER THE FOLLOWING QUESTIONS ABOUT YOUR EXPERIENCES WITH ACCESS.

36. On what date did your agency begin to use ACCESS to provide transportation services to your clients? (Please fill in month and year.)

61 62 63 64

37. Why did your agency originally decide to use ACCESS service?

38. On what date did your agency stop requesting trips for its clients through ACCESS? (Please fill in month and year.)

65 66 67 68

39. Why did your agency stop using ACCESS service on a regular basis?

40. For what trip purposes did your agency use ACCESS service? (Please check all that apply.)

- | | | |
|--|---|---------------------|
| 1. <input type="checkbox"/> All trips | 5. <input type="checkbox"/> Social/recreational | |
| 2. <input type="checkbox"/> Nutrition | 6. <input type="checkbox"/> Education | <u>69</u> <u>70</u> |
| 3. <input type="checkbox"/> Medical | 7. <input type="checkbox"/> Grocery shopping | |
| 4. <input type="checkbox"/> Training or employment | 8. <input type="checkbox"/> Other purposes (Please describe.) _____ | <u>71</u> <u>72</u> |
| | | <u>73</u> <u>74</u> |

75

41. Did your agency have any difficulties with ACCESS' third-party billing procedures? (Please check one.)

76

- 1. No difficulties.
- 2. Minor difficulties that were resolved satisfactorily.
- 3. Major difficulties that were resolved.
(Please describe.) _____

- 4. Difficulties that were not resolved.
(Please describe.) _____

3
1

2 3 4

42. What transportation providers or services did your agency use for the majority of its trips before contracting with ACCESS? (Please check one.)

5

- 1. Used agency vehicles
- 2. Magic Carpet
- 3. Yellow Cab
- 4. Tube City Taxi
- 5. Colonial Taxi
- 6. Diamond Cab
- 7. People's Cab
- 8. Tri-Borough Taxi
- 9. Other (Please specify.) _____

43. Which ACCESS carrier did the agency use for the majority of its ACCESS trips? (Please check one.)

6 7

- 1. Magic Carpet
- 2. Yellow Cab
- 3. Tube City Taxi
- 4. Colonial
- 5. Focus on Renewal
- 6. Steelworkers Oldtimers Foundation
- 7. The Center
- 8. Chartiers
- 9. Tri-Borough Taxi
- 10. North Hill Transportation Services
- 11. Amram Enterprises

44. What transportation providers or services does your agency use now for the majority of its trips? (Please check one.)

- | | |
|--|---|
| 1. <input type="checkbox"/> Use agency vehicles. | 6. <input type="checkbox"/> Diamond Cab |
| 2. <input type="checkbox"/> Magic Carpet | 7. <input type="checkbox"/> People's Cab |
| 3. <input type="checkbox"/> Yellow Cab | 8. <input type="checkbox"/> Tri-Borough Taxi |
| 4. <input type="checkbox"/> Tube City Taxi | 9. <input type="checkbox"/> Other (Please specify.) |
| 5. <input type="checkbox"/> Colonial Taxi | |
-

8

45. Below is a list of ACCESS service characteristics. Please indicate if your agency found these characteristics very useful, somewhat useful, or if they had no effect on the agency.

	(1) <u>Very Useful To Agency</u>	(2) <u>Somewhat Useful To Agency</u>	(3) No <u>Effect on the Agency</u>	
Monthly ACCESS Accounting Records	<input type="checkbox"/>	<input type="checkbox"/>	<input type="checkbox"/>	<u>9</u>
6:00 A.M.--12:00 P.M. Service	<input type="checkbox"/>	<input type="checkbox"/>	<input type="checkbox"/>	<u>10</u>
Sunday-Saturday Service	<input type="checkbox"/>	<input type="checkbox"/>	<input type="checkbox"/>	<u>11</u>
ACCESS Carrier Insurance	<input type="checkbox"/>	<input type="checkbox"/>	<input type="checkbox"/>	<u>12</u>

46. Below is a second list of ACCESS service characteristics. Please indicate how these service characteristics of ACCESS differ from the service your agency is currently using.

	(1) Much Better Than Current Service	(2) Somewhat Better Than Current Service	(3) The Same As Current Service	(4) Somewhat Worse Than Current Service	(5) Much Worse Than Current Service	
Driver Sensitivity	_____	_____	_____	_____	_____	<u>13</u>
Complaint Procedures	_____	_____	_____	_____	_____	<u>14</u>
Time Spent Waiting for Vehicle to Arrive	_____	_____	_____	_____	_____	<u>15</u>
Time Spent in Vehicle	_____	_____	_____	_____	_____	<u>16</u>
Vehicle Safety	_____	_____	_____	_____	_____	<u>17</u>
Availability of Service When Needed	_____	_____	_____	_____	_____	<u>18</u>
Service Hours	_____	_____	_____	_____	_____	<u>19</u>
Provision of Door-To- Door Service	_____	_____	_____	_____	_____	<u>20</u>
Accessible Vehicles	_____	_____	_____	_____	_____	<u>21</u>

47. Please indicate whether you agree or disagree that the agency received any of the following benefits while it contracted with ACCESS.

	(1)	(2)	(3)	
	<u>Agree</u>	<u>Disagree</u>	<u>No Opinion</u>	
a) Agency transportation costs increased more slowly than they would have without ACCESS.	—	—	—	<u>22</u>
b) The agency received a similar or higher quality service from ACCESS than it did before.	—	—	—	<u>23</u>
c) With ACCESS, the agency was more flexible in the amount of service it could provide for its clients, than it was before.	—	—	—	<u>24</u>
d) With ACCESS, the agency was more flexible in when it could provide service for its clients, than it was before.	—	—	—	<u>25</u>
e) The agency was able to use its vehicles more efficiently by using ACCESS to provide single-passenger trips.*	—	—	—	<u>26</u>
f) Scheduling trips with ACCESS was easier than before.	—	—	—	<u>27</u>
g) It was easier to register service complaints with ACCESS than with our previous service.	—	—	—	<u>28</u>
h) Complaints were resolved by ACCESS in a more satisfactory manner than before.	—	—	—	<u>29</u>
i) ACCESS was an important supplement to our other vehicles when a vehicle broke down or a driver was unavailable.*	—	—	—	<u>30</u>
j) ACCESS negotiated with carriers more successfully than an individual agency can.	—	—	—	<u>31</u>

*If your agency has no vehicles of its own, please skip over this statement.

Please feel free to elaborate on any of the answers you gave in this survey or to add any thoughts you or others in your organization may have concerning agency transportation.

THANK YOU FOR YOUR COOPERATION!

☆ U. S. GOVERNMENT PRINTING OFFICE: 1985--500-628--610

HE 18.5 .A37
MTA- 84-35
Lovely, Mary
ACCESS

Form DOT F 172
FORMERLY FORM D

DOT LIBRARY



00353089